

<b>Model</b>	PLUS_UD_DBH602		
<b>Creator</b>	CHALEAMPHON	<b>.BCP Name</b>	INDEX_C3D_KITCHEN2
<b>Reviewer</b>		<b>Order</b>	H000986
<b>Approves</b>		<b>Date</b>	20/06/2024

## **PLUS\_UD\_DBH602-600X570X738**

**Colour**

05.111=ML.INDIAN ELIM MD762 (EVELYN)

**Edge**

01.407=1 AR8



- K2R-160171027
- K10R-160171040
- K20R-160171050
- K2L-160175179
- K20L-160175238
- K100L-160175192
- K100R-160175203
- K101R-160175214
- K1000L-160175227
- K40L-160175286
- K200L-160177857



<b>Model</b>	-PLUS_UD		
<b>Creator</b>	CHALEAMPHON	<b>.BCP Name</b>	INDEX_C3D_KITCHEN2
<b>Reviewer</b>		<b>Order</b>	H000986
<b>Approves</b>		<b>Date</b>	20/06/2024

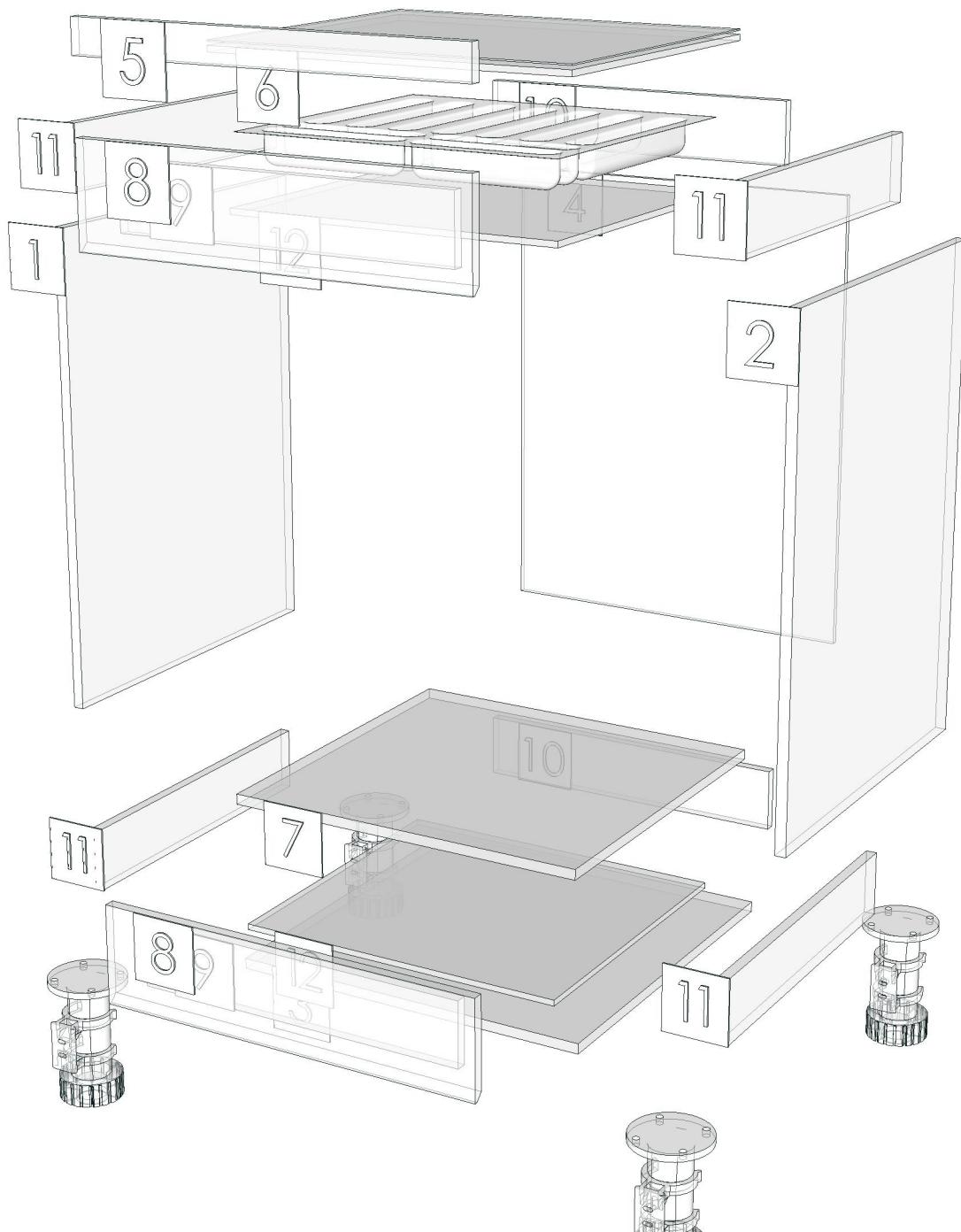

<b>Model</b>	PLUS_UD_DBO30_1		
<b>Creator</b>	CHALEAMPHON	<b>.BCP Name</b>	INDEX_C3D_KITCHEN2
<b>Reviewer</b>		<b>Order</b>	H002451
<b>Approves</b>		<b>Date</b>	26/03/2026

## **PLUS\_UD\_DBO30\_1-300X570X738**

**Colour**

20.14=ML GRAPHITE # MK3200 (PEARL)

**Edge**

01.206=1 GRAPHITE MD204



K200L-160177857

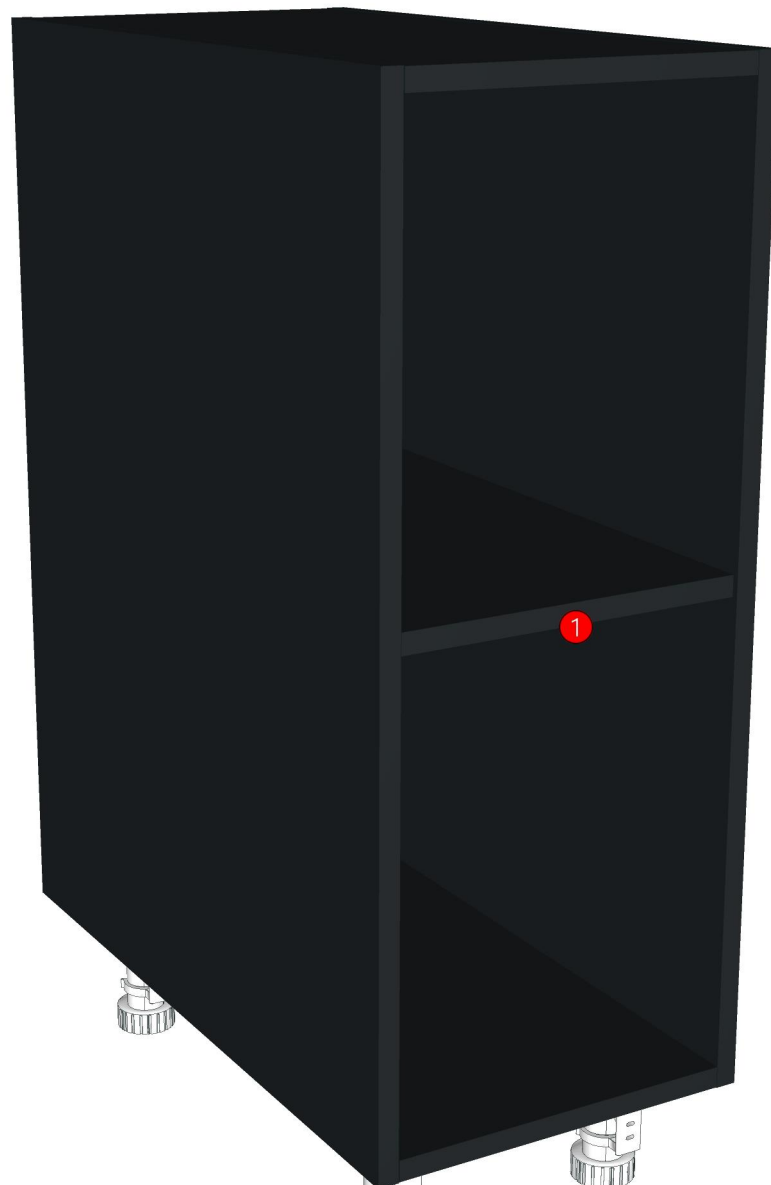

<b>Model</b>	-		
<b>Creator</b>	CHALEAMPHON	<b>.BCP Name</b>	INDEX_C3D_KITCHEN2
<b>Reviewer</b>		<b>Order</b>	H002451
<b>Approves</b>		<b>Date</b>	26/03/2026

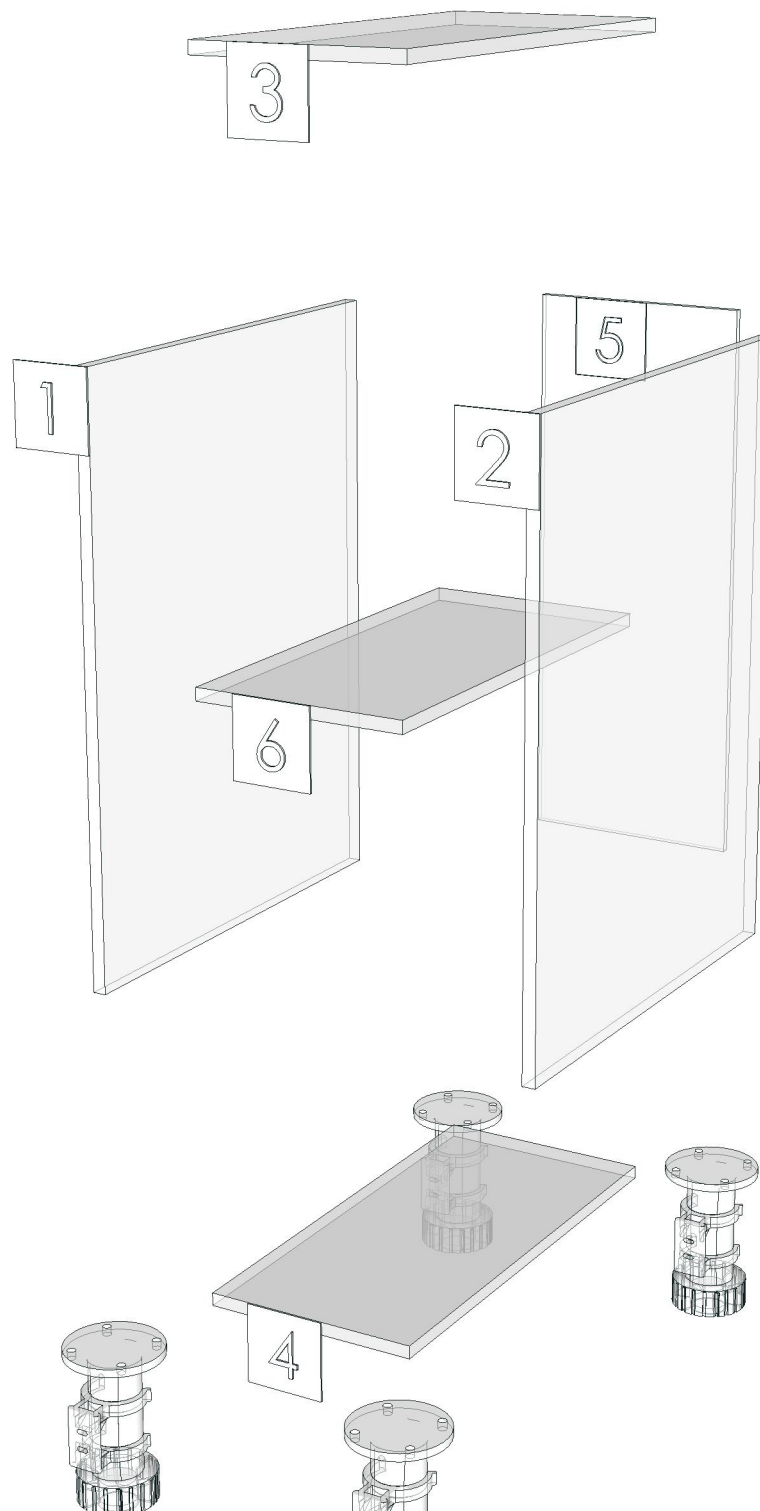

<b>Model</b>	PLUS_UD_DBS55		
<b>Creator</b>	CHALEAMPHON	<b>.BCP Name</b>	INDEX_C3D_KITCHEN2
<b>Reviewer</b>		<b>Order</b>	H000989
<b>Approves</b>		<b>Date</b>	20/06/2024

## **PLUS\_UD\_DBS55-550X570X738**

**Colour**

05.111=ML.INDIAN ELIM MD762 (EVELYN)

**Edge**

01.407=1 AR8



- K10R-160171040
- K20R-160171050
- K20L-160175238
- K100L-160175192
- K100R-160175203
- K1000L-160157227
- K40L-160175286
- K200L-160177857



<b>Model</b>	-PLUS_UD		
<b>Creator</b>	CHALEAMPHON	<b>.BCP Name</b>	INDEX_C3D_KITCHEN2
<b>Reviewer</b>		<b>Order</b>	H000989
<b>Approves</b>		<b>Date</b>	20/06/2024

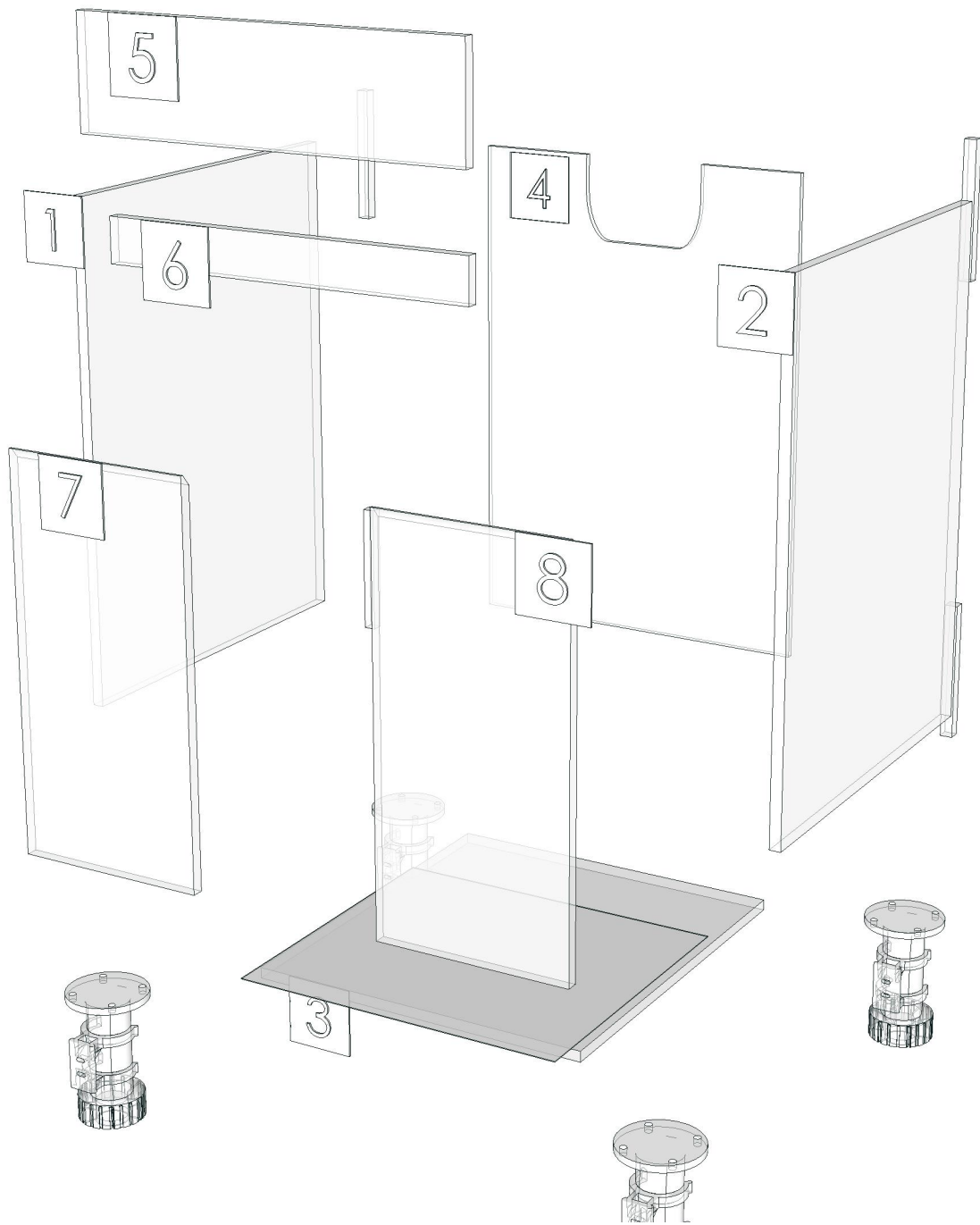

<b>Model</b>	PLUS_UD_DFB		
<b>Creator</b>	CHALEAMPON	<b>.BCP Name</b>	INDEX_C3D_KITCHEN2
<b>Reviewer</b>		<b>Order</b>	H000995
<b>Approves</b>		<b>Date</b>	26/06/2024

## **PLUS\_UD\_DFB-150X570X738**

**Colour**

05.111=ML.INDIAN ELIM MD762 (EVELYN)

**Edge**

01.407=1 AR8



K70L-160171061  
K40L-160175286  
K200L-160177857

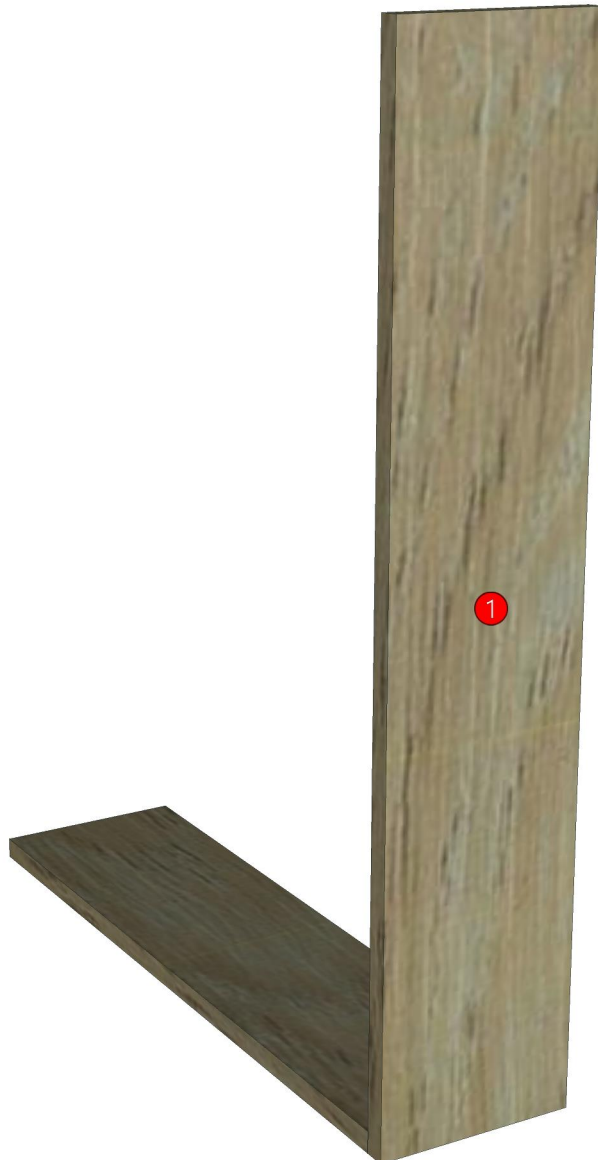

<b>Model</b>	-PLUS_UD		
<b>Creator</b>	CHALEAMPON	<b>.BCP Name</b>	INDEX_C3D_KITCHEN2
<b>Reviewer</b>		<b>Order</b>	H000995
<b>Approves</b>		<b>Date</b>	26/06/2024

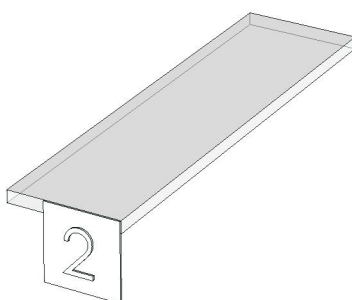
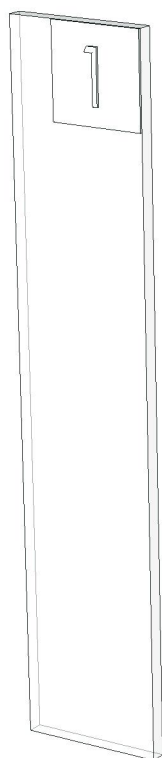

<b>Model</b>	PLUS_UD_DFL(BT)		
<b>Creator</b>	CHALEAMPON	<b>.BCP Name</b>	INDEX_C3D_KITCHEN2
<b>Reviewer</b>		<b>Order</b>	H002092
<b>Approves</b>		<b>Date</b>	28/10/2025

## PLUS\_UD\_DFL(BT)-150X300X650

**Colour**

05.74=ML.LIGHT TAUPE BT9 (PEARL)

**Edge**

01.393=1 BT9



K70L-160171061  
K40L-160175286  
K200L-160177857

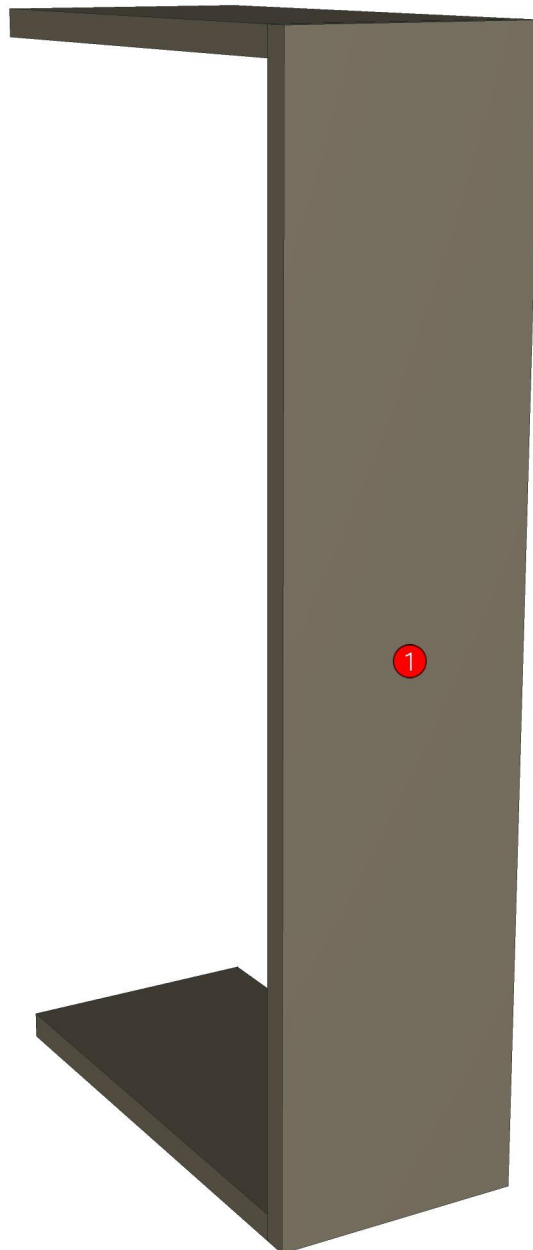

<b>Model</b>	-		
<b>Creator</b>	CHALEAMPON	<b>.BCP Name</b>	INDEX_C3D_KITCHEN2
<b>Reviewer</b>		<b>Order</b>	H002092
<b>Approves</b>		<b>Date</b>	28/10/2025

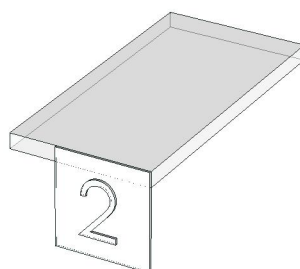
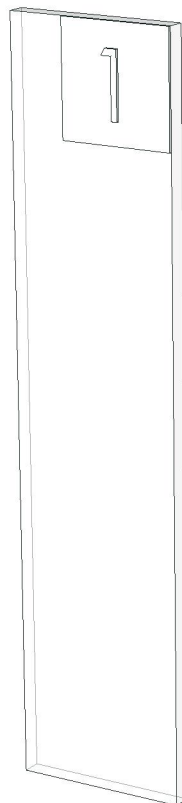
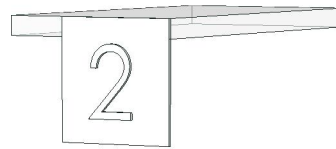

<b>Model</b>	PLUS_UD_DL145L_BT		
<b>Creator</b>	CHALEAMPHON	<b>.BCP Name</b>	INDEX_C3D_KITCHEN2
<b>Reviewer</b>		<b>Order</b>	H002452
<b>Approves</b>		<b>Date</b>	26/03/2026

## **PLUS\_UD\_DL145L\_BT-1450X300X650**

### **Colour**

05.74=ML.LIGHT TAUPE BT9 (PEARL)  
20.14=ML GRAPHITE # MK3200 (PEARL)  
05.01=ML WHITE VM1012 18/18

### **Edge**

01.393=1 BT9  
01.206=1 GRAPHITE MD204



K200L-160177857

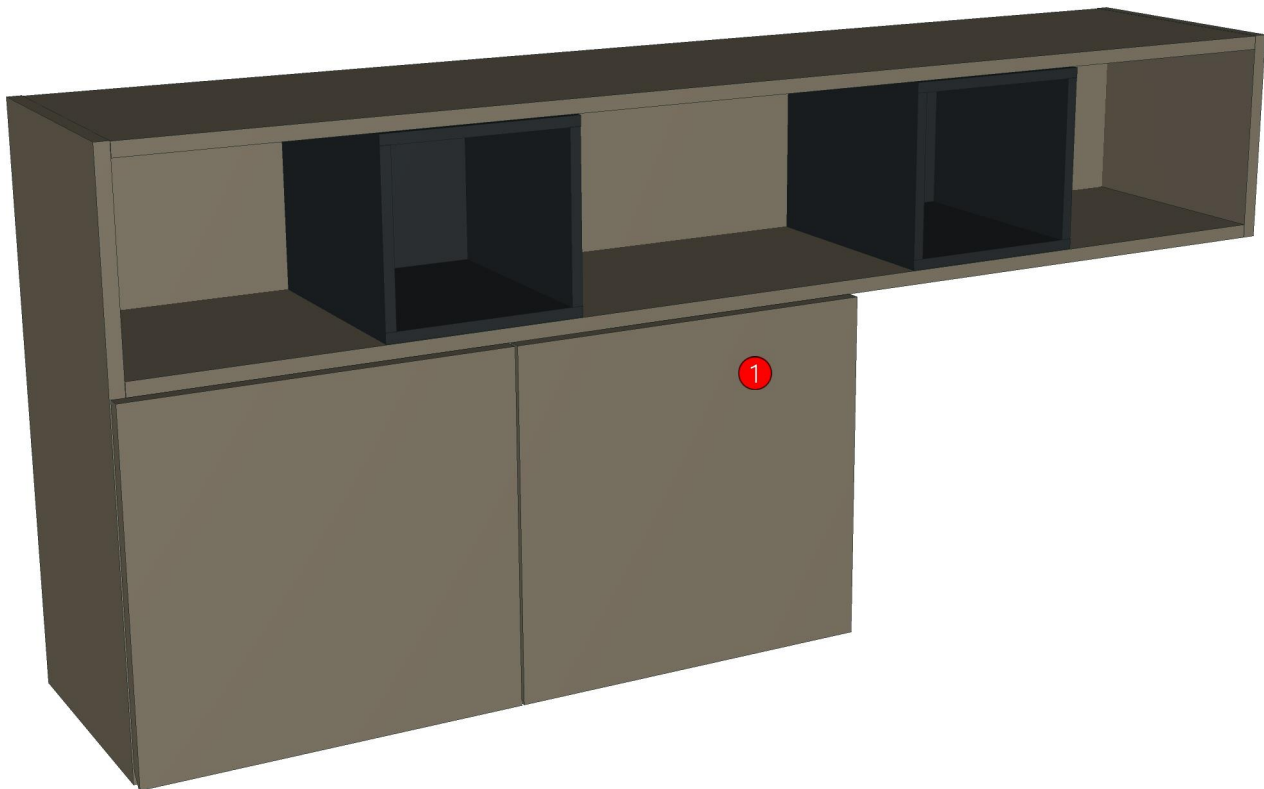

<b>Model</b>	-		
<b>Creator</b>	CHALEAMPHON	<b>.BCP Name</b>	INDEX_C3D_KITCHEN2
<b>Reviewer</b>		<b>Order</b>	H002452
<b>Approves</b>		<b>Date</b>	26/03/2026

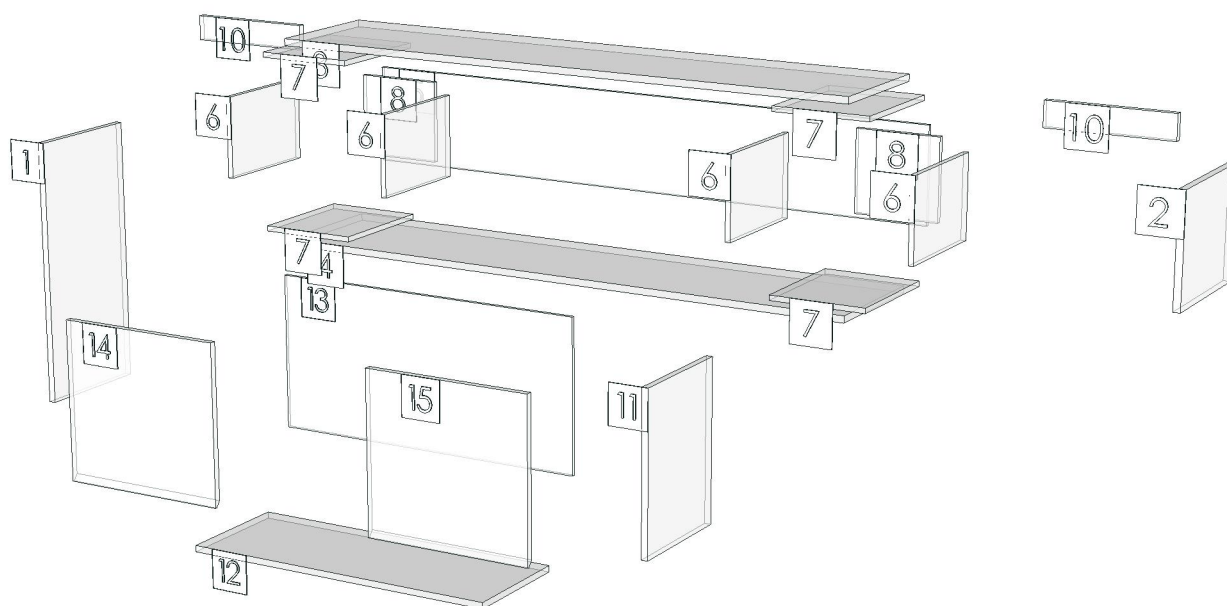

<b>Model</b>	PLUS_UD_DL60(H)AR		
<b>Creator</b>	CHALEAMPHON	<b>.BCP Name</b>	INDEX_C3D_KITCHEN2
<b>Reviewer</b>		<b>Order</b>	H002075
<b>Approves</b>		<b>Date</b>	23/10/2025

## **PLUS\_UD\_DL60(H)AR-600X300X355**

### **Colour**

05.111=ML.INDIAN ELIM MD762 (EVELYN)  
20.40=ML MK630 (PEARL)

### **Edge**

01.407=1 AR8



K10R-160171040  
K20R-160171050  
K20L-160175238  
K100L-160175192  
K100R-160175203  
K1000L-160175227  
K40L-160175286  
K200L-160177857



<b>Model</b>	-		
<b>Creator</b>	CHALEAMPHON	<b>.BCP Name</b>	INDEX_C3D_KITCHEN2
<b>Reviewer</b>		<b>Order</b>	H002075
<b>Approves</b>		<b>Date</b>	23/10/2025

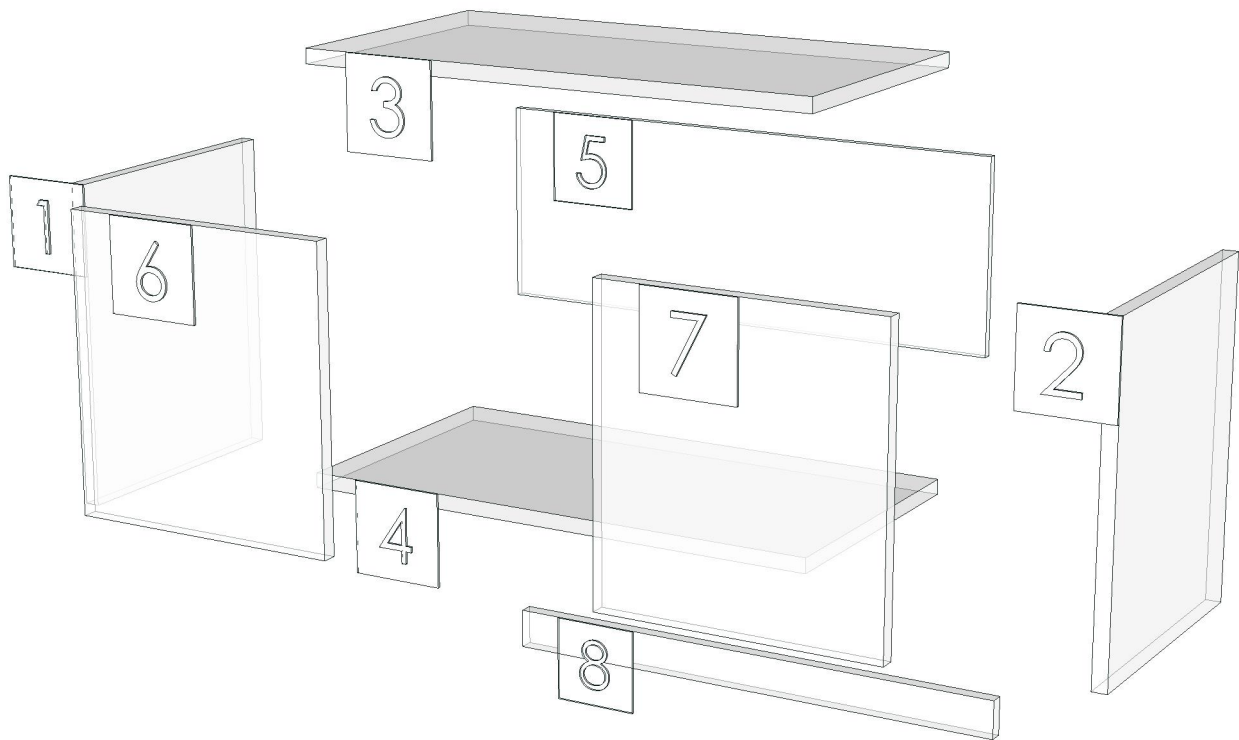

<b>Model</b>	PLUS_UD_DPLT_600		
<b>Creator</b>	CHALEAMPON	<b>.BCP Name</b>	INDEX_C3D_KITCHEN2
<b>Reviewer</b>		<b>Order</b>	H001012
<b>Approves</b>		<b>Date</b>	28/06/2024

## PLUS\_UD\_DPLT\_600-600X9X100

### Colour

05.85=ML.SWISS ELM CHAMPAGNE#AR8 SYNCHRONOUS

### Edge

01.407=1 AR8



- K2R-160171027
- K10R-160171040
- K20R-160171050
- K70L-160171061
- K2L-160175179
- K20L-160175238
- K100L-160175192
- K100R-160175203
- K101R-160175214
- K1000L-160175227
- K40L-160175286
- K200L-160177857



<b>Model</b>	PLUS_UD_DPLT_600		
<b>Creator</b>	CHALEAMPHON	<b>.BCP Name</b>	INDEX_C3D_KITCHEN2
<b>Reviewer</b>		<b>Order</b>	H001012
<b>Approves</b>		<b>Date</b>	28/06/2024

No.	Article No.	Description	Mat	Dimension	Cutting Size	Typepology	Skin
0	PLUS_UD_DPLT_600			600x100x9			
	PLUS_UD_DPLT_600-01	LEG	PB-ST	9x100x600	9X98X599;L2:W1	183000_STR=05.85_EDG=AR8-1	2

<b>Model</b>	PLUS_UD_DPLT-1550		
<b>Creator</b>	CHALEAMPON	<b>.BCP Name</b>	INDEX_C3D_KITCHEN2
<b>Reviewer</b>		<b>Order</b>	H002453
<b>Approves</b>		<b>Date</b>	26/03/2026

## **PLUS\_UD\_DPLT-1550-1550X9X100**

**Colour**

05.85=ML.SWISS ELM CHAMPAGNE#AR8 SYNCHRONOUS

**Edge**

01.407=1 AR8



K200L-160177857

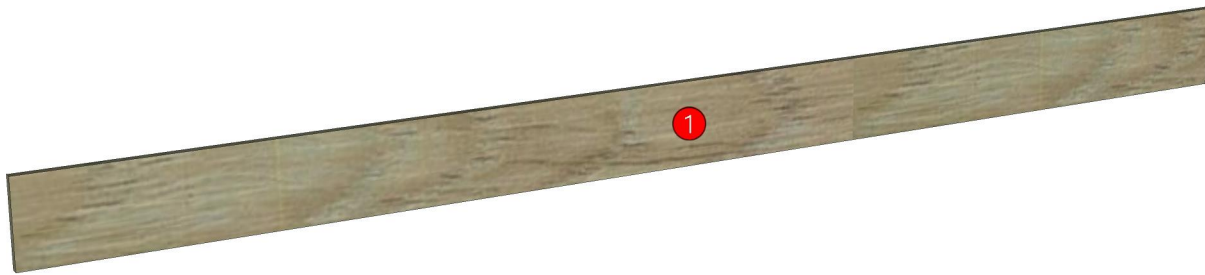

<b>Model</b>	PLUS_UD_DPLT-1550		
<b>Creator</b>	CHALEAMPHON	<b>.BCP Name</b>	INDEX_C3D_KITCHEN2
<b>Reviewer</b>		<b>Order</b>	H002453
<b>Approves</b>		<b>Date</b>	26/03/2026

No.	Article No.	Description	Mat	Dimension	Cutting Size	Typepology	Skin
0	PLUS_UD_DPLT-1550			1550x100x9			
	PLUS_UD_DPLT-1550-02	LEG	PB-ST	9x100x1550	9X98X1549;L2:W1	183000_STR=05.85_EDG=AR8-1	2