

<b>Model</b>	PLUS_UD_DBH602		
<b>Creator</b>	CHALEAMPHON	<b>.BCP Name</b>	INDEX_C3D_KITCHEN2
<b>Reviewer</b>		<b>Order</b>	H000986
<b>Approves</b>		<b>Date</b>	20/06/2024

## **PLUS\_UD\_DBH602-600X570X738**

**Colour**

05.111=ML.INDIAN ELIM MD762 (EVELYN)

**Edge**

01.407=1 AR8



- K2R-160171027
- K10R-160171040
- K20R-160171050
- K2L-160175179
- K20L-160175238
- K100L-160175192
- K100R-160175203
- K101R-160175214
- K1000L-160175227
- K40L-160175286
- K200L-160177857



<b>Model</b>	-PLUS_UD		
<b>Creator</b>	CHALEAMPHON	<b>.BCP Name</b>	INDEX_C3D_KITCHEN2
<b>Reviewer</b>		<b>Order</b>	H000986
<b>Approves</b>		<b>Date</b>	20/06/2024

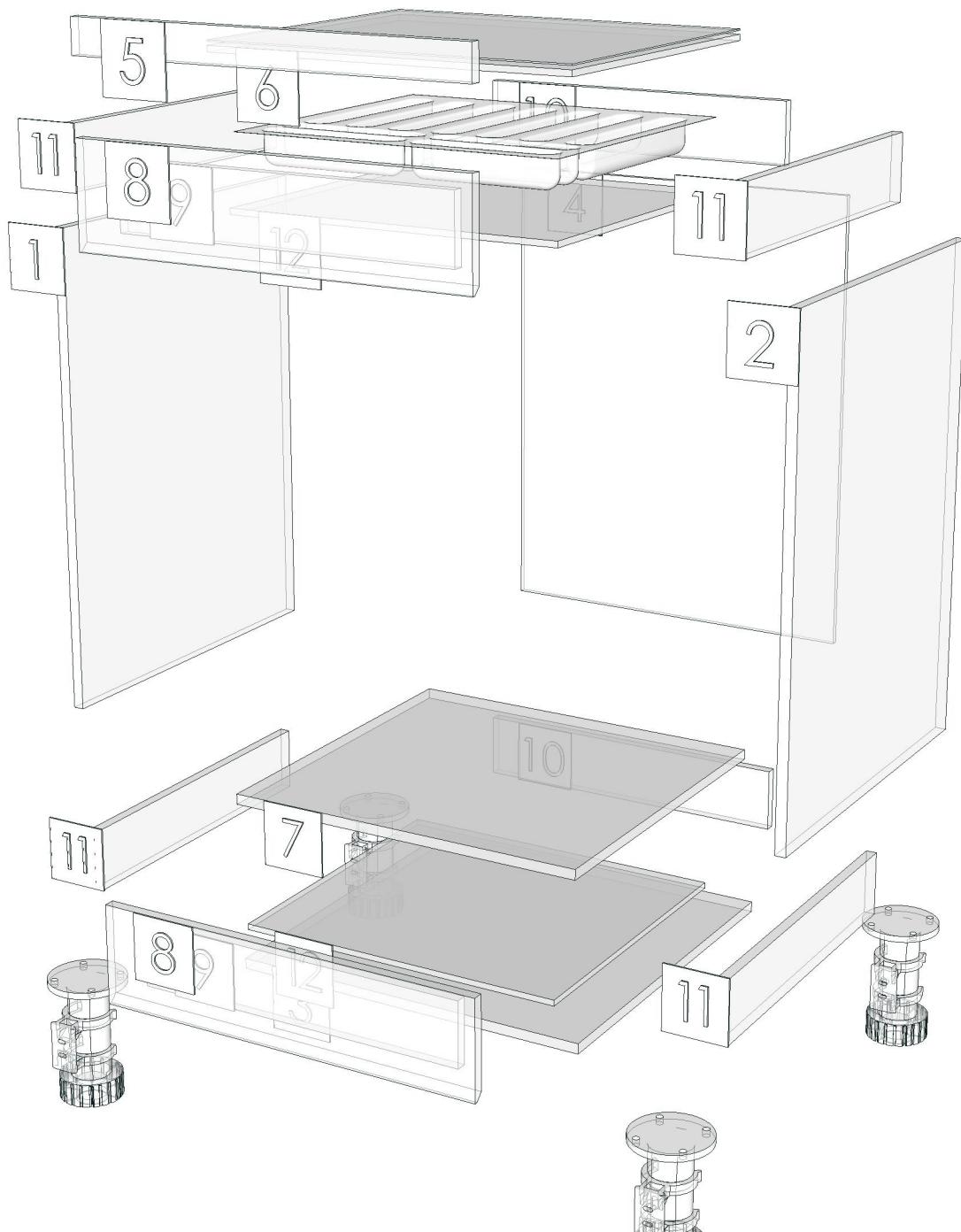

<b>Model</b>	PLUS_UD_DBO35_1		
<b>Creator</b>	CHALEAMPHON	<b>.BCP Name</b>	INDEX_C3D_KITCHEN2
<b>Reviewer</b>		<b>Order</b>	H000987
<b>Approves</b>		<b>Date</b>	20/06/2024

## PLUS\_UD\_DBO35\_1-350X570X738

**Colour**

20.14=ML GRAPHITE # MK3200 (PEARL)

**Edge**

01.206=1 GRAPHITE MD204



K20R-160171050  
K20L-160175238  
K1000L-160175227  
K40L-160175286

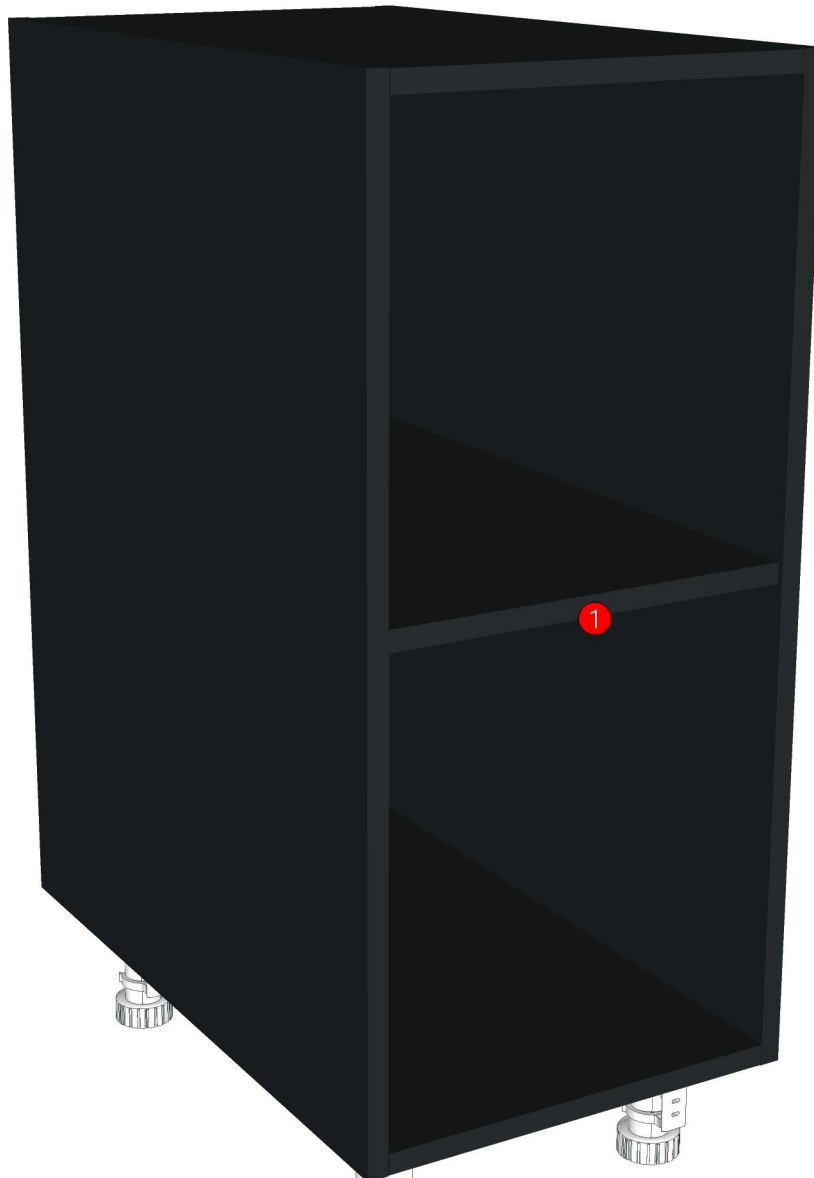

<b>Model</b>	-PLUS_UD		
<b>Creator</b>	CHALEAMPHON	<b>.BCP Name</b>	INDEX_C3D_KITCHEN2
<b>Reviewer</b>		<b>Order</b>	H000987
<b>Approves</b>		<b>Date</b>	20/06/2024

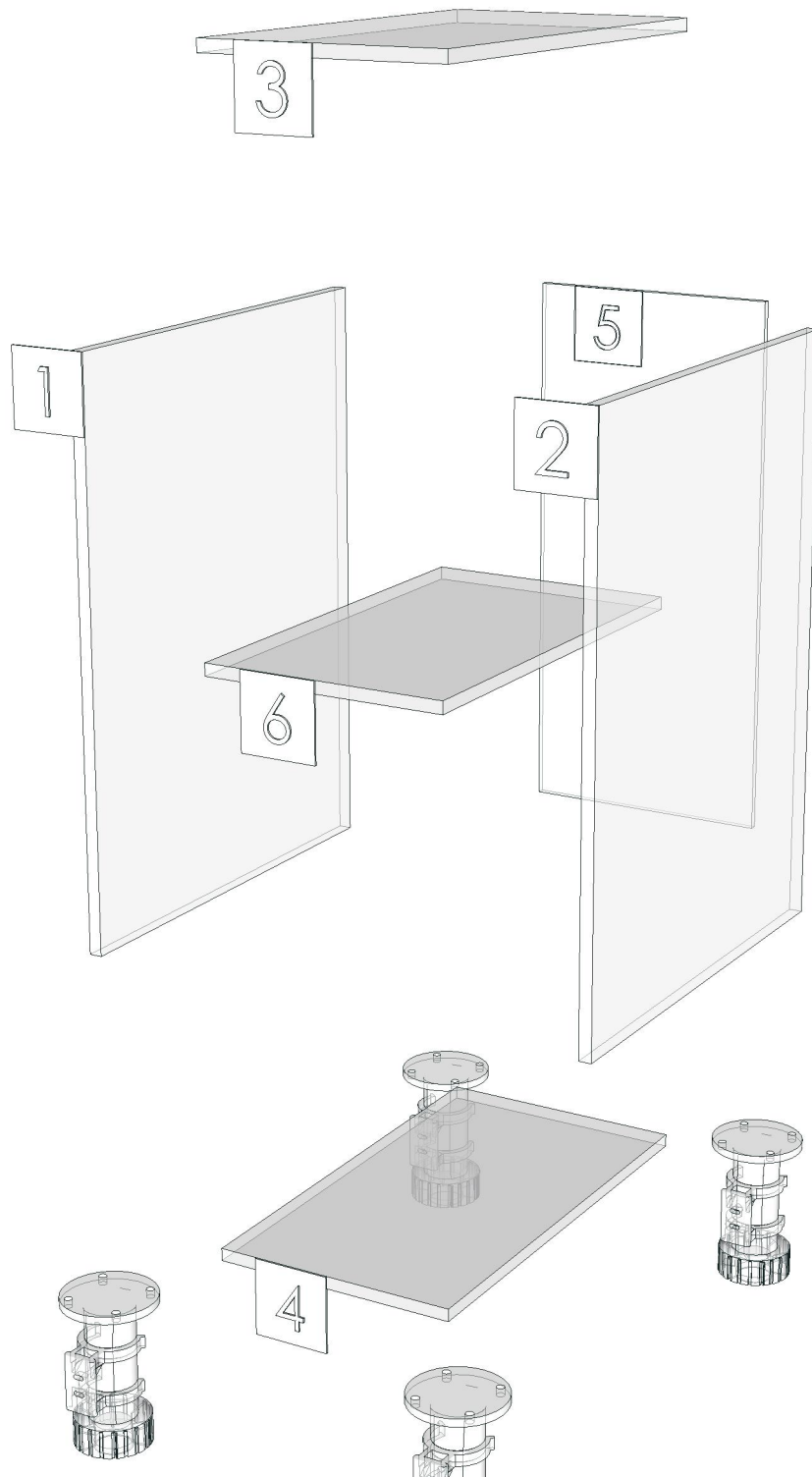

<b>Model</b>	PLUS_UD_DBS55		
<b>Creator</b>	CHALEAMPHON	<b>.BCP Name</b>	INDEX_C3D_KITCHEN2
<b>Reviewer</b>		<b>Order</b>	H000989
<b>Approves</b>		<b>Date</b>	20/06/2024

## **PLUS\_UD\_DBS55-550X570X738**

**Colour**

05.111=ML.INDIAN ELIM MD762 (EVELYN)

**Edge**

01.407=1 AR8



- K10R-160171040
- K20R-160171050
- K20L-160175238
- K100L-160175192
- K100R-160175203
- K1000L-160157227
- K40L-160175286
- K200L-160177857



<b>Model</b>	-PLUS_UD		
<b>Creator</b>	CHALEAMPHON	<b>.BCP Name</b>	INDEX_C3D_KITCHEN2
<b>Reviewer</b>		<b>Order</b>	H000989
<b>Approves</b>		<b>Date</b>	20/06/2024

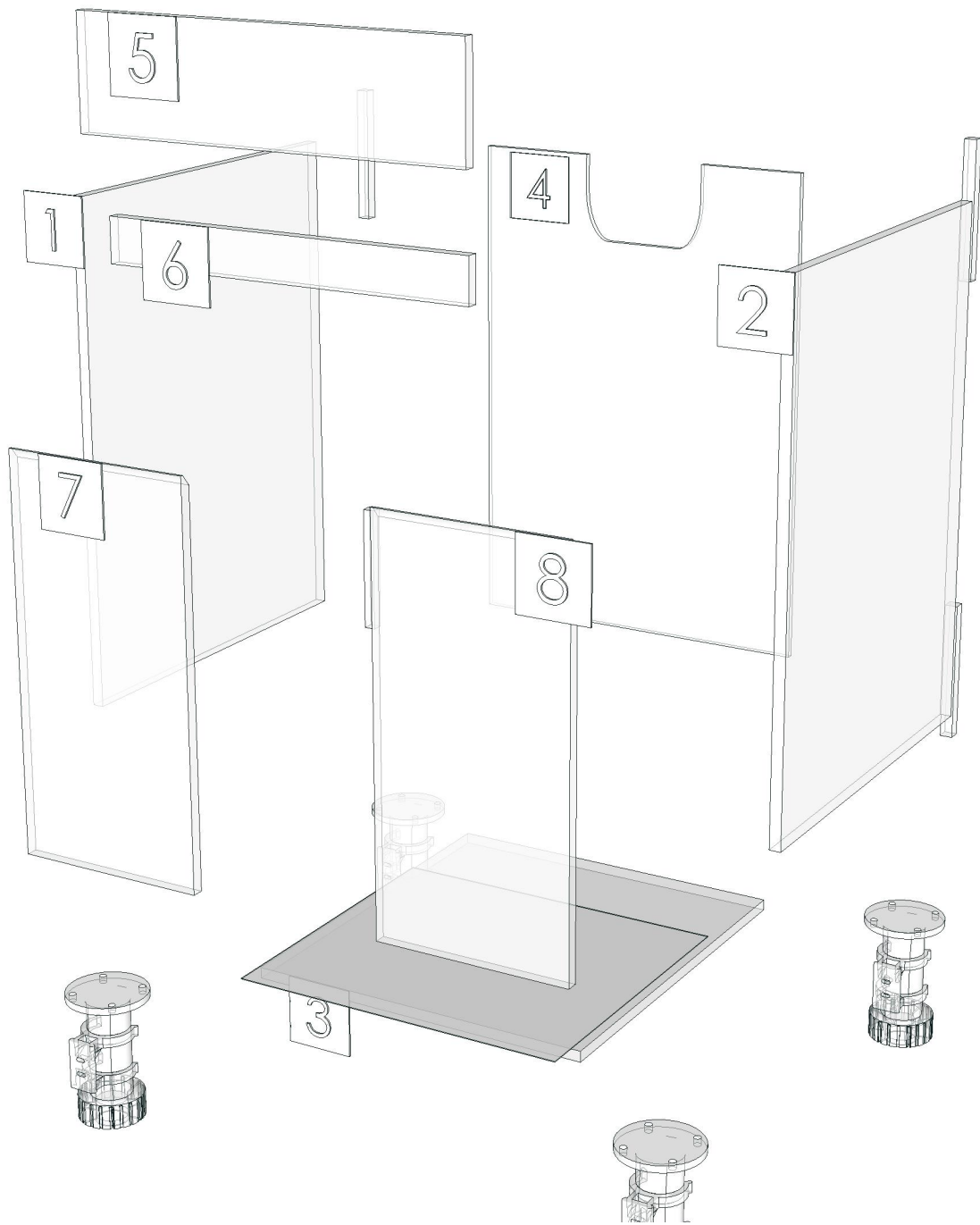

<b>Model</b>	PLUS_UD_DFB		
<b>Creator</b>	CHALEAMPON	<b>.BCP Name</b>	INDEX_C3D_KITCHEN2
<b>Reviewer</b>		<b>Order</b>	H000995
<b>Approves</b>		<b>Date</b>	26/06/2024

## **PLUS\_UD\_DFB-150X570X738**

**Colour**

05.111=ML.INDIAN ELIM MD762 (EVELYN)

**Edge**

01.407=1 AR8



K70L-160171061  
K40L-160175286  
K200L-160177857

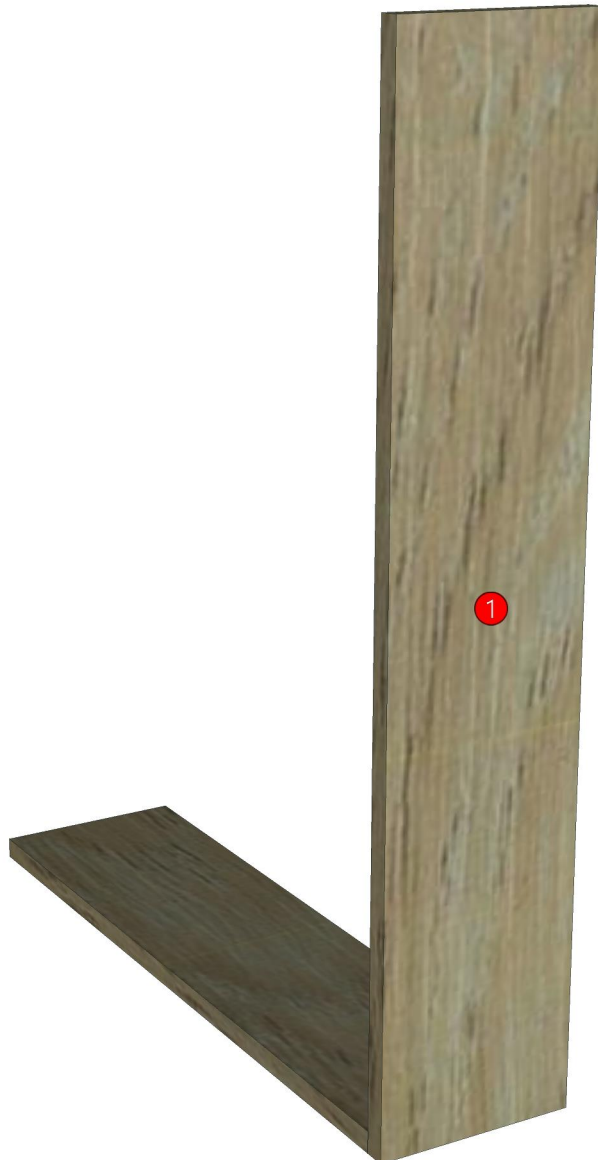

<b>Model</b>	-PLUS_UD		
<b>Creator</b>	CHALEAMPHON	<b>.BCP Name</b>	INDEX_C3D_KITCHEN2
<b>Reviewer</b>		<b>Order</b>	H000995
<b>Approves</b>		<b>Date</b>	26/06/2024

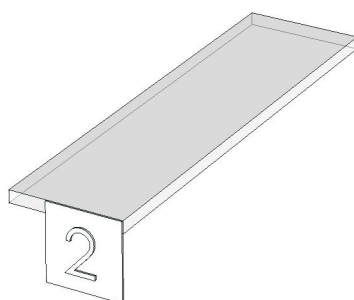
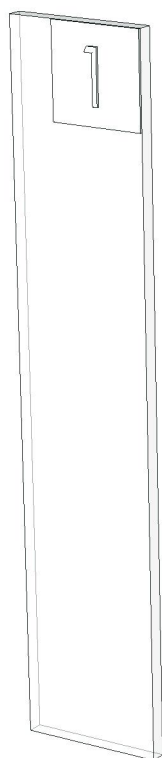

<b>Model</b>	PLUS_UD_DFL(BT)		
<b>Creator</b>	CHALEAMPON	<b>.BCP Name</b>	INDEX_C3D_KITCHEN2
<b>Reviewer</b>		<b>Order</b>	H002092
<b>Approves</b>		<b>Date</b>	28/10/2025

## PLUS\_UD\_DFL(BT)-150X300X650

**Colour**

05.74=ML.LIGHT TAUPE BT9 (PEARL)

**Edge**

01.393=1 BT9



K70L-160171061  
K40L-160175286  
K200L-160177857

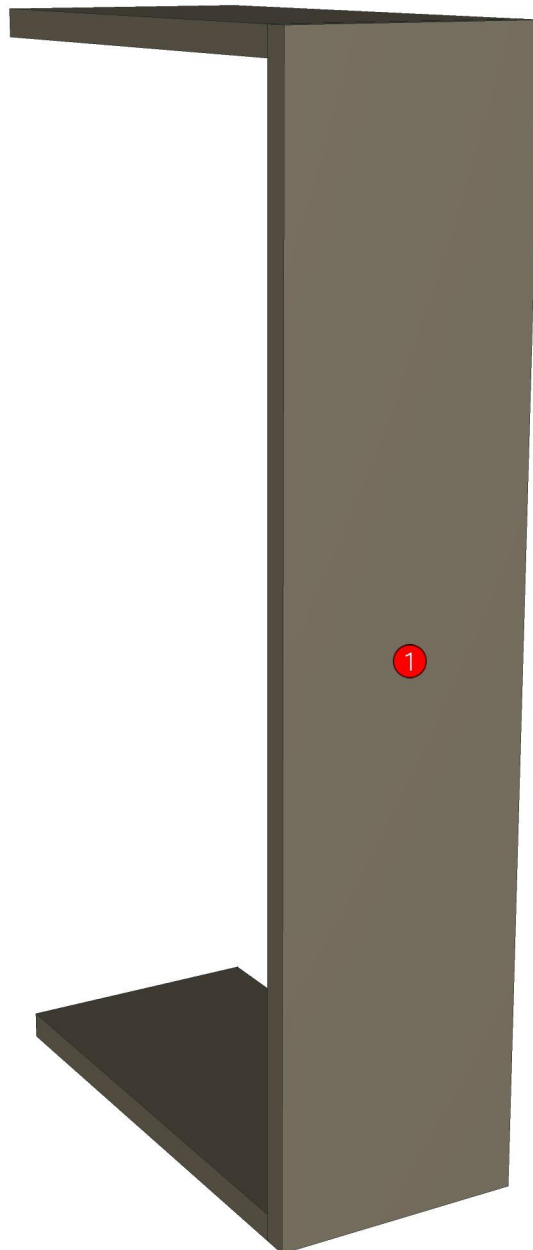

<b>Model</b>	-		
<b>Creator</b>	CHALEAMPON	<b>.BCP Name</b>	INDEX_C3D_KITCHEN2
<b>Reviewer</b>		<b>Order</b>	H002092
<b>Approves</b>		<b>Date</b>	28/10/2025

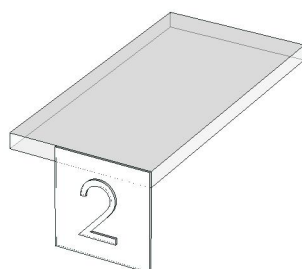
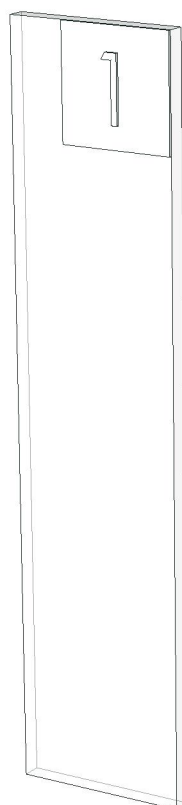

<b>Model</b>	PLUS_UD_DFW(BT)		
<b>Creator</b>	CHALEAMPHON	<b>.BCP Name</b>	INDEX_C3D_KITCHEN2
<b>Reviewer</b>		<b>Order</b>	H002236
<b>Approves</b>		<b>Date</b>	20/01/2026

## PLUS\_UD\_DFW(BT)-150X300X250

**Colour**

05.74=ML.LIGHT TAUPE BT9 (PEARL)

**Edge**

01.393=1 BT9



K40L-160175286

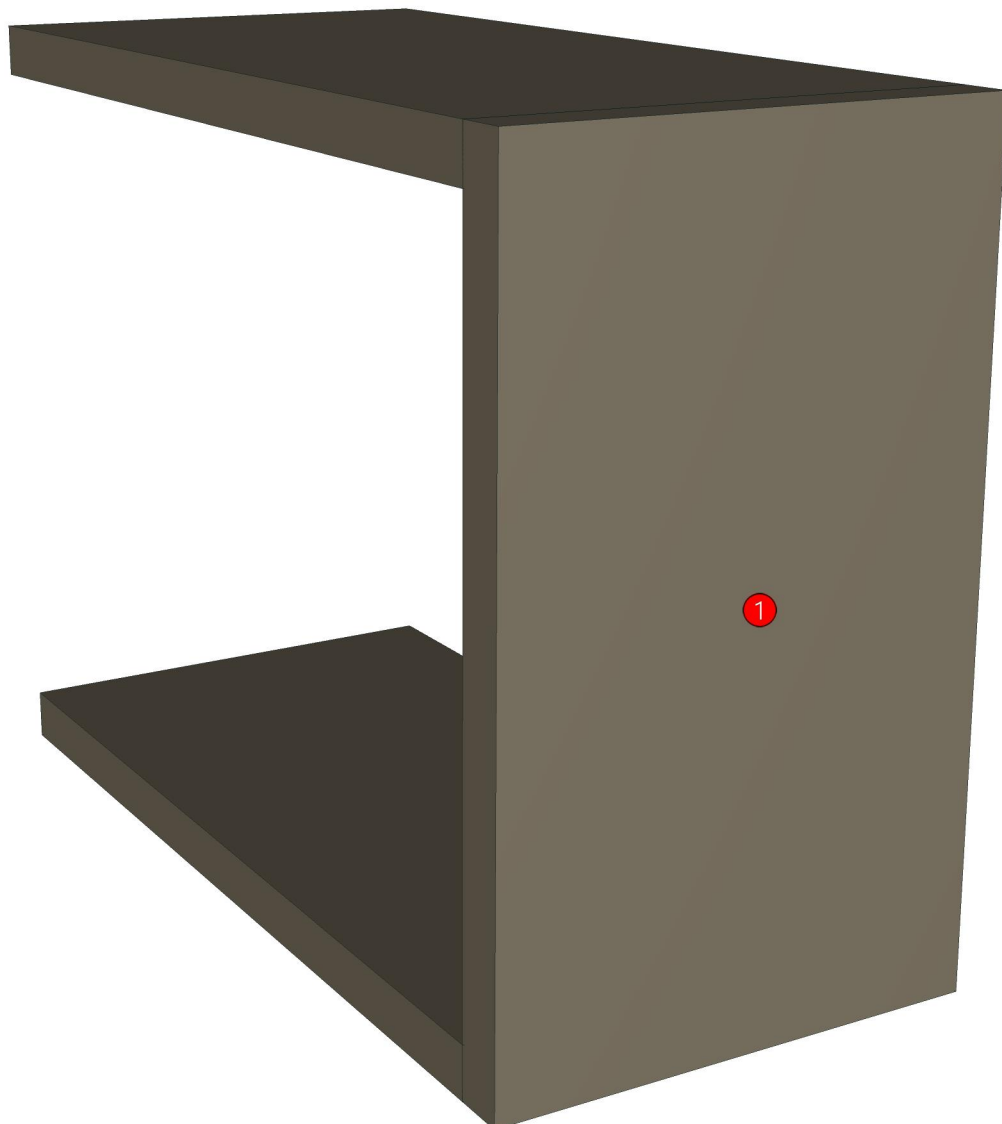

<b>Model</b>	-		
<b>Creator</b>	CHALEAMPON	<b>.BCP Name</b>	INDEX_C3D_KITCHEN2
<b>Reviewer</b>		<b>Order</b>	H002236
<b>Approves</b>		<b>Date</b>	20/01/2026

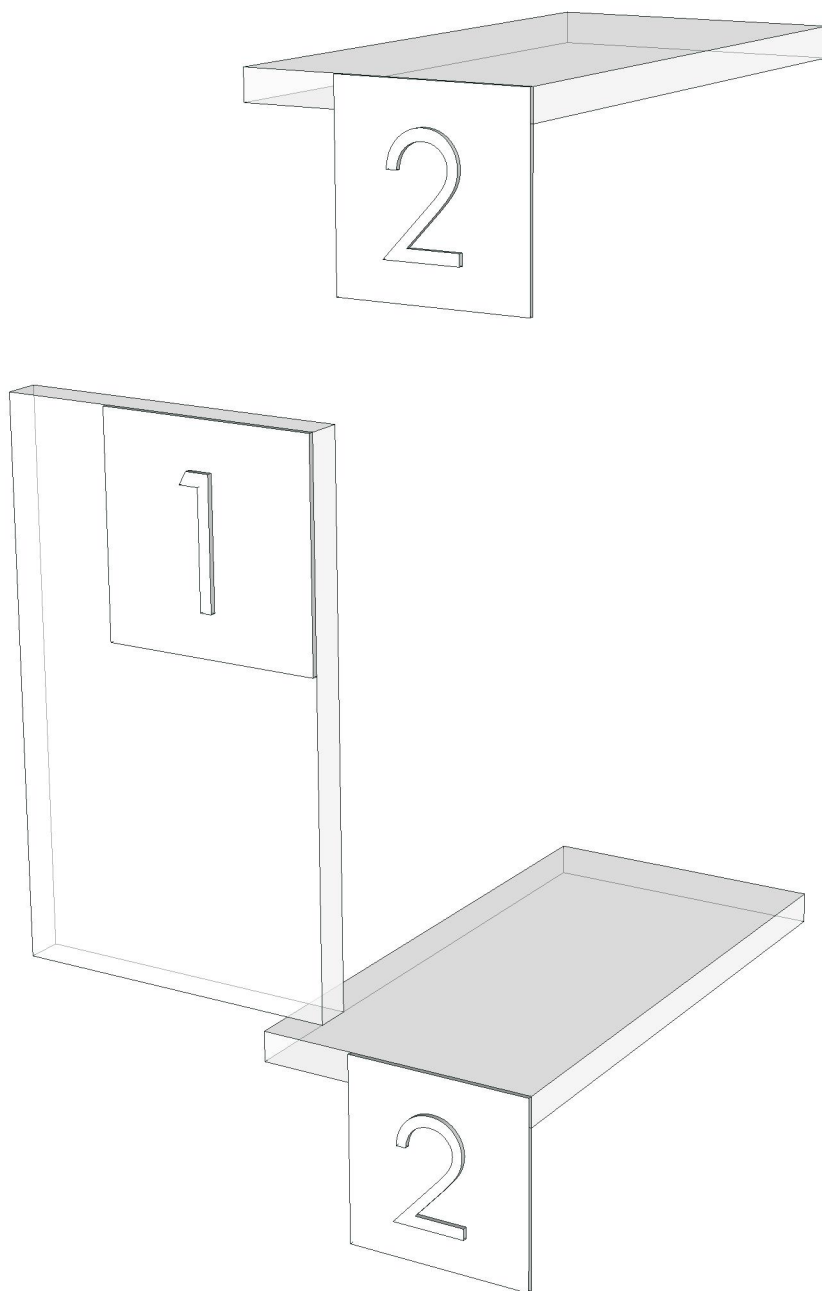

<b>Model</b>	PLUS_UD_DL220L_BT		
<b>Creator</b>	CHALEAMPHON	<b>.BCP Name</b>	INDEX_C3D_KITCHEN2
<b>Reviewer</b>		<b>Order</b>	H002237
<b>Approves</b>		<b>Date</b>	20/01/2026

## **PLUS\_UD\_DL220L\_BT-2200X300X650**

### **Colour**

05.74=ML.LIGHT TAUPE BT9 (PEARL)  
20.14=ML GRAPHITE # MK3200 (PEARL)  
05.01=ML WHITE VM1012 18/18

### **Edge**

01.393=1 BT9  
01.206=1 GRAPHITE MD204



K40L-160175286

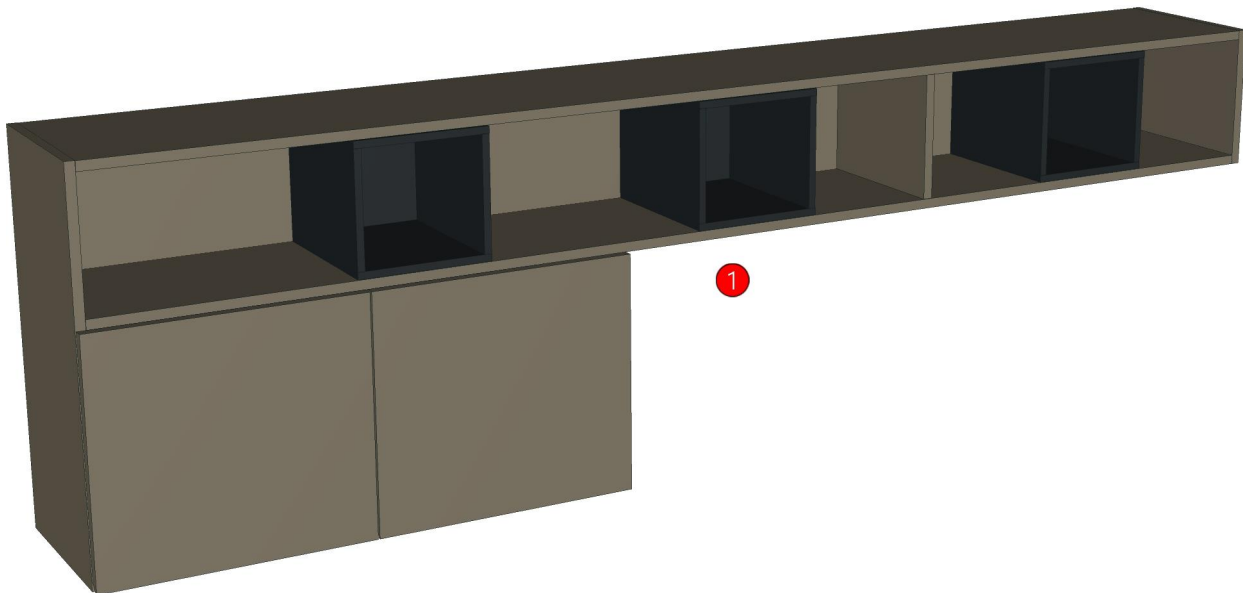

<b>Model</b>	-		
<b>Creator</b>	CHALEAMPHON	<b>.BCP Name</b>	INDEX_C3D_KITCHEN2
<b>Reviewer</b>		<b>Order</b>	H002237
<b>Approves</b>		<b>Date</b>	20/01/2026

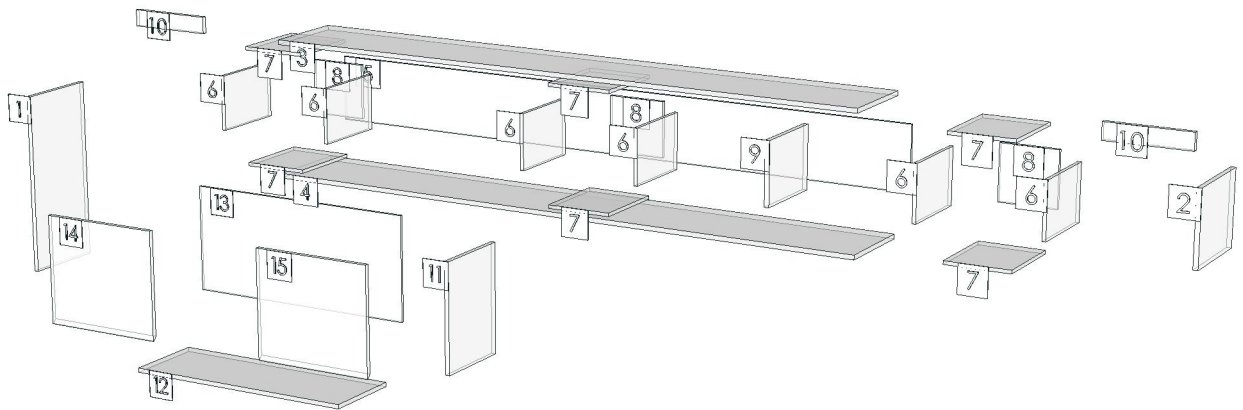

<b>Model</b>	PLUS_UD_DL60(H)AR		
<b>Creator</b>	CHALEAMPHON	<b>.BCP Name</b>	INDEX_C3D_KITCHEN2
<b>Reviewer</b>		<b>Order</b>	H002075
<b>Approves</b>		<b>Date</b>	23/10/2025

## **PLUS\_UD\_DL60(H)AR-600X300X355**

### **Colour**

05.111=ML.INDIAN ELIM MD762 (EVELYN)

20.40=ML MK630 (PEARL)

### **Edge**

01.407=1 AR8



- K10R-160171040
- K20R-160171050
- K20L-160175238
- K100L-160175192
- K100R-160175203
- K1000L-160175227
- K40L-160175286
- K200L-160177857



<b>Model</b>	-		
<b>Creator</b>	CHALEAMPHON	<b>.BCP Name</b>	INDEX_C3D_KITCHEN2
<b>Reviewer</b>		<b>Order</b>	H002075
<b>Approves</b>		<b>Date</b>	23/10/2025

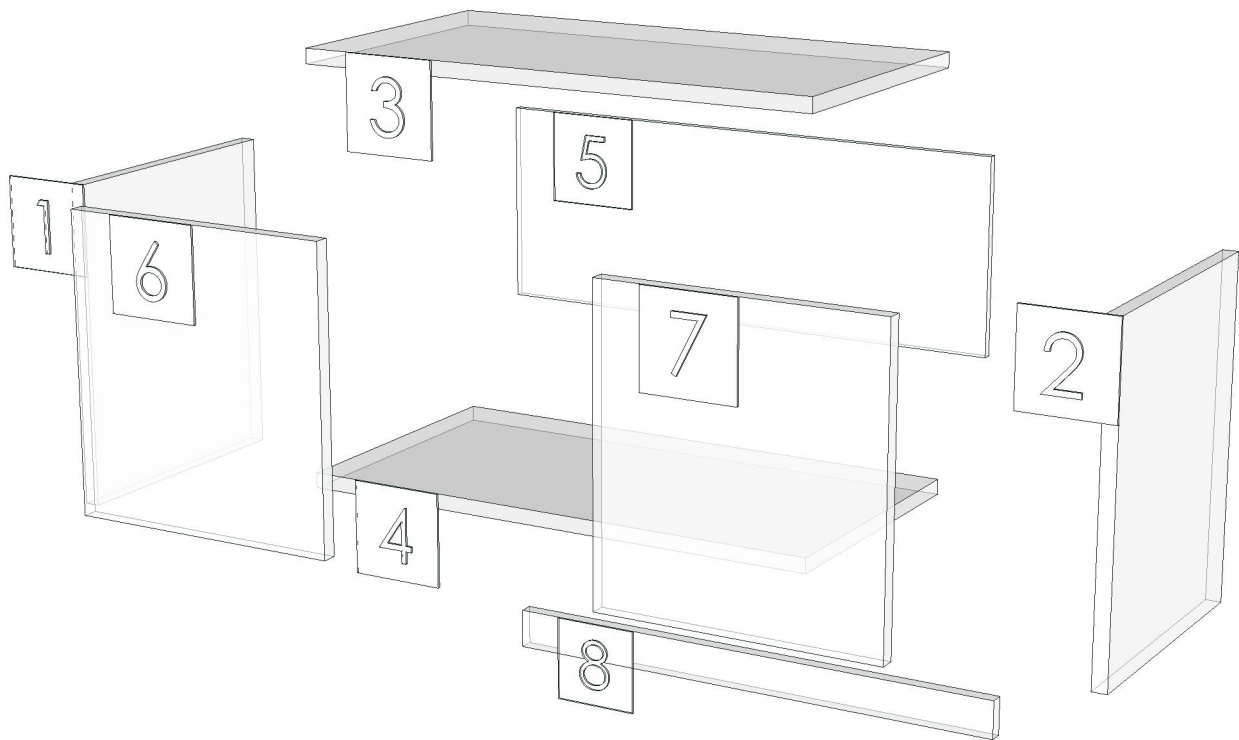

<b>Model</b>	PLUS_UD_DPLT_600		
<b>Creator</b>	CHALEAMPON	<b>.BCP Name</b>	INDEX_C3D_KITCHEN2
<b>Reviewer</b>		<b>Order</b>	H001012
<b>Approves</b>		<b>Date</b>	28/06/2024

## **PLUS\_UD\_DPLT\_600-600X9X100**

**Colour**

05.85=ML.SWISS ELM CHAMPAGNE#AR8 SYNCHRONOUS

**Edge**

01.407=1 AR8



- K2R-160171027
- K10R-160171040
- K20R-160171050
- K70L-160171061
- K2L-160175179
- K20L-160175238
- K100L-160175192
- K100R-160175203
- K101R-160175214
- K1000L-160175227
- K40L-160175286
- K200L-160177857

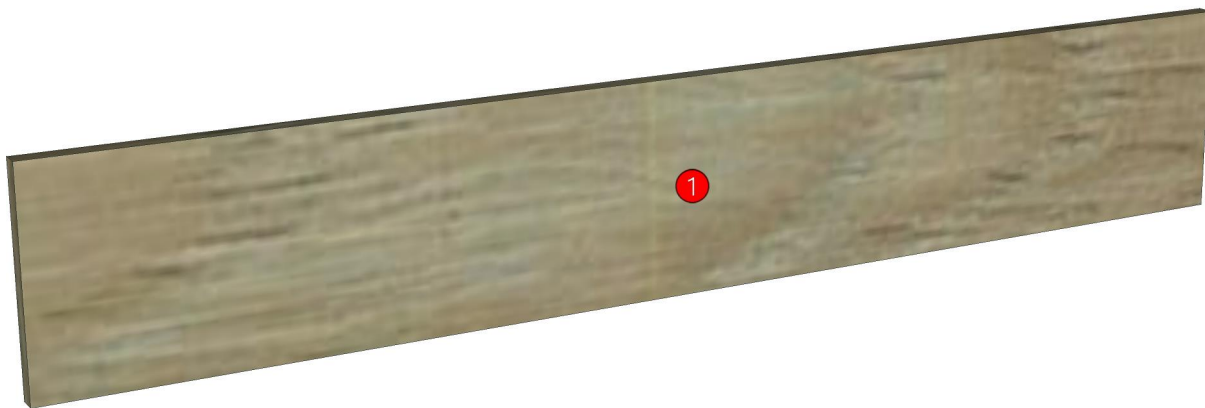

<b>Model</b>	PLUS_UD_DPLT_600		
<b>Creator</b>	CHALEAMPHON	<b>.BCP Name</b>	INDEX_C3D_KITCHEN2
<b>Reviewer</b>		<b>Order</b>	H001012
<b>Approves</b>		<b>Date</b>	28/06/2024

No.	Article No.	Description	Mat	Dimension	Cutting Size	Typepology	Skin
0	PLUS_UD_DPLT_600			600x100x9			
	PLUS_UD_DPLT_600-01	LEG	PB-ST	9x100x600	9X98X599;L2:W1	183000_STR=05.85_EDG=AR8-1	2

<b>Model</b>	PLUS_UD_DPLT-1600		
<b>Creator</b>	CHALEAMPON	<b>.BCP Name</b>	INDEX_C3D_KITCHEN2
<b>Reviewer</b>		<b>Order</b>	H002238
<b>Approves</b>		<b>Date</b>	20/01/2026

## PLUS\_UD\_DPLT-1600-1600X9X100

**Colour**

05.85=ML.SWISS ELM CHAMPAGNE#AR8 SYNCHRONOUS

**Edge**

01.407=1 AR8



K40L-160175286

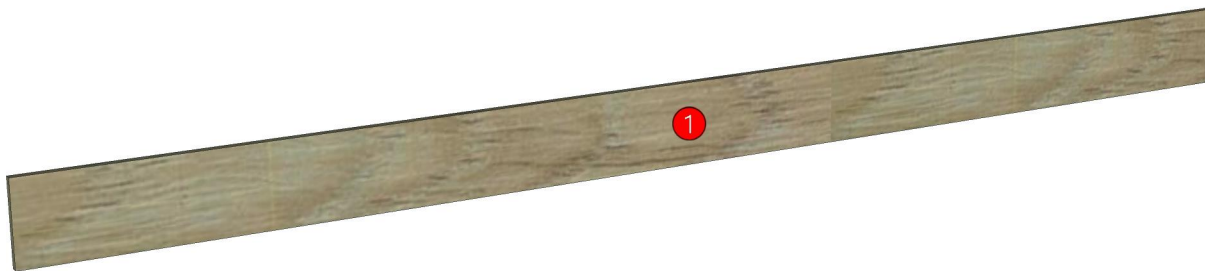

<b>Model</b>	PLUS_UD_DPLT-1600		
<b>Creator</b>	CHALEAMPON	<b>.BCP Name</b>	INDEX_C3D_KITCHEN2
<b>Reviewer</b>		<b>Order</b>	H002238
<b>Approves</b>		<b>Date</b>	20/01/2026

No.	Article No.	Description	Mat	Dimension	Cutting Size	Typepology	Skin
0	PLUS_UD_DPLT-1600			1600x100x9			
	PLUS_UD_DPLT-1600-02	LEG	PB-ST	9x100x1600	9X99X1599;L1:W1	183000_STR=05.85_EDG=AR8-1	2