

Model	PLUS_UD_DBH602		
Creator	CHALEAMPHON	.BCP Name	INDEX_C3D_KITCHEN2
Reviewer		Order	H000986
Approves		Date	20/06/2024

PLUS_UD_DBH602-600X570X738

Colour

05.111=ML.INDIAN ELIM MD762 (EVELYN)

Edge

01.407=1 AR8



- K2R-160171027
- K10R-160171040
- K20R-160171050
- K2L-160175179
- K20L-160175238
- K100L-160175192
- K100R-160175203
- K101R-160175214
- K1000L-160175227
- K40L-160175286
- K200L-160177857



Model	-PLUS_UD		
Creator	CHALEAMPHON	.BCP Name	INDEX_C3D_KITCHEN2
Reviewer		Order	H000986
Approves		Date	20/06/2024

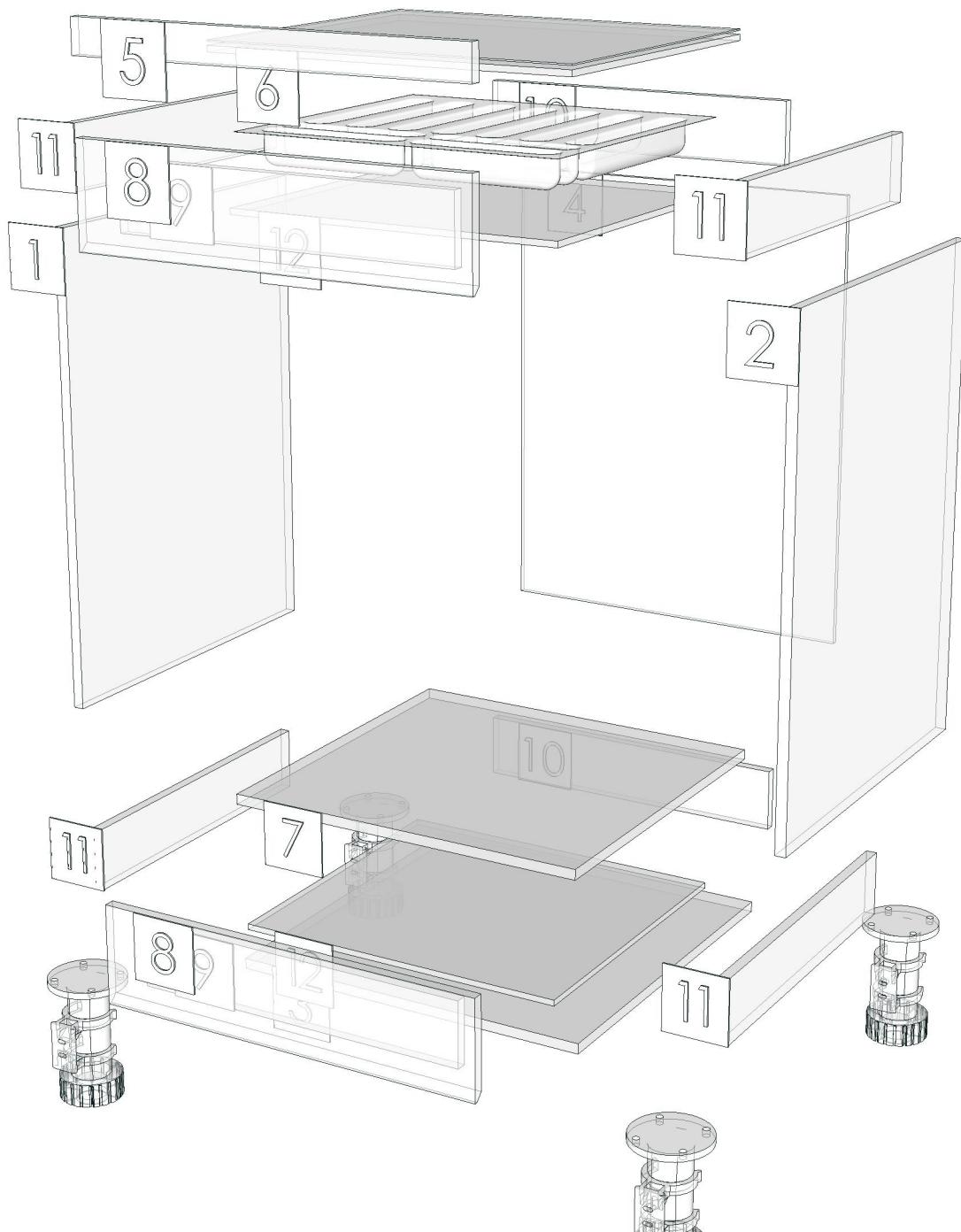

Model	PLUS_UD_DBO35_1		
Creator	CHALEAMPON	.BCP Name	INDEX_C3D_KITCHEN2
Reviewer		Order	H000987
Approves		Date	20/06/2024

PLUS_UD_DBO35_1-350X570X738

Colour

20.14=ML GRAPHITE # MK3200 (PEARL)

Edge

01.206=1 GRAPHITE MD204



K20R-160171050
K20L-160175238
K1000L-160175227
K40L-160175286

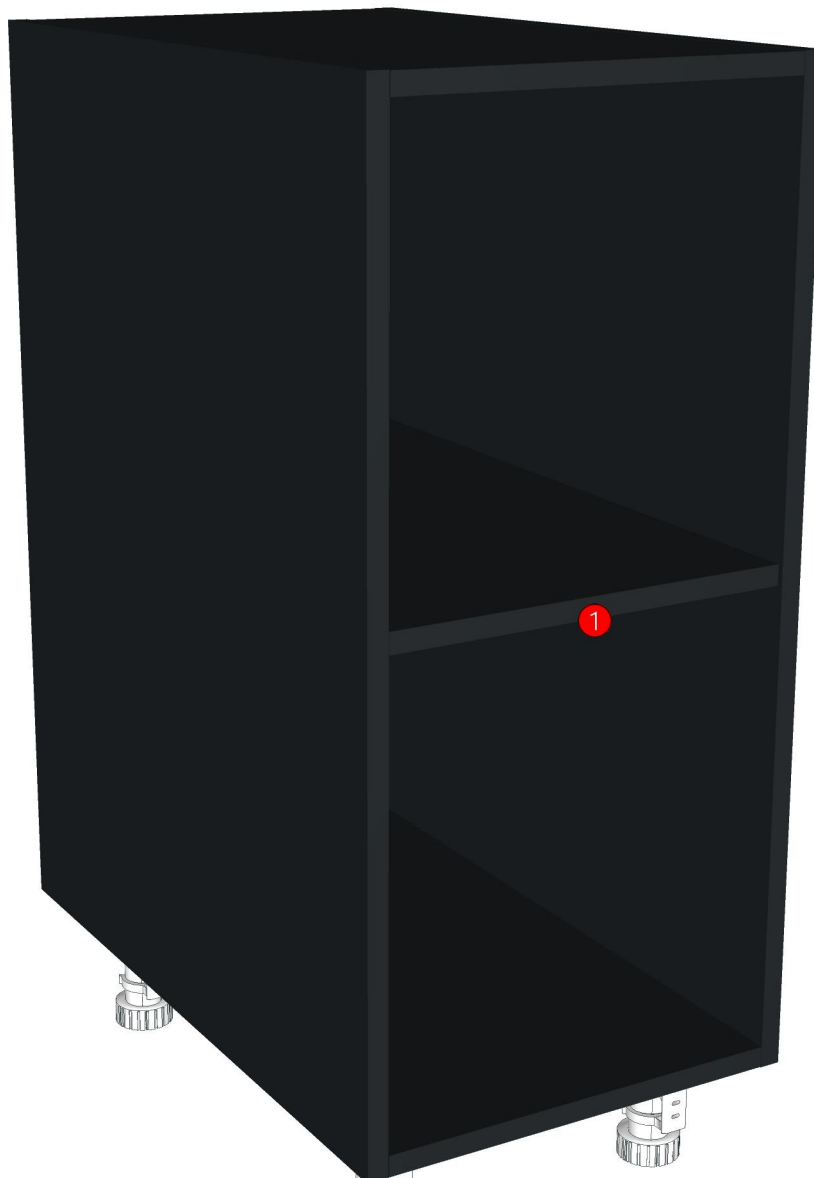

Model	-PLUS_UD		
Creator	CHALEAMPHON	.BCP Name	INDEX_C3D_KITCHEN2
Reviewer		Order	H000987
Approves		Date	20/06/2024

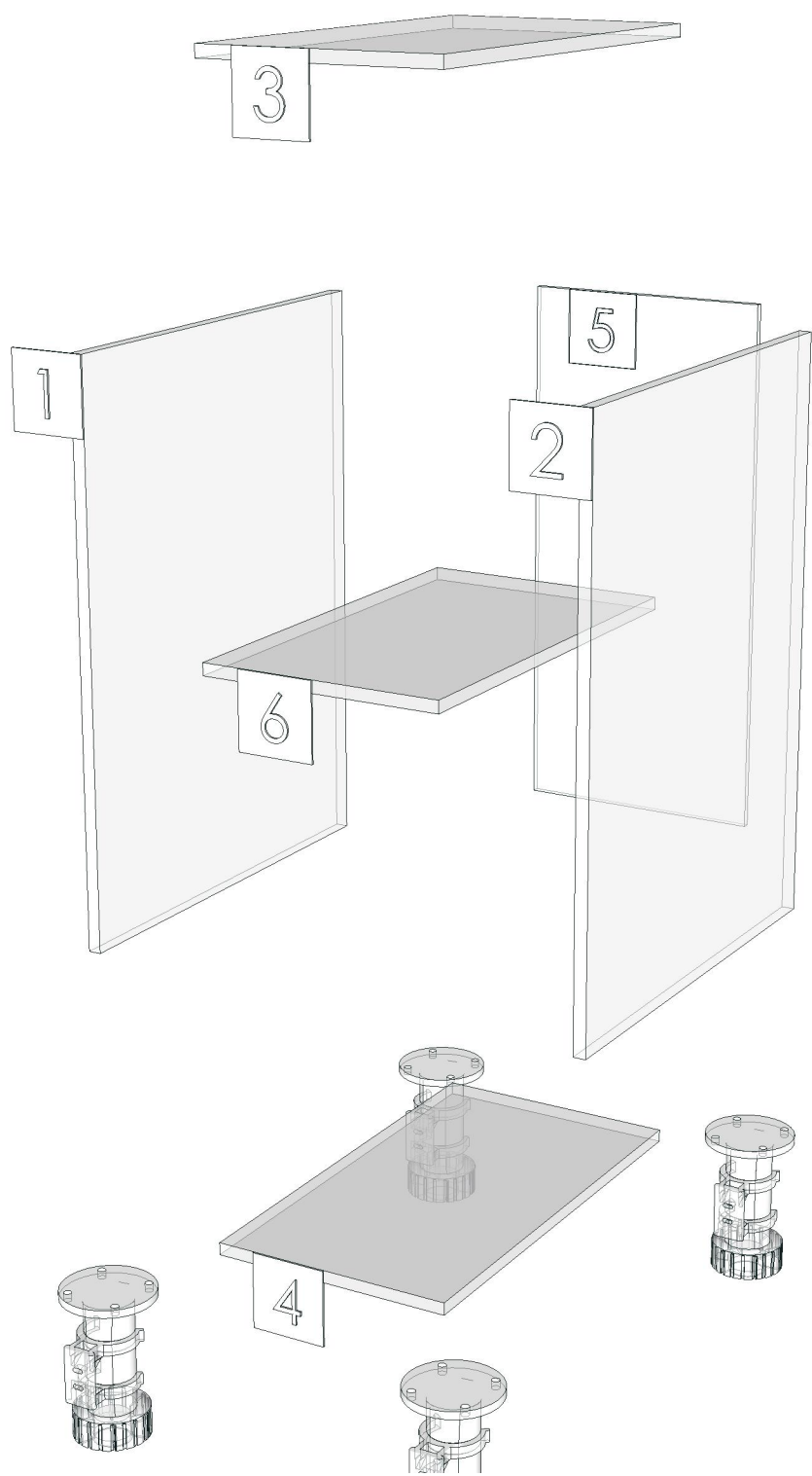

Model	PLUS_UD_DBOX_150		
Creator	CHALEAMPON	.BCP Name	INDEX_C3D_KITCHEN2
Reviewer		Order	H000988
Approves		Date	20/06/2024

PLUS_UD_DBOX_150-150X200X2100

Colour
05.74=ML.LIGHT TAUPE BT9 (PEARL)

Edge
01.393=1 BT9

R&D REVIEW	
<input checked="" type="checkbox"/>	DWG.Customer
<input checked="" type="checkbox"/>	Work Report
<input type="checkbox"/>	Function
<input type="checkbox"/>	สินค้าตรงตัวอย่าง
ผู้ทบทวน <u>P.SAWAI</u>	
<u>22/6/24</u>	

K20R-160171050
K20L-160175238



Model	-PLUS_UD		
Creator	CHALEAMPON	.BCP Name	INDEX_C3D_KITCHEN2
Reviewer		Order	H000988
Approves		Date	20/06/2024

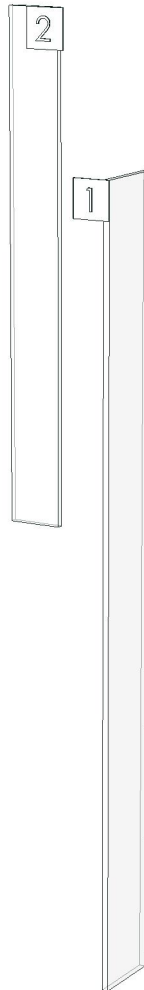

Model	PLUS_UD_DBS55		
Creator	CHALEAMPHON	.BCP Name	INDEX_C3D_KITCHEN2
Reviewer		Order	H000989
Approves		Date	20/06/2024

PLUS_UD_DBS55-550X570X738

Colour

05.111=ML.INDIAN ELIM MD762 (EVELYN)

Edge

01.407=1 AR8



- K10R-160171040
- K20R-160171050
- K20L-160175238
- K100L-160175192
- K100R-160175203
- K1000L-160157227
- K40L-160175286
- K200L-160177857



Model	-PLUS_UD		
Creator	CHALEAMPHON	.BCP Name	INDEX_C3D_KITCHEN2
Reviewer		Order	H000989
Approves		Date	20/06/2024

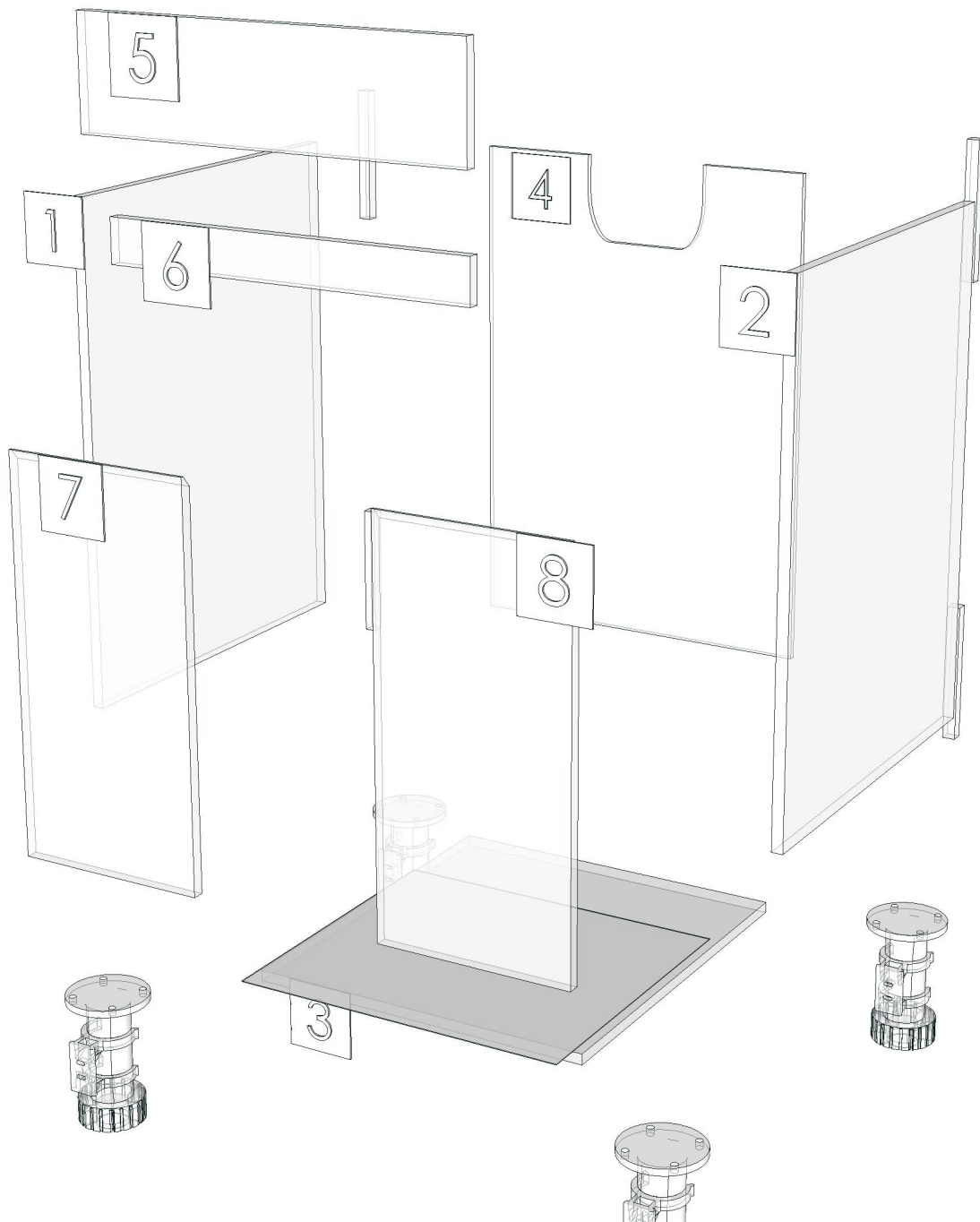

Model	PLUS_UD_DL205L_BT		
Creator	CHALEAMPHON	.BCP Name	INDEX_C3D_KITCHEN2
Reviewer		Order	H002213
Approves		Date	08/01/2026

PLUS_UD_DL205L_BT-2050X300X650

Colour

05.74=ML.LIGHT TAUPE BT9 (PEARL)
20.14=ML GRAPHITE # MK3200 (PEARL)
05.01=ML WHITE VM1012 18/18

Edge

01.393=1 BT9
01.206=1 GRAPHITE MD204



K20L-160175238
K1000L-160175227

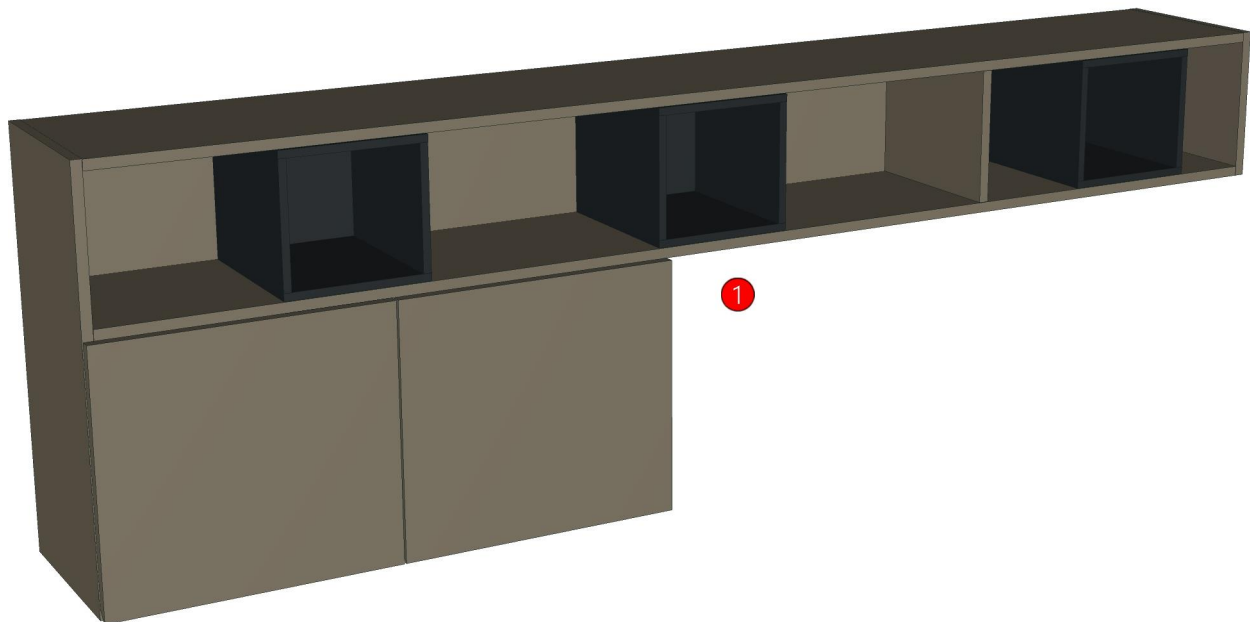

Model	-		
Creator	CHALEAMPHON	.BCP Name	INDEX_C3D_KITCHEN2
Reviewer		Order	H002213
Approves		Date	08/01/2026

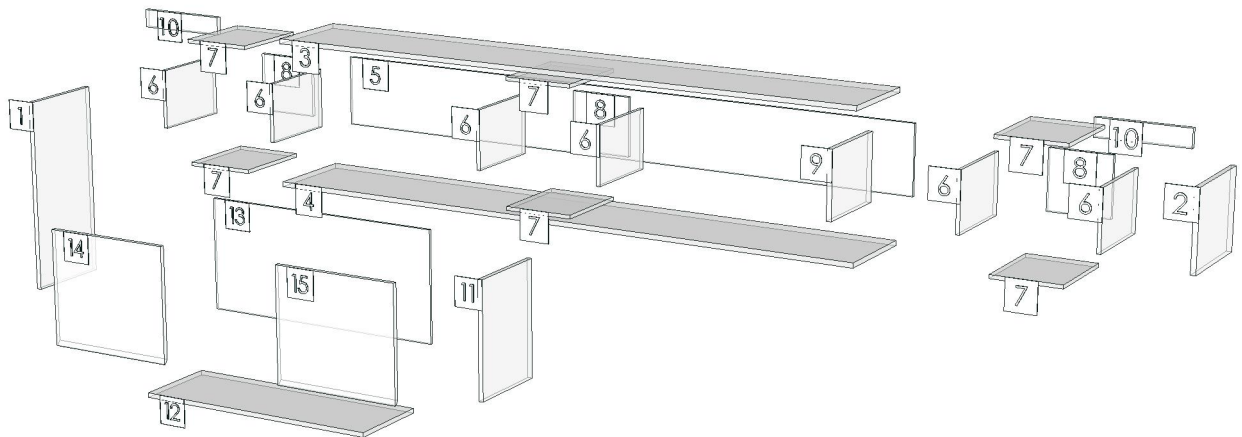

Model	PLUS_UD_DL60(H)AR		
Creator	CHALEAMPHON	.BCP Name	INDEX_C3D_KITCHEN2
Reviewer		Order	H002075
Approves		Date	23/10/2025

PLUS_UD_DL60(H)AR-600X300X355

Colour

05.111=ML.INDIAN ELIM MD762 (EVELYN)
20.40=ML MK630 (PEARL)

Edge

01.407=1 AR8



K10R-160171040
K20R-160171050
K20L-160175238
K100L-160175192
K100R-160175203
K1000L-160175227
K40L-160175286
K200L-160177857



Model	-		
Creator	CHALEAMPON	.BCP Name	INDEX_C3D_KITCHEN2
Reviewer		Order	H002075
Approves		Date	23/10/2025

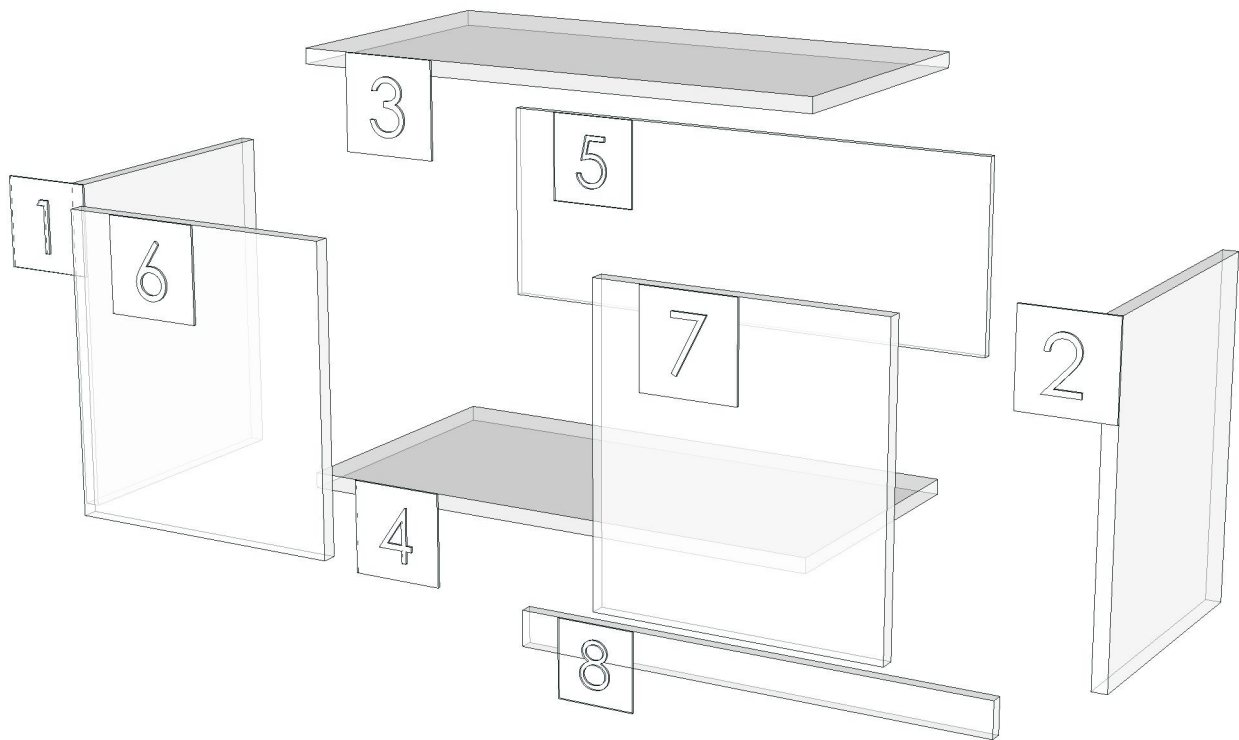

Model	PLUS_UD_DPLT-1500		
Creator	CHALEAMPON	.BCP Name	INDEX_C3D_KITCHEN2
Reviewer		Order	H001011
Approves		Date	28/06/2024

PLUS_UD_DPLT-1500-1500X9X100

Colour

05.85=ML.SWISS ELM CHAMPAGNE#AR8 SYNCHRONOUS

Edge

01.407=1 AR8



- K10R-160171040
- K20R-160171050
- K20L-160175238
- K100L-160175192
- K100R-160175203
- K1000L-160175227

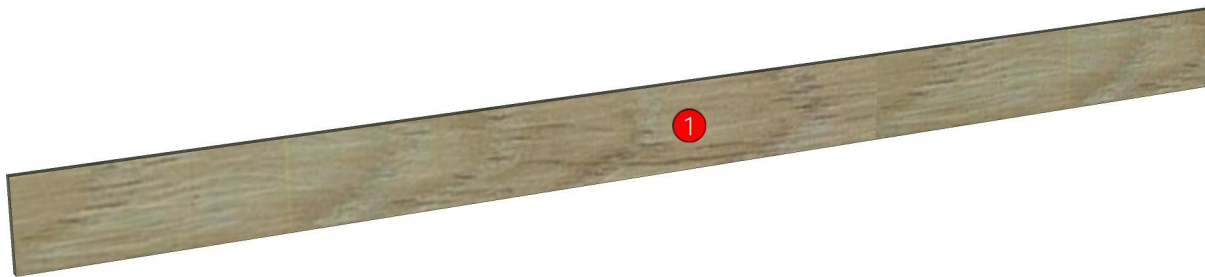

Model	PLUS_UD_DPLT-1500		
Creator	CHALEAMPHON	.BCP Name	INDEX_C3D_KITCHEN2
Reviewer		Order	H001011
Approves		Date	28/06/2024

No.	Article No.	Description	Mat	Dimension	Cutting Size	Typepology	Skin
0	PLUS_UD_DPLT-1500 PLUS_UD_DPLT-1500-01	LEG	PB-ST	1500x100x9 9x100x1500	9X98X1498;L2:W2	183000_STR=05.85_EDG=AR8-1	2

Model	PLUS_UD_DPLT_600		
Creator	CHALEAMPON	.BCP Name	INDEX_C3D_KITCHEN2
Reviewer		Order	H001012
Approves		Date	28/06/2024

PLUS_UD_DPLT_600-600X9X100

Colour

05.85=ML.SWISS ELM CHAMPAGNE#AR8 SYNCHRONOUS

Edge

01.407=1 AR8



- K2R-160171027
- K10R-160171040
- K20R-160171050
- K70L-160171061
- K2L-160175179
- K20L-160175238
- K100L-160175192
- K100R-160175203
- K101R-160175214
- K1000L-160175227
- K40L-160175286
- K200L-160177857



Model	PLUS_UD_DPLT_600		
Creator	CHALEAMPON	.BCP Name	INDEX_C3D_KITCHEN2
Reviewer		Order	H001012
Approves		Date	28/06/2024

No.	Article No.	Description	Mat	Dimension	Cutting Size	Typepology	Skin
0	PLUS_UD_DPLT_600			600x100x9			
	PLUS_UD_DPLT_600-01	LEG	PB-ST	9x100x600	9X98X599;L2:W1	183000_STR=05.85_EDG=AR8-1	2

Model	PLUS_UD_DSH300L		
Creator	CHALEAMPHON	.BCP Name	INDEX_C3D_KITCHEN2
Reviewer		Order	H002188
Approves		Date	15/12/2025

PLUS_UD_DSH300L-300X150X1016

Colour

05.111=ML.INDIAN ELIM MD762 (EVELYN)

20.14=ML GRAPHITE # MK3200 (PEARL)

Edge

01.407=1 AR8

01.206=1 GRAPHITE MD204

R&D REVIEW	
<input checked="" type="checkbox"/>	DWG.Customer
<input checked="" type="checkbox"/>	Work Report
<input type="checkbox"/>	Function
<input type="checkbox"/>	สินค้าตรงตัวอย่าง
ผู้ทบทวน <u>P.SAWAI</u>	
<u>22/12/25</u>	

K20L-160175238

K1000L-160175227



Model	-		
Creator	CHALEAMPHON	.BCP Name	INDEX_C3D_KITCHEN2
Reviewer		Order	H002188
Approves		Date	15/12/2025

