

<b>Model</b>	ESCENT_BNA_DB301LS		
<b>Creator</b>	SUTTHI.P	<b>.BCP Name</b>	INDEX_C3D_KITCHENPAE
<b>Reviewer</b>		<b>Order</b>	O003160
<b>Approves</b>		<b>Date</b>	23/04/2026

## **ESCENT\_BNA\_DB301LS-300X570X772**

**Colour**

05.01=ML WHITE VM1012 18/18

05.72=ML.MD645 LONG BEACH (SN)

**Edge**

01.24=0.6 WHITE

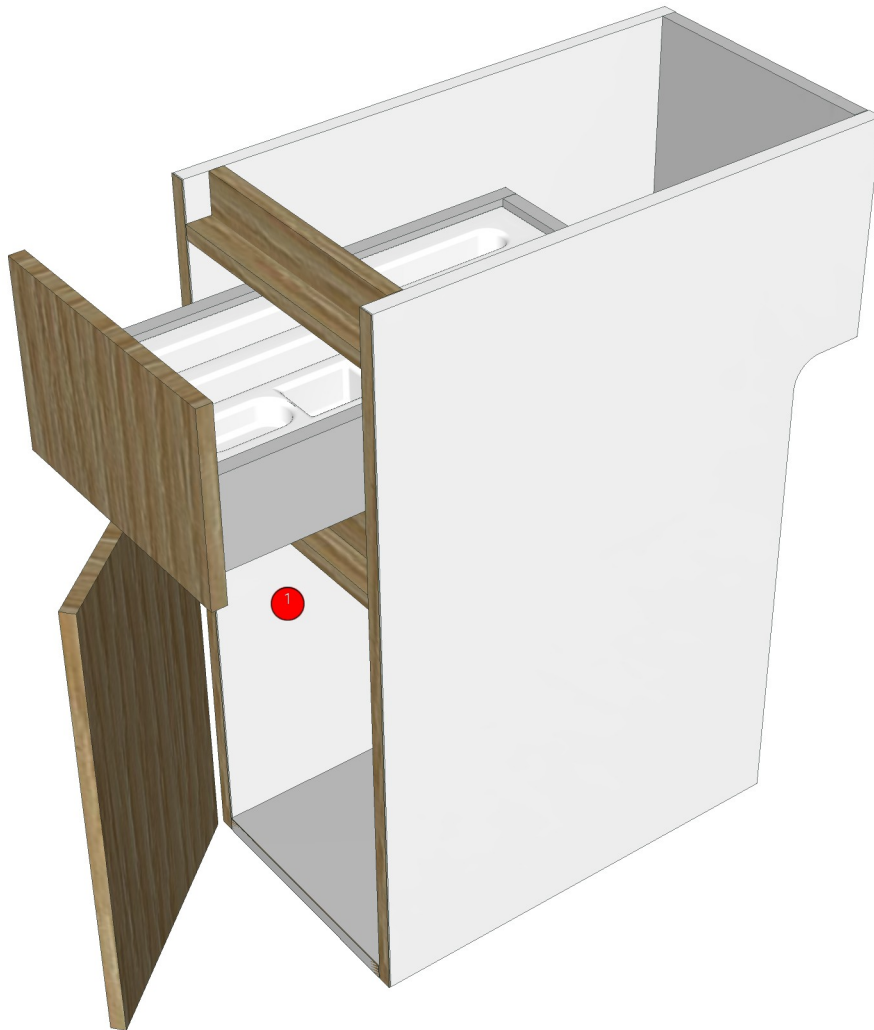

01.392=1 LONG BEACH-MD645 (MW40-A1059TH00)

K15R\_160178565

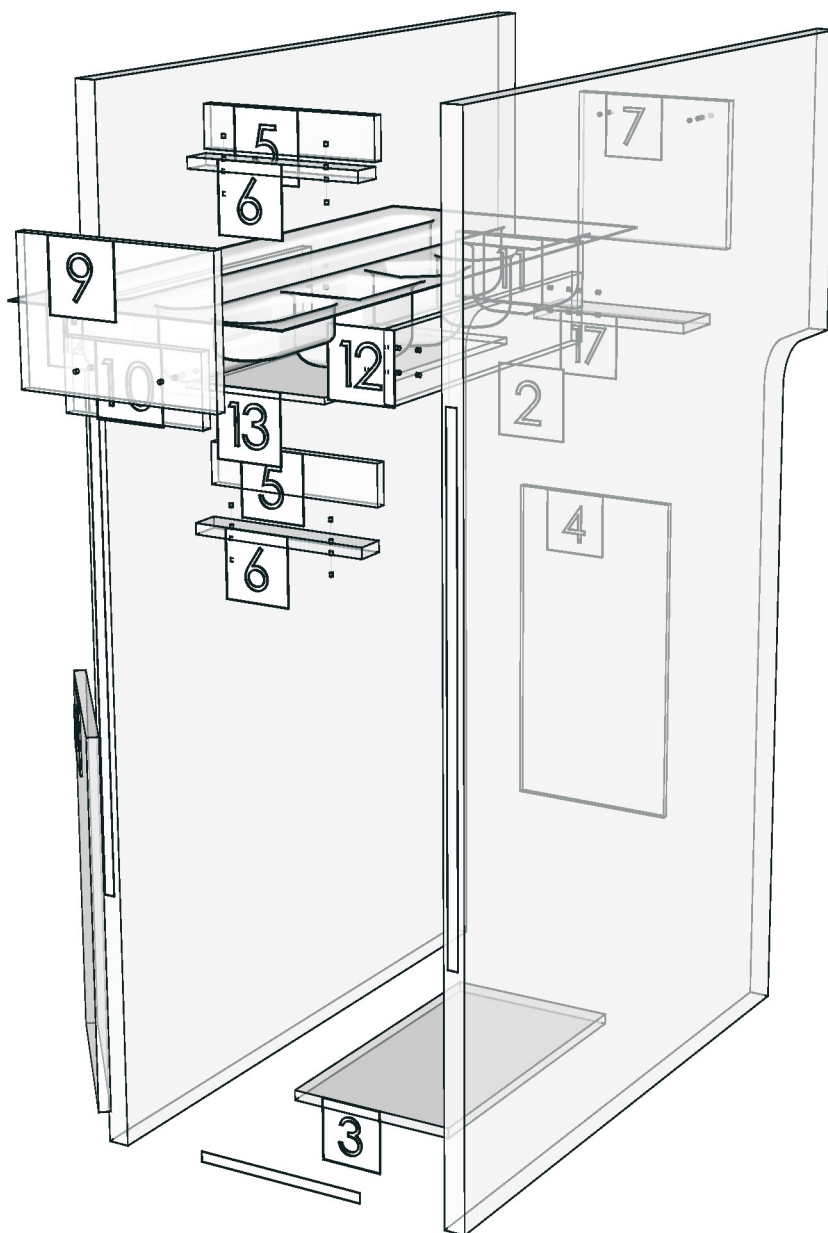

<b>Model</b>	-ESCENT_BNA_DB301LS		
<b>Creator</b>		<b>.BCP Name</b>	INDEX_C3D_KITCHENPAE
<b>Reviewer</b>		<b>Order</b>	I003160
<b>Approves</b>		<b>Date</b>	



<b>Model</b>	ESCENT_BNA_DBH601S_		
<b>Creator</b>	SUTTHI.P	<b>.BCP Name</b>	INDEX_C3D_KITCHENPAE
<b>Reviewer</b>	 	<b>Order</b>	O003161
<b>Approves</b>		<b>Date</b>	29/04/2026

## ESCENT\_BNA\_DBH601S\_-600X570X772

**Colour**

05.01=ML WHITE VM1012 18/18  
05.72=ML.MD645 LONG BEACH (SN)

**Edge**

01.24=0.6 WHITE  
01.392=1 LONG BEACH-MD645 (MW40-A1059TH00)

K15R\_160178565

**R&D REVIEW**

- DWG.Customer
- Work Report
- Function
- สินค้าตรงตัวอย่าง

ผู้ทบทวน 

29, 4, 69

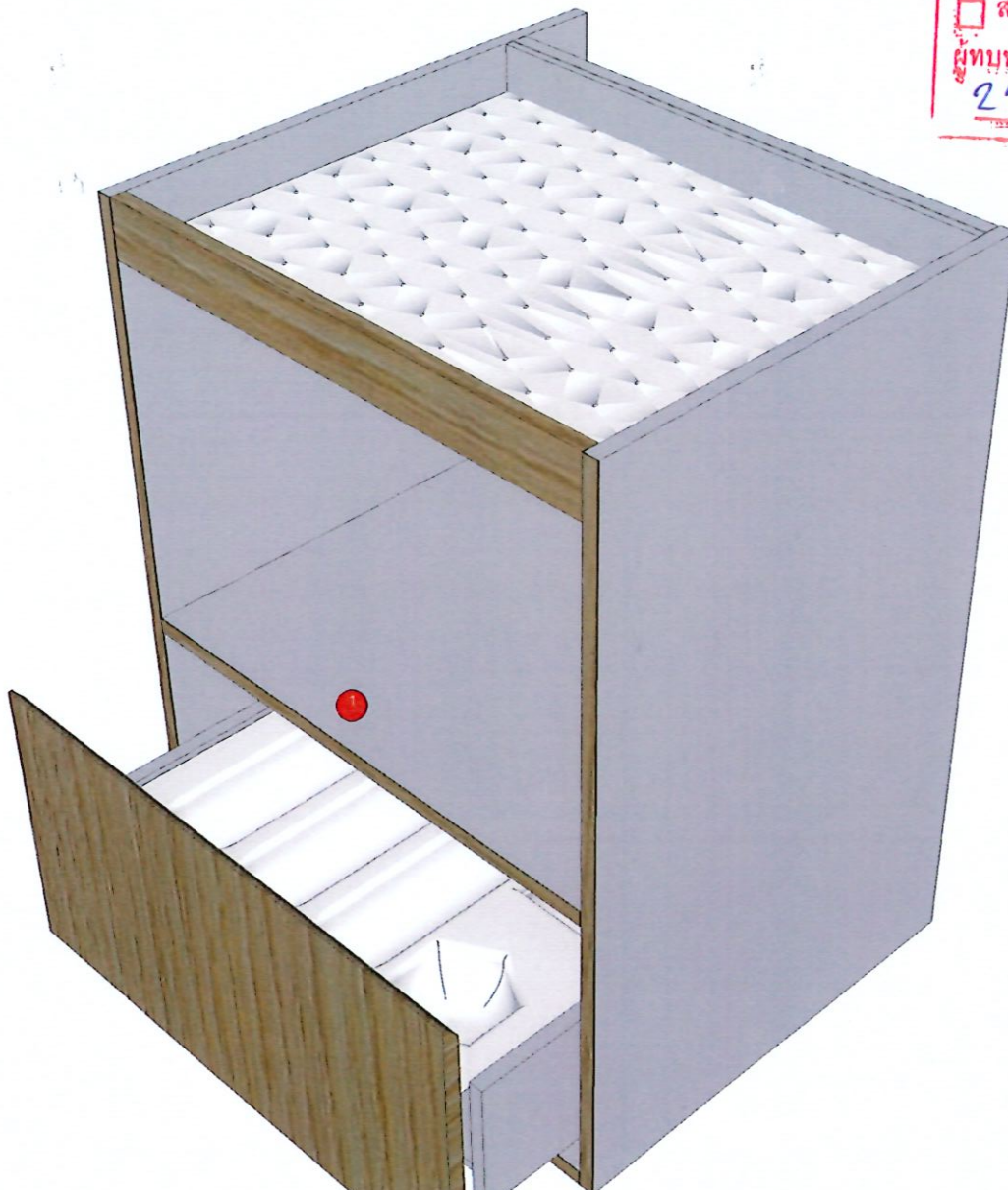

<b>Model</b>	-ESCENT_BNA_DBH601S_	<b>.BCP Name</b>	INDEX_C3D_KITCHENPAE
<b>Creator</b>		<b>Order</b>	I003161
<b>Reviewer</b>	<i>dr</i> <i>B</i>	<b>Date</b>	
<b>Approves</b>			

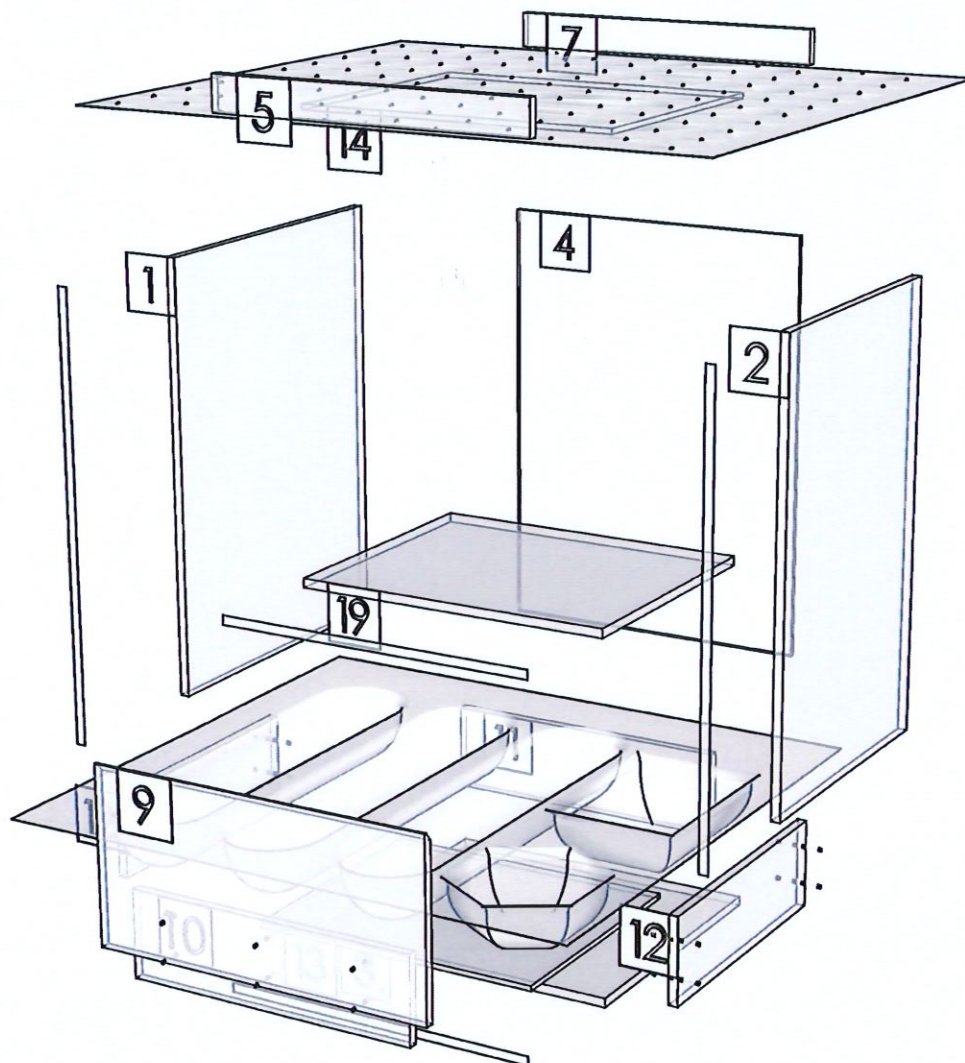

<b>Model</b>	ESCENT_BNA_DBS55R_		
<b>Creator</b>	SUTTHI.P	<b>.BCP Name</b>	INDEX_C3D_KITCHENPAE
<b>Reviewer</b>		<b>Order</b>	O003098
<b>Approves</b>		<b>Date</b>	01/04/2026

## ESCENT\_BNA\_DBS55R\_-550X570X772

**Colour**

05.01=ML WHITE VM1012 18/18  
05.72=ML.MD645 LONG BEACH (SN)

**Edge**

01.24=0.6 WHITE  
01.392=1 LONG BEACH-MD645 (MW40-A1059TH00)

K3R\_160177246

K15R\_160178565



**R&D REVIEW**

- DWG.Customer
- Work Report
- Function
- สินค้าตรงตัวอย่าง

ผู้ทบทวน 

7 / 5 / 69

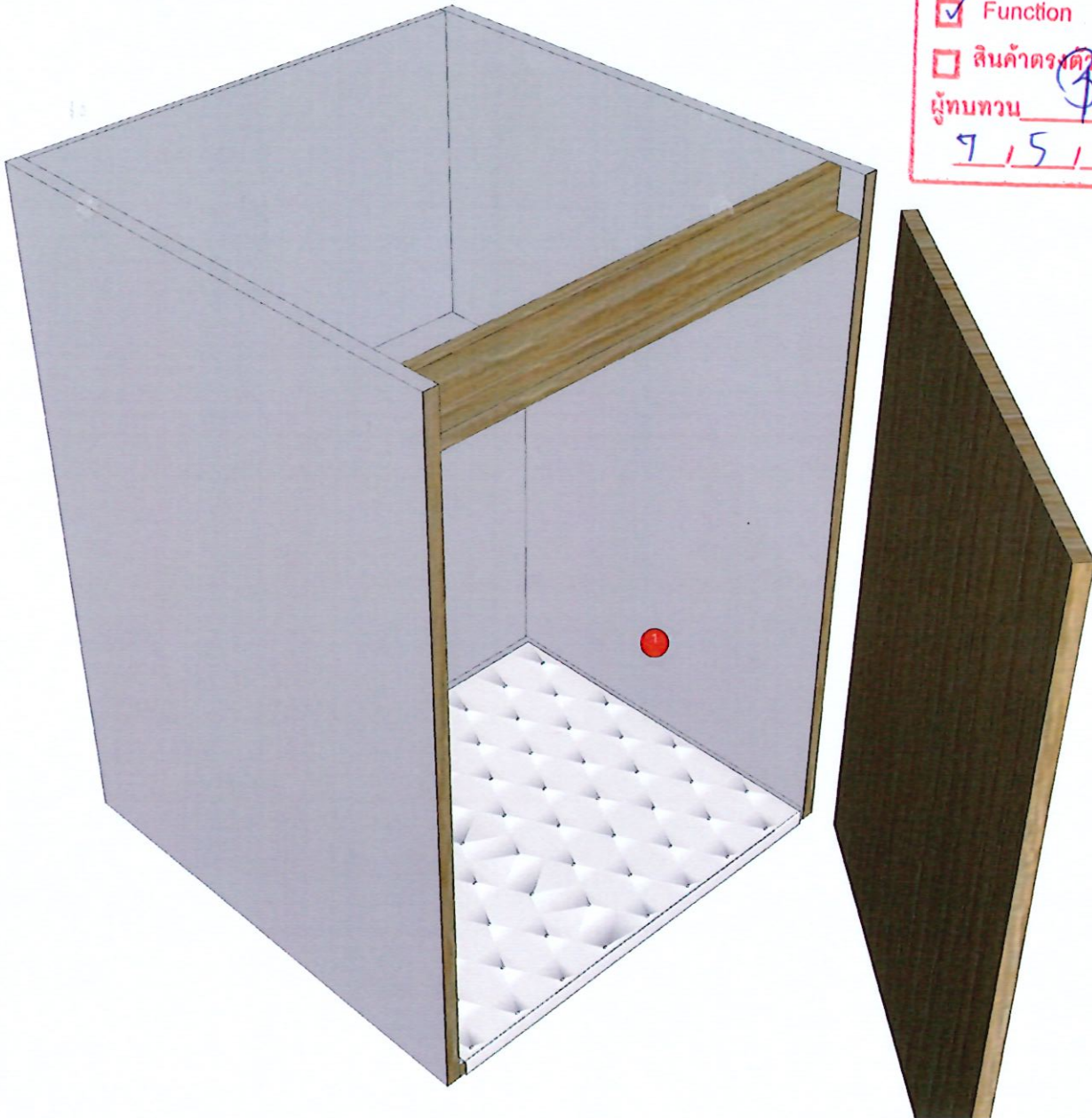

<b>Model</b>	-ESCENT_BNA_DBS55R_		
<b>Creator</b>		<b>.BCP Name</b>	INDEX_C3D_KITCHENPAE
<b>Reviewer</b>		<b>Order</b>	I003098
<b>Approves</b>		<b>Date</b>	

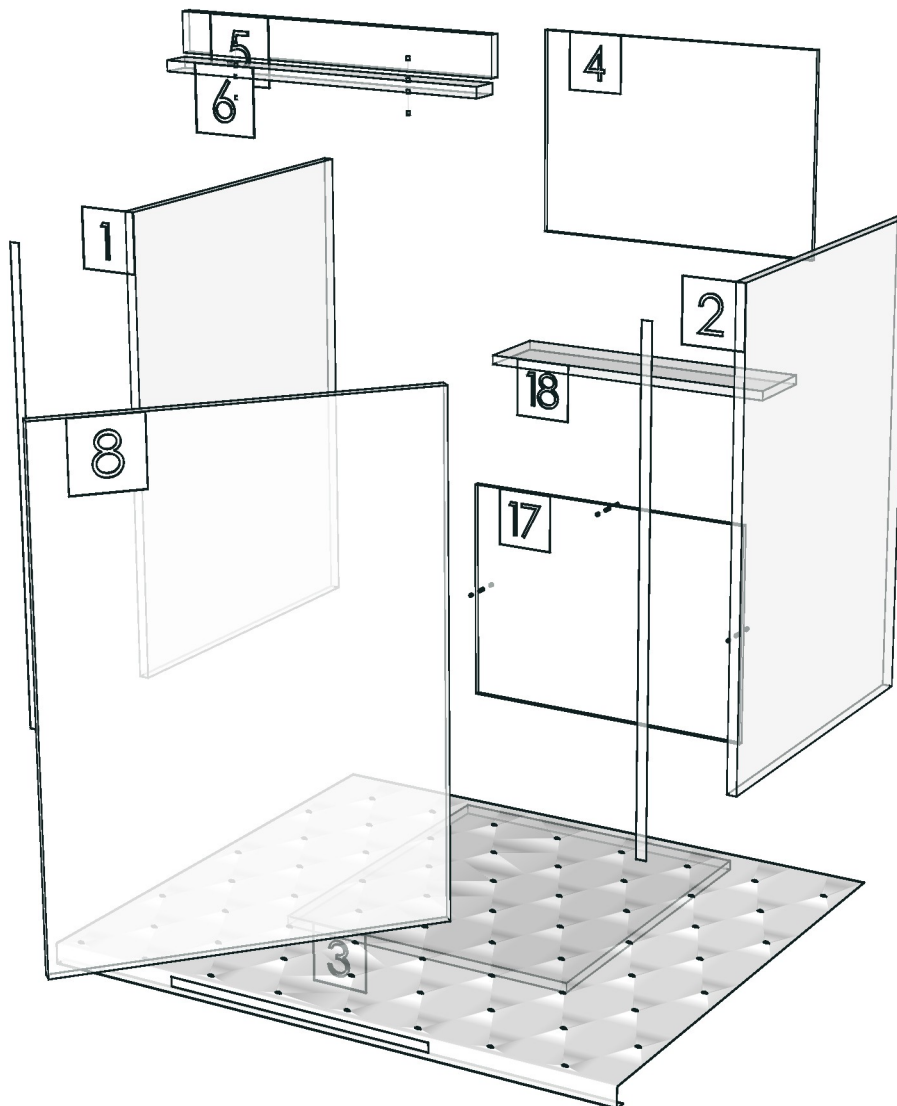

<b>Model</b>	ESCENT_BNA_DEPB_		
<b>Creator</b>	SUTTHI.P	<b>.BCP Name</b>	INDEX_C3D_KITCHENPAE
<b>Reviewer</b>		<b>Order</b>	O003074
<b>Approves</b>		<b>Date</b>	01/04/2026

## **ESCENT\_BNA\_DEPB\_-590X16X772**

### **Colour**

05.01=ML WHITE VM1012 18/18

05.72=ML.MD645 LONG BEACH (SN)

### **Edge**

01.24=0.6 WHITE

01.392=1 LONG BEACH-MD645 (MW40-A1059TH00)

K1R\_160175432

K2R\_160175441

K3L\_160175451

K1L\_160177227

K2L\_160177236

K3R\_160177246

K15R\_160178565

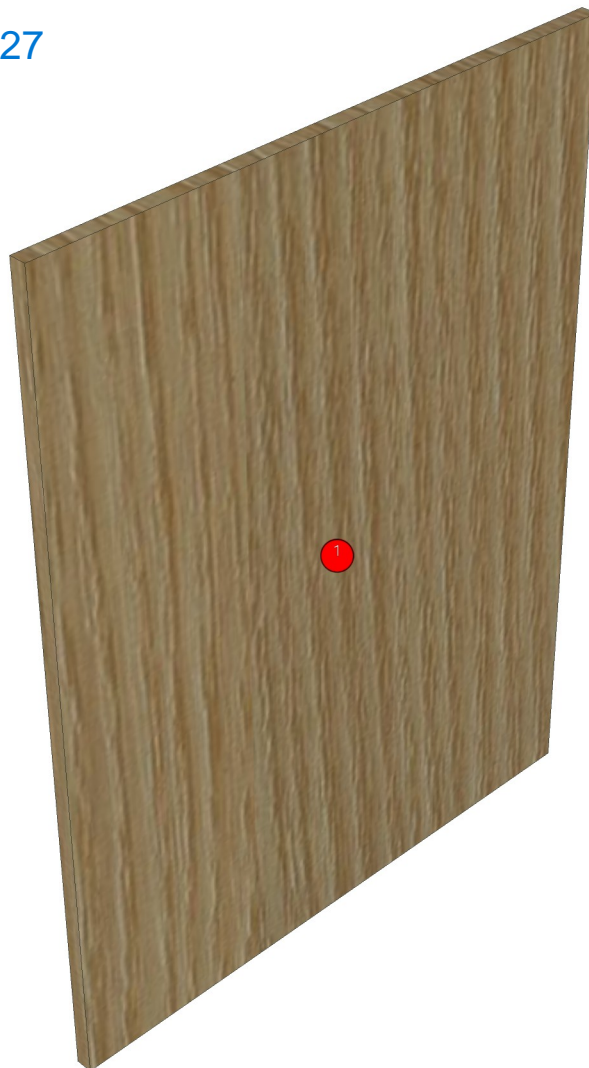

<b>Model</b>	-ESCENT_BNA_DEPB_		
<b>Creator</b>		<b>.BCP Name</b>	INDEX_C3D_KITCHENPAE
<b>Reviewer</b>		<b>Order</b>	I003074
<b>Approves</b>		<b>Date</b>	

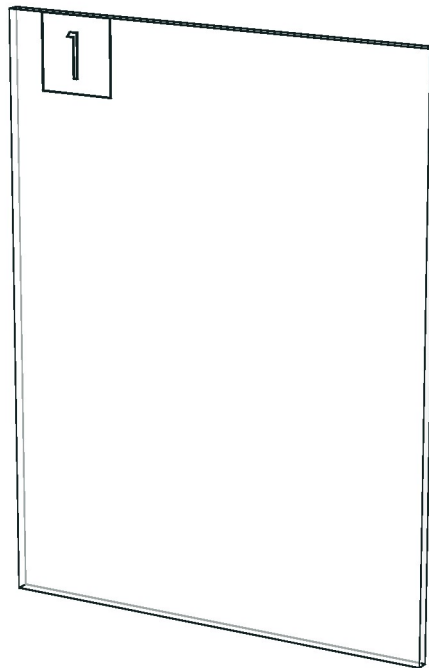

<b>Model</b>	ESCENT_BNA_DFB_		
<b>Creator</b>	SUTTHI.P	<b>.BCP Name</b>	INDEX_C3D_KITCHENPAE
<b>Reviewer</b>		<b>Order</b>	O003075
<b>Approves</b>		<b>Date</b>	01/04/2026

## **ESCENT\_BNA\_DFB\_-150X570X772**

### **Colour**

05.01=ML WHITE VM1012 18/18

05.72=ML.MD645 LONG BEACH (SN)

### **Edge**

01.24=0.6 WHITE

01.392=1 LONG BEACH-MD645 (MW40-A1059TH00)

K1R\_160175432

K2R\_160175441

K3L\_160175451

K1L\_160177227

K2L\_160177236

K3R160177246

K15R\_160178565

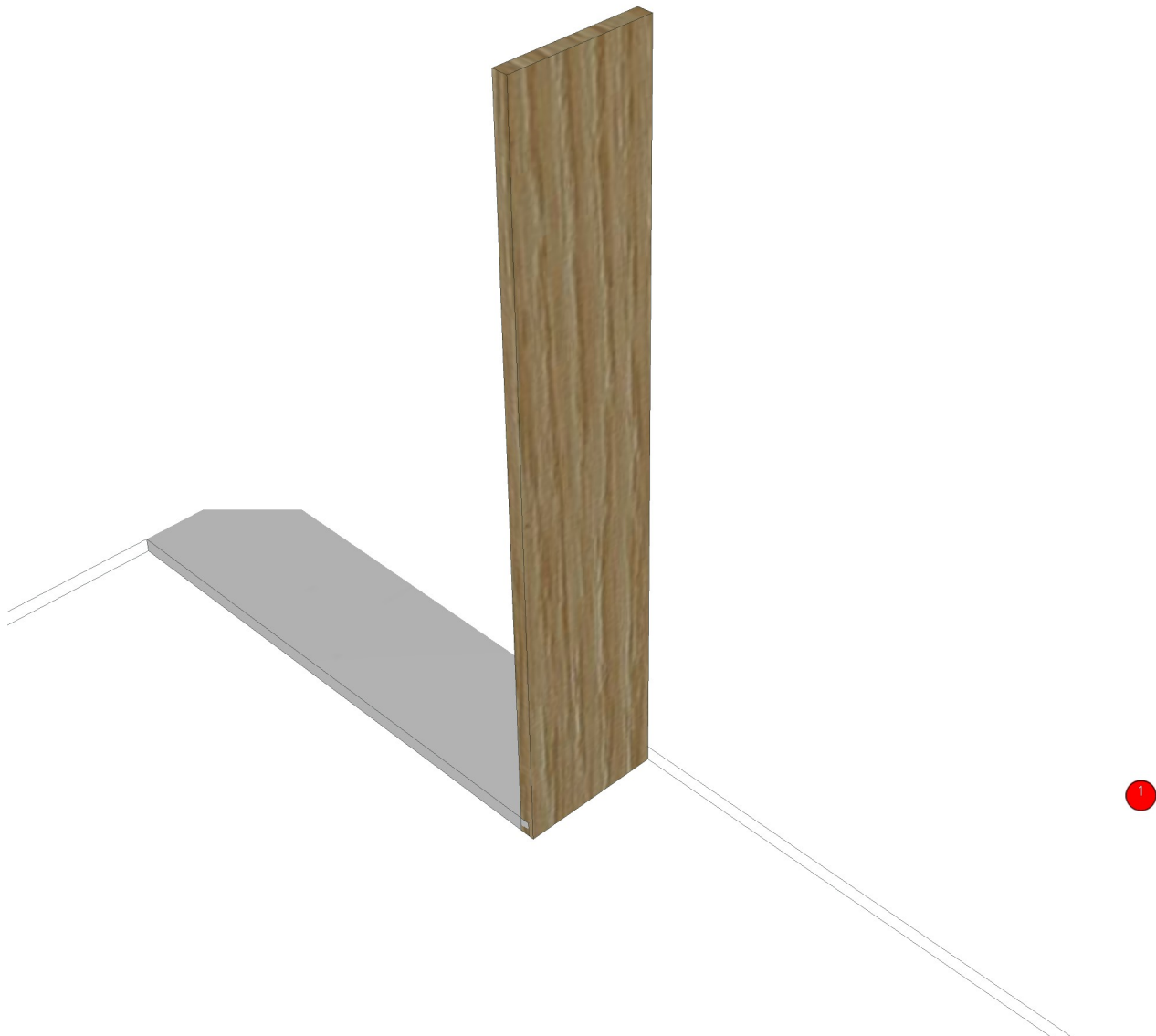

<b>Model</b>	-ESCENT_BNA_DFB_		
<b>Creator</b>		<b>.BCP Name</b>	INDEX_C3D_KITCHENPAE
<b>Reviewer</b>		<b>Order</b>	I003075
<b>Approves</b>		<b>Date</b>	

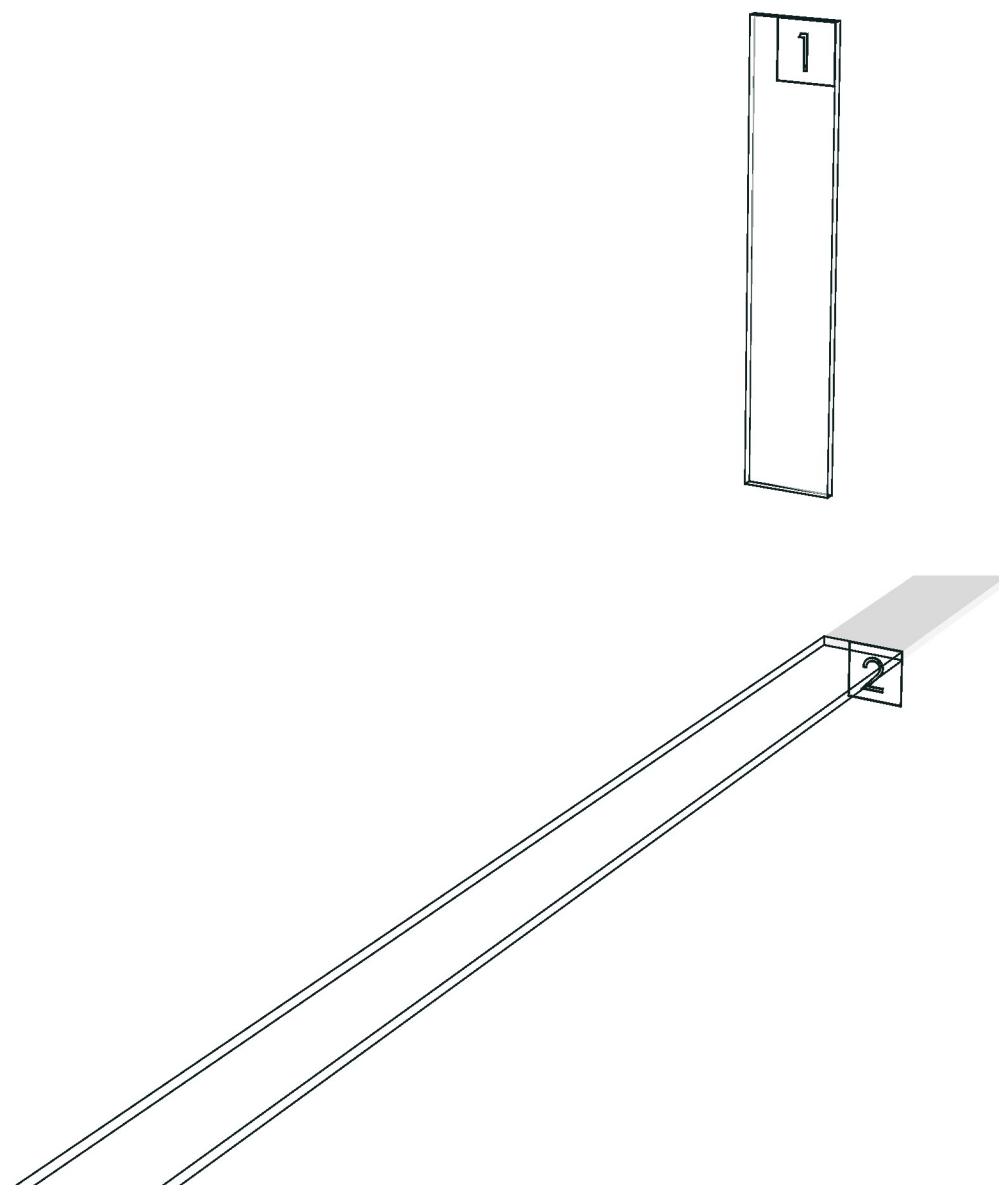

<b>Model</b>	ESCENT_BNA_DFCL_1550H		
<b>Creator</b>	SUTTHI.P	<b>.BCP Name</b>	INDEX_C3D_KITCHENPAE
<b>Reviewer</b>		<b>Order</b>	0003069
<b>Approves</b>	P.SAWA	<b>Date</b>	30/01/2026

## **ESCENT\_BNA\_DFCL\_1550H-1550X9X320**

**Colour**

05.01=ML WHITE VM1012 18/18  
05.72=ML.MD645 LONG BEACH (SN)

**Edge**

01.24=0.6 WHITE  
01.392=1 LONG BEACH-MD645 (MW40-A1059TH00)

**K3L 160175451**

**K3R 160177246**

<b>R&amp;D REVIEW</b>	
<input checked="" type="checkbox"/>	DWG.Customer
<input type="checkbox"/>	Work Report
<input type="checkbox"/>	Function
<input type="checkbox"/>	สินค้าตรงตัวอย่าง
ผู้ทบทวน <u>P.SAWA</u>	
<u>31</u> / <u>1</u> / <u>69</u>	

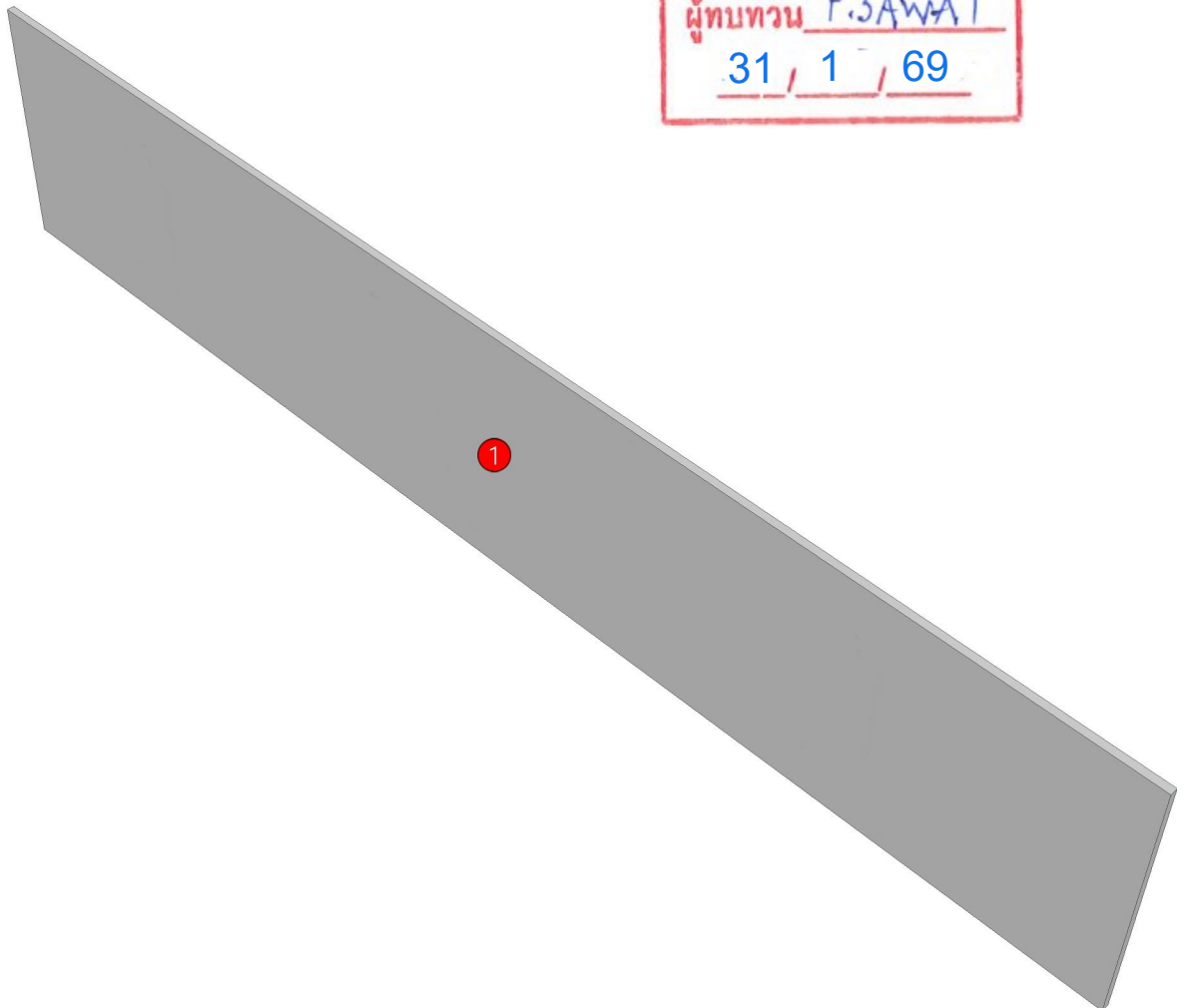

<b>Model</b>	-ESCENT_BNA_DFCL_1550H		
<b>Creator</b>	SUTTHI.P	<b>.BCP Name</b>	INDEX_C3D_KITCHENPAE
<b>Reviewer</b>		<b>Order</b>	0003069
<b>Approves</b>	P. SAWA	<b>Date</b>	30/01/2026

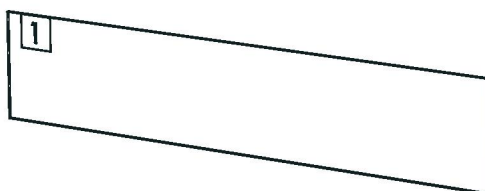

<b>Model</b>	ESCENT_BNA_DFCL_525H		
<b>Creator</b>	SUTTHI.P	<b>.BCP Name</b>	INDEX_C3D_KITCHENPAE
<b>Reviewer</b>		<b>Order</b>	O003070
<b>Approves</b>	P.SAWA	<b>Date</b>	30/01/2026

## **ESCENT\_BNA\_DFCL\_525H-525X9X320**

**Colour**

05.01=ML WHITE VM1012 18/18  
05.72=ML.MD645 LONG BEACH (SN)

**Edge**

01.24=0.6 WHITE  
01.392=1 LONG BEACH-MD645 (MW40-A1059TH00)

**K3L 160175451**

**K3R 160177246**

<b>R&amp;D REVIEW</b>	
<input checked="" type="checkbox"/>	DWG.Customer
<input type="checkbox"/>	Work Report
<input type="checkbox"/>	Function
<input type="checkbox"/>	สินค้าตรงตัวอย่าง
ผู้ทบทวน <u>P.SAWA</u>	
<u>31 / 1 / 69</u>	

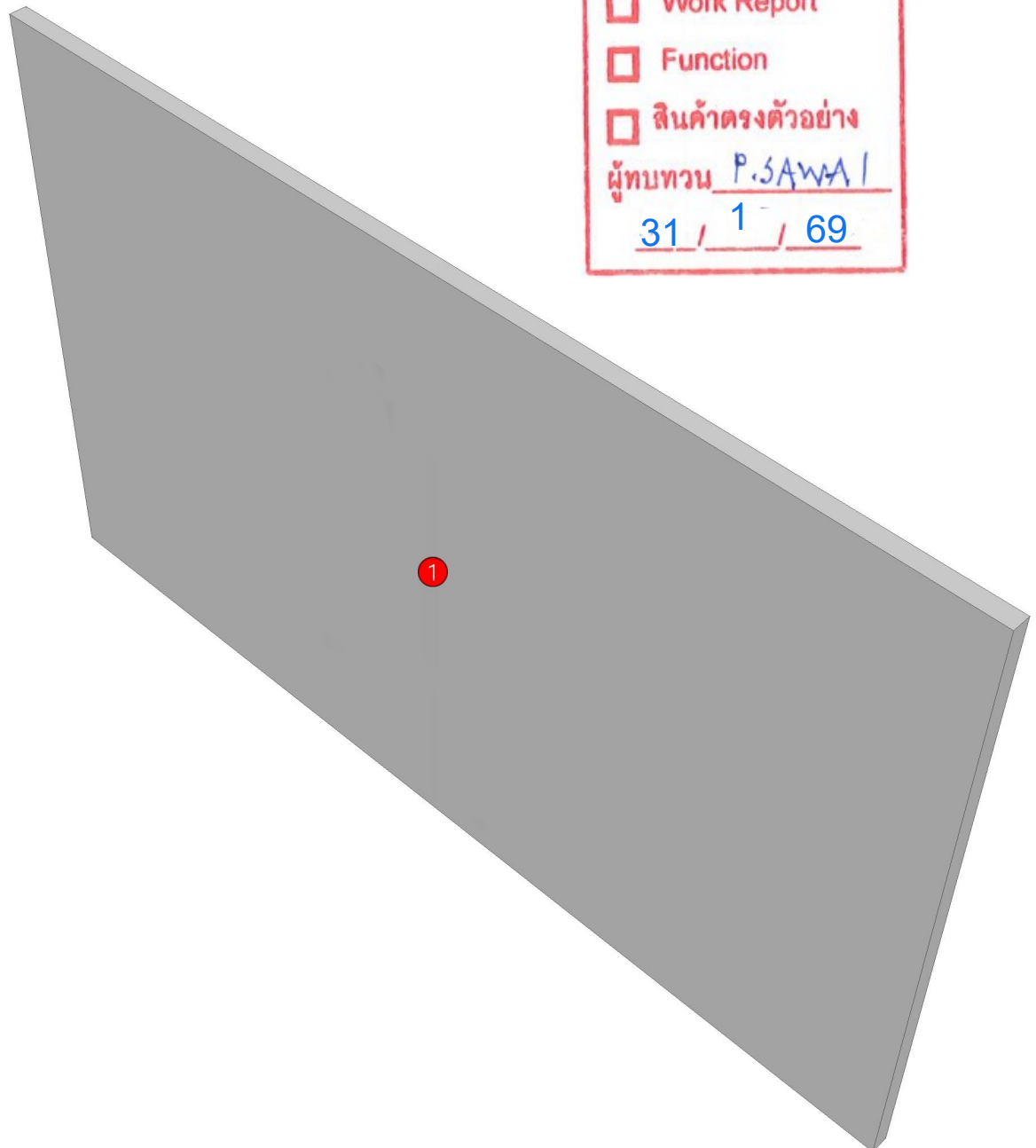

<b>Model</b>	-ESCENT_BNA_DFCL_525H		
<b>Creator</b>	SUTTHI.P	<b>.BCP Name</b>	INDEX_C3D_KITCHENPAE
<b>Reviewer</b>		<b>Order</b>	0003070
<b>Approves</b>	P. SAWA	<b>Date</b>	30/01/2026

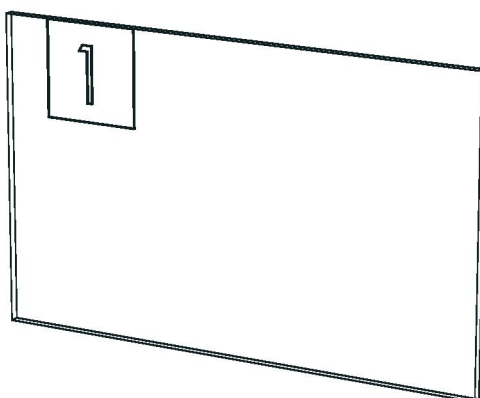

<b>Model</b>	ESCENT_BNA_DFL_		
<b>Creator</b>	SUTTHI.P	<b>.BCP Name</b>	INDEX_C3D_KITCHENPAE
<b>Reviewer</b>		<b>Order</b>	O003076
<b>Approves</b>		<b>Date</b>	01/04/2026

## **ESCENT\_BNA\_DFL\_-150X300X640**

### **Colour**

05.01=ML WHITE VM1012 18/18

05.72=ML.MD645 LONG BEACH (SN)

### **Edge**

01.24=0.6 WHITE

01.392=1 LONG BEACH-MD645 (MW40-A1059TH00)

K3L\_160175451

K3R\_160177246

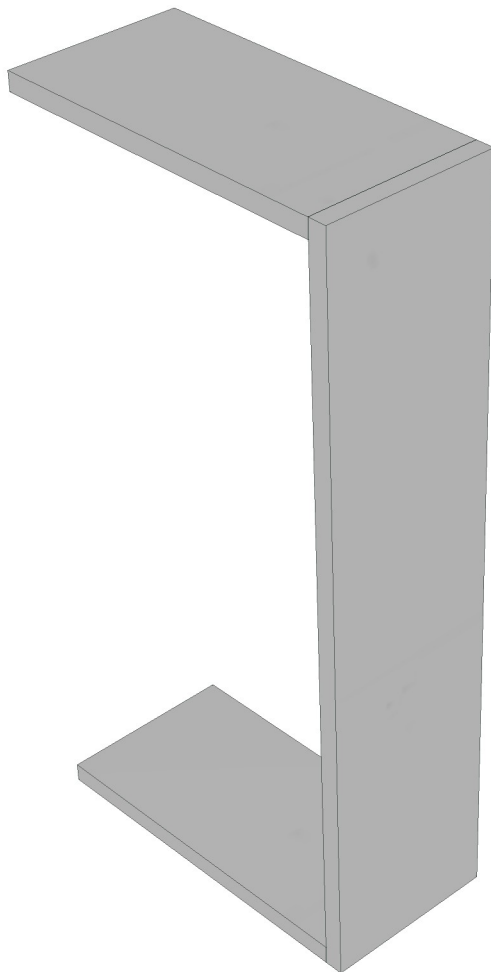

<b>Model</b>	-ESCENT_BNA_DFL_		
<b>Creator</b>		<b>.BCP Name</b>	INDEX_C3D_KITCHENPAE
<b>Reviewer</b>		<b>Order</b>	I003076
<b>Approves</b>		<b>Date</b>	

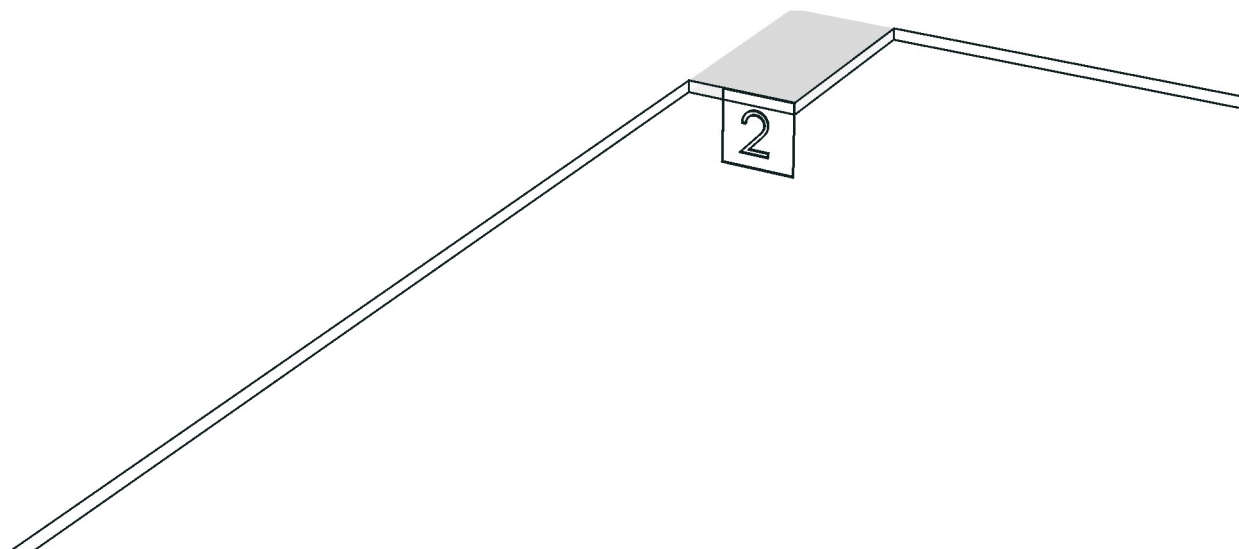
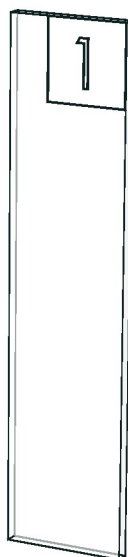

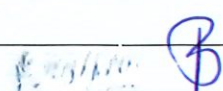
<b>Model</b>	ESCENT_BNA_DL60HL		
<b>Creator</b>	SUTTHI,P	<b>.BCP Name</b>	INDEX_C3D_KITCHENPAE
<b>Reviewer</b>		<b>Order</b>	O003050
<b>Approves</b>		<b>Date</b>	24/01/2026

## ESCENT\_BNA\_DL60HL-600X300X600

**Colour**

05.01=ML WHITE VM1012 18/18  
05.72=ML.MD645 LONG BEACH (SN)

**Edge**

01.24=0.6 WHITE  
01.392=1 LONG BEACH-MD645 (MW40-A1059TH00)

K1R 160175432

K2R 160175441

K3R 160177246

K15R\_160178565



<b>R&amp;D REVIEW</b>	
<input checked="" type="checkbox"/>	DWG.Customer
<input type="checkbox"/>	Work Report
<input checked="" type="checkbox"/>	Function
<input type="checkbox"/>	สินค้าตรงตัวอย่าง
ผู้ทบทวน 	
7 / 5 / 69	

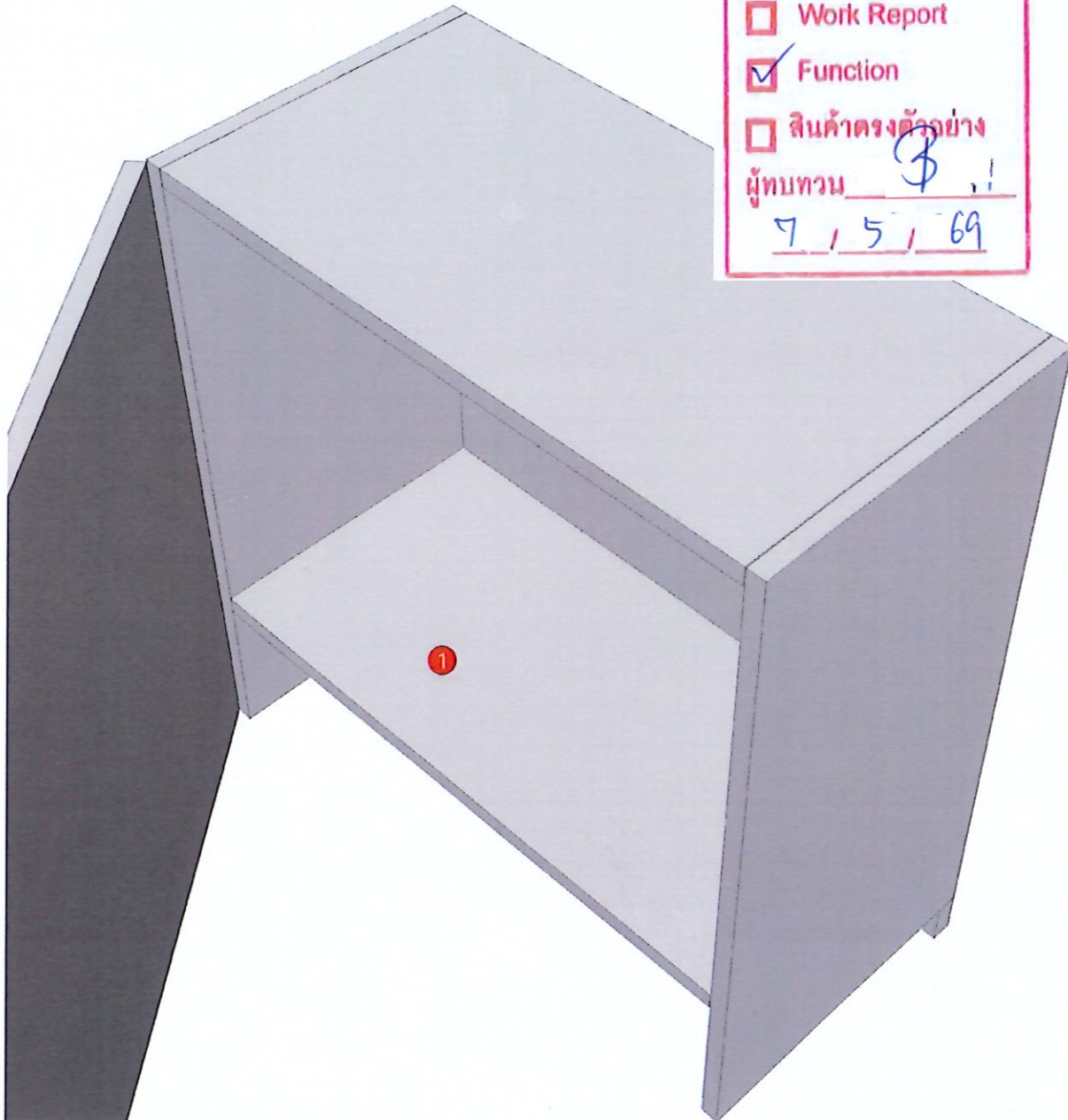

<b>Model</b>	ESCENT_BNA_DUT_1550		
<b>Creator</b>	SUTTHI.P	<b>.BCP Name</b>	INDEX_C3D_KITCHENPAE
<b>Reviewer</b>		<b>Order</b>	O003072
<b>Approves</b>	P.SAWA	<b>Date</b>	30/01/2026

## **ESCENT\_BNA\_DUT\_1550-1550X9X60**

**Colour**

05.01=ML WHITE VM1012 18/18  
05.72=ML.MD645 LONG BEACH (SN)

**Edge**

01.24=0.6 WHITE  
01.392=1 LONG BEACH-MD645 (MW40-A1059TH00)

K2R 160175441

K3L 160175451

K2L 160177236

K3R 160177246

K15R\_160178565

<b>R&amp;D REVIEW</b>	
<input checked="" type="checkbox"/>	DWG.Customer
<input type="checkbox"/>	Work Report
<input type="checkbox"/>	Function
<input type="checkbox"/>	สินค้าตรงตัวอย่าง
ผู้ทบทวน <u>P.SAWA</u>	
<u>31 / 1 / 69</u>	

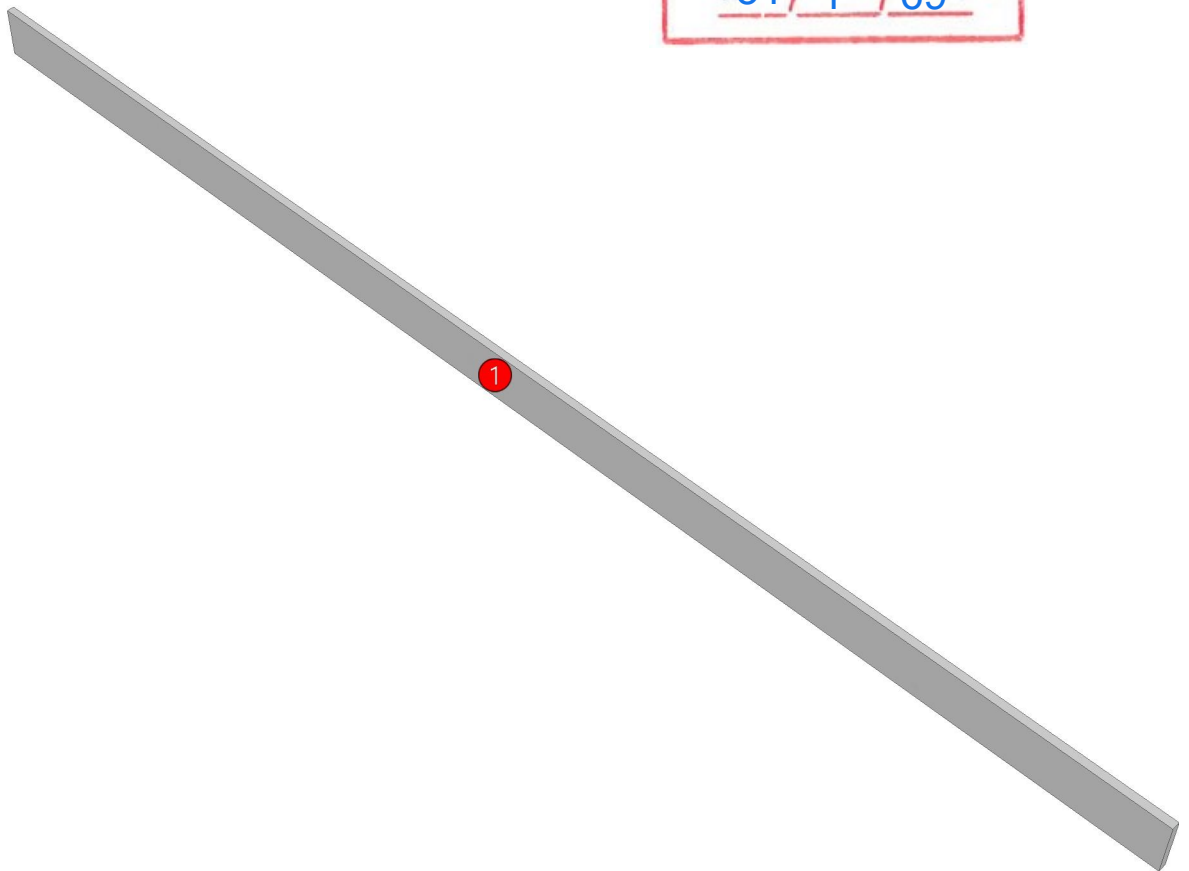

<b>Model</b>	-ESCENT_BNA_DUT_1550		
<b>Creator</b>	SUTTHI.P	<b>.BCP Name</b>	INDEX_C3D_KITCHENPAE
<b>Reviewer</b>		<b>Order</b>	0003072
<b>Approves</b>	P. SAWA	<b>Date</b>	30/01/2026



<b>Model</b>	ESCENT_BNA_DUT_500		
<b>Creator</b>	SUTTHI,P	<b>.BCP Name</b>	INDEX_C3D_KITCHENPAE
<b>Reviewer</b>		<b>Order</b>	O003073
<b>Approves</b>		<b>Date</b>	30/01/2026

## ESCENT\_BNA\_DUT\_500-500X9X60

### Colour

05.01=ML WHITE VM1012 18/18  
05.72=ML.MD645 LONG BEACH (SN)

### Edge

01.24=0.6 WHITE  
01.392=1 LONG BEACH-MD645 (MW40-A1059TH00)

K1R 160175432

K2R 160175441

K3L 160175451

K1L 160177227

K2L 160177236

K3R 160177246

K15R\_160178565



<b>R&amp;D REVIEW</b>	
<input checked="" type="checkbox"/>	DWG.Customer
<input type="checkbox"/>	Work Report
<input checked="" type="checkbox"/>	Function
<input type="checkbox"/>	สินค้าตรงตัวอย่าง
ผู้ทบทวน 	
๗, ๕, ๖๙	

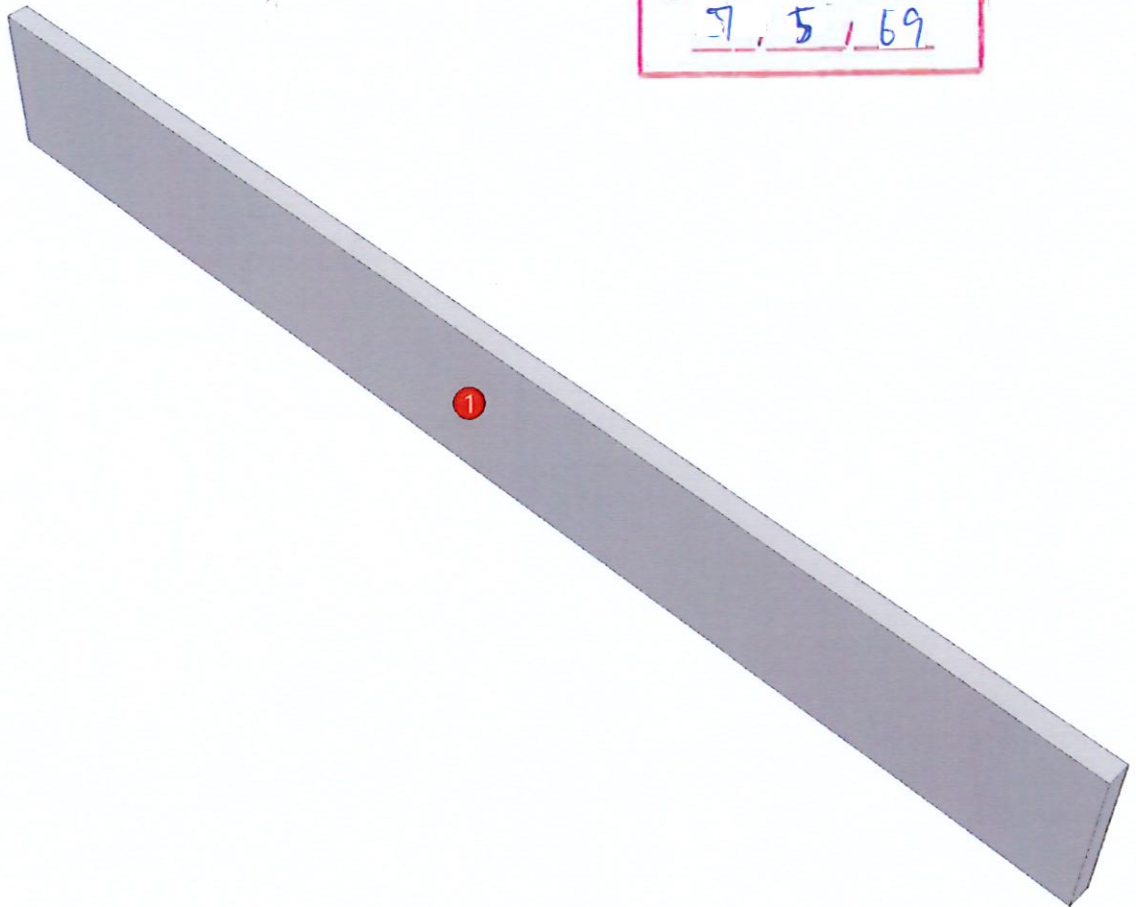

<b>Model</b>	ESCENT_BNA_DW85R		
<b>Creator</b>	SUTTHI.P	<b>.BCP Name</b>	INDEX_C3D_KITCHENPAE
<b>Reviewer</b>		<b>Order</b>	O003102
<b>Approves</b>	<i>P.SAWA</i>	<b>Date</b>	20/02/2026

## **ESCENT\_BNA\_DW85R-850X300X400**

**Colour**

05.01=ML WHITE VM1012 18/18  
05.72=ML.MD645 LONG BEACH (SN)

**Edge**

01.24=0.6 WHITE  
01.392=1 LONG BEACH-MD645 (MW40-A1059TH00)

**K3R 160177246**

**K15R\_160178565**

<b>R&amp;D REVIEW</b>	
<input checked="" type="checkbox"/>	DWG.Customer
<input type="checkbox"/>	Work Report
<input type="checkbox"/>	Function
<input type="checkbox"/>	สินค้าตรงตัวอย่าง
ผู้ทบทวน <i>P.SAWA</i>	
<i>11 / 3 / 69</i>	

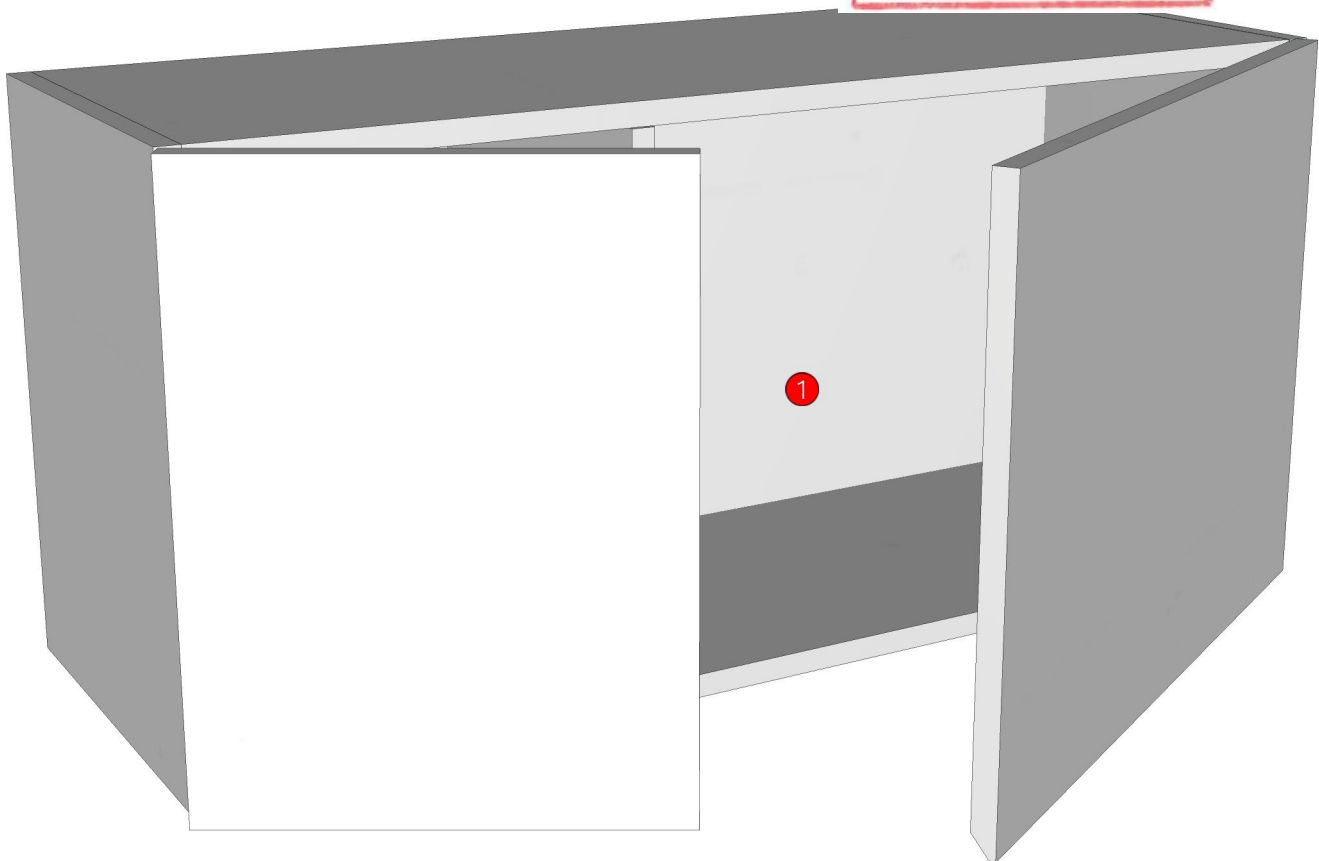

<b>Model</b>	-ESCENT_BNA_DW85R		
<b>Creator</b>	SUTTHI.P	<b>.BCP Name</b>	INDEX_C3D_KITCHENPAE
<b>Reviewer</b>		<b>Order</b>	O003102
<b>Approves</b>	<i>P. SAWA</i>	<b>Date</b>	20/02/2026

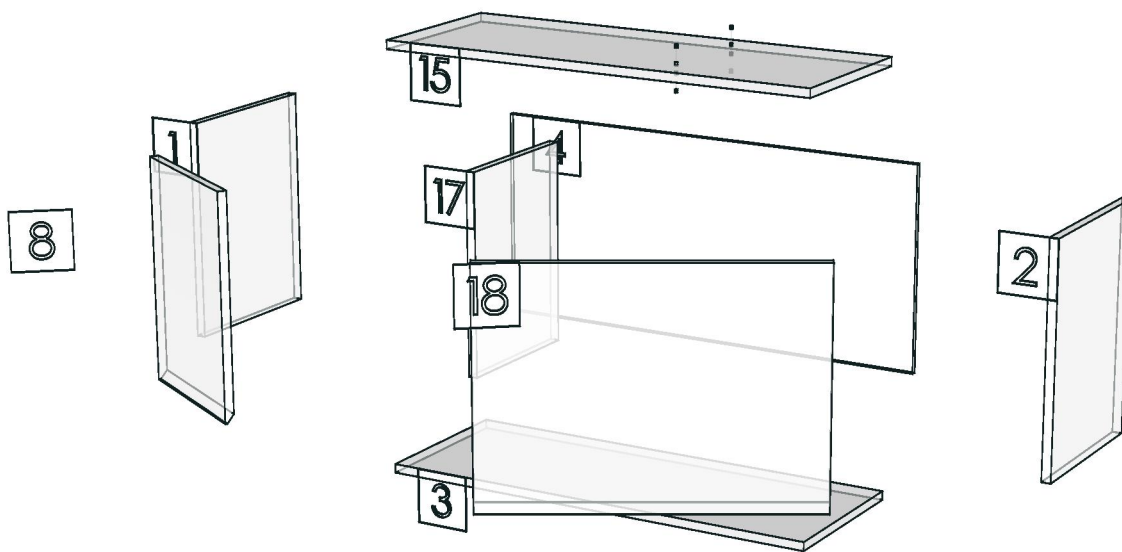

<b>Model</b>	ESCENT_BNA_DWO85		
<b>Creator</b>	SUTTHI.P	<b>.BCP Name</b>	INDEX_C3D_KITCHENPAE
<b>Reviewer</b>		<b>Order</b>	O003058
<b>Approves</b>	P. SAWA	<b>Date</b>	29/01/2026

## **ESCENT\_BNA\_DWO85-850X300X240**

**Colour**

05.01=ML WHITE VM1012 18/18  
05.72=ML.MD645 LONG BEACH (SN)

**Edge**

01.24=0.6 WHITE  
01.392=1 LONG BEACH-MD645 (MW40-A1059TH00)

K3L 160175451

K3R 160177246

K15R\_160178565

<b>R&amp;D REVIEW</b>	
<input checked="" type="checkbox"/>	DWG.Customer
<input type="checkbox"/>	Work Report
<input type="checkbox"/>	Function
<input type="checkbox"/>	สินค้าตรงตัวอย่าง
ผู้ทบทวน <u>P.SAWA</u>	
<u>31 / 1 / 69</u>	

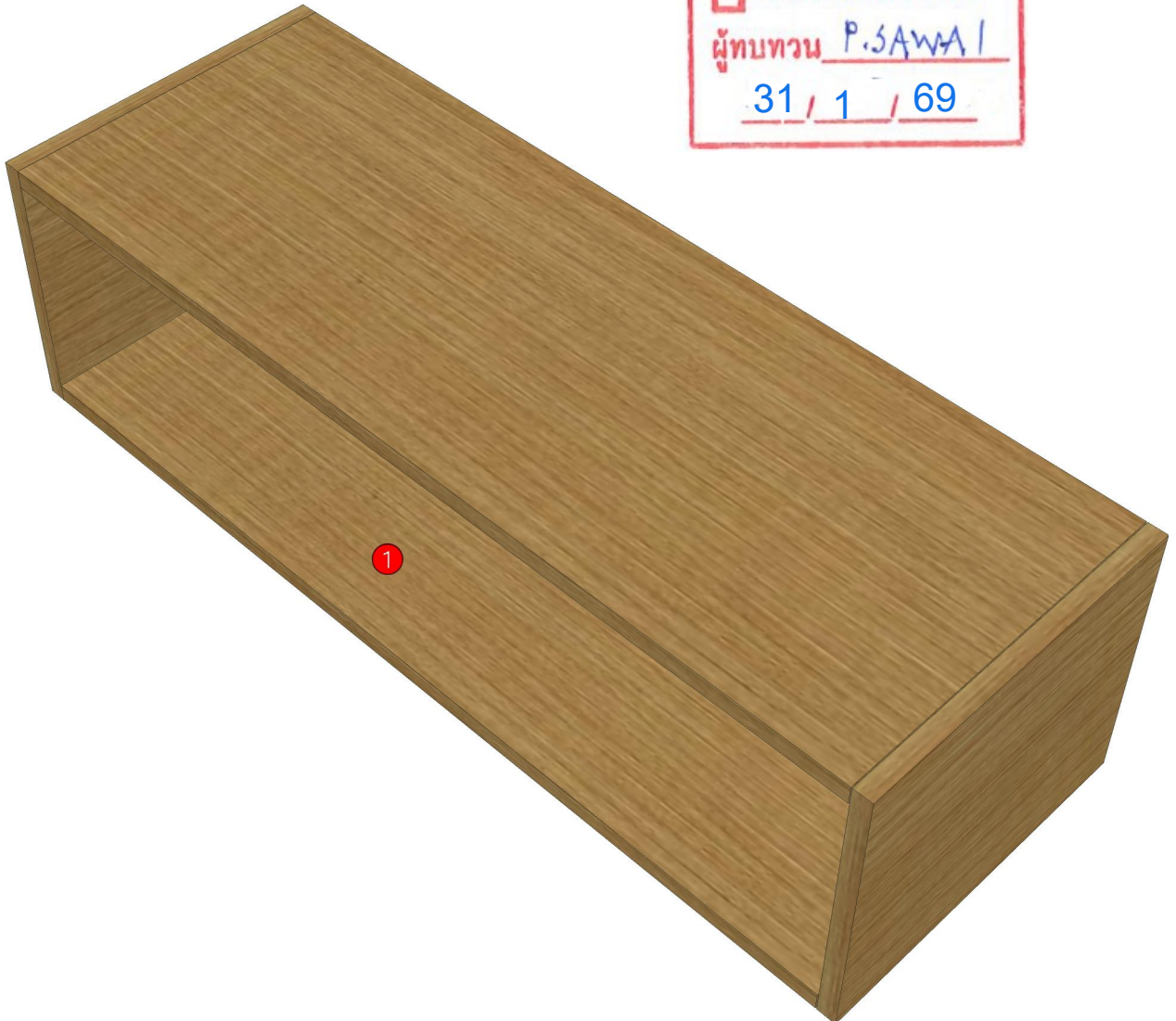

<b>Model</b>	-ESCENT_BNA_DW085		
<b>Creator</b>	SUTTHI.P	<b>.BCP Name</b>	INDEX_C3D_KITCHENPAE
<b>Reviewer</b>		<b>Order</b>	0003058
<b>Approves</b>	<i>P. SAWA</i>	<b>Date</b>	29/01/2026

