

Model	ESCENT_UB2_DBH602GL		
Creator	PASATHORN	.BCP Name	INDEX_C3D_KITCHEN2
Reviewer		Order	I004962
Approves		Date	03/04/2026

ESCENT_UB2_DBH602GL-600X570X922

Colour

03.41 PVC T.0.13 MM.?? BEIGE MFI599_
05.41 ML FOSS ZILK# BK2 (CROSS METAL)_
06.01 TEXTURE DEAD STOCK_
-
-

Edge

01.319 1 MFI599 PEARL _
01.299 1 FOSS ZILK BK2 A1285 TH00 _
-
-
-

R&D REVIEW	
<input checked="" type="checkbox"/>	DWG.Customer
<input checked="" type="checkbox"/>	Work Report
<input type="checkbox"/>	Function
<input type="checkbox"/>	สินค้าตรงตัวอย่าง
ผู้ทบทวน _____	

K5L-160177265

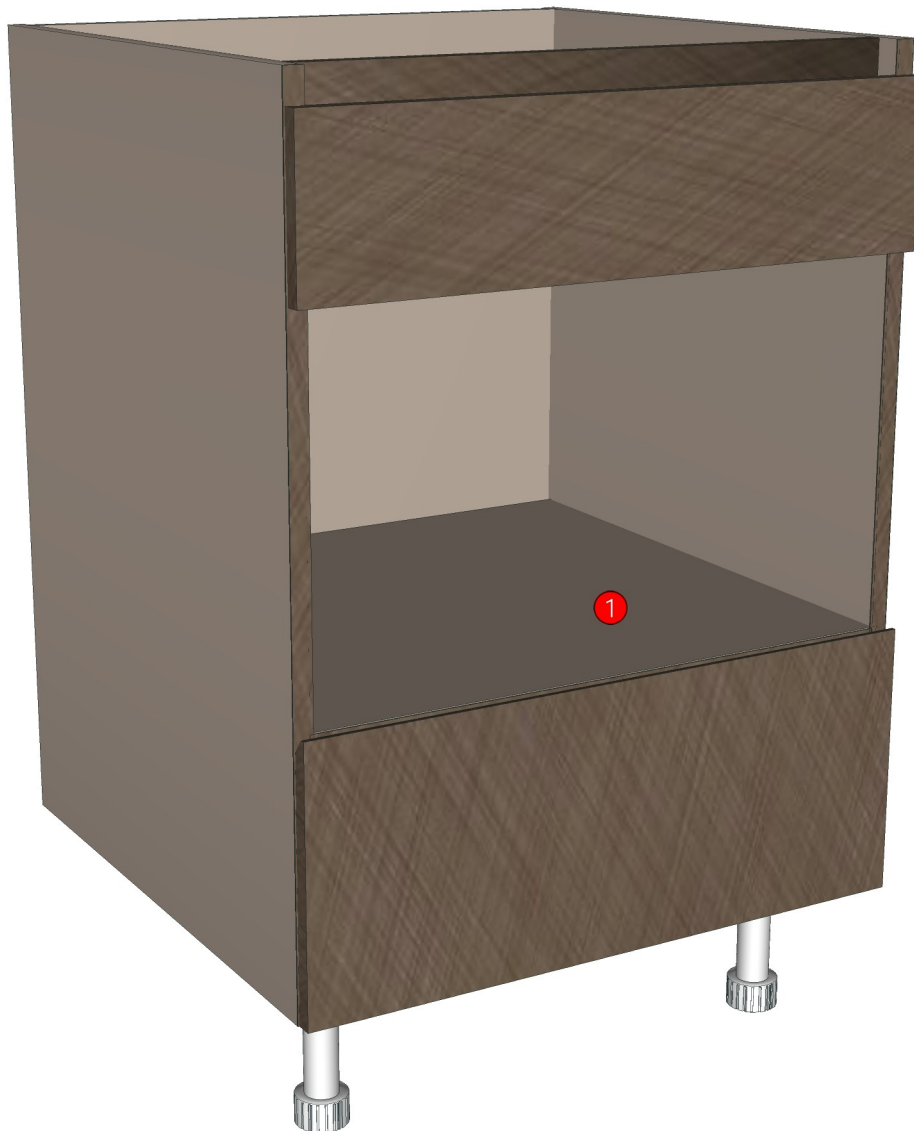

Model	-ESCENT_UB2_DBH602GL		
Creator		.BCP Name	INDEX_C3D_KITCHEN2
Reviewer		Order	I004962
Approves		Date	

9

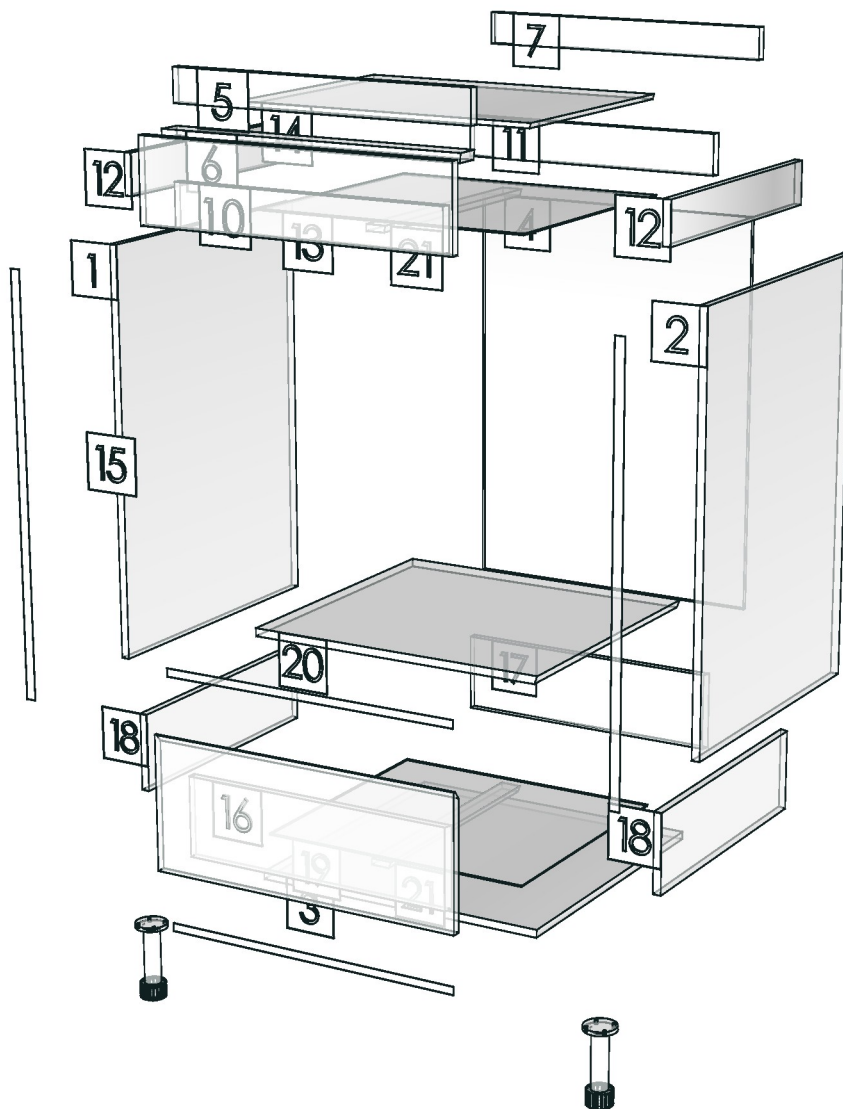

Model	ESCENT_UB2_DBS60LGR		
Creator	PASATHORN	.BCP Name	INDEX_C3D_KITCHEN2
Reviewer		Order	I004961
Approves		Date	03/04/2026

ESCENT_UB2_DBS60LGR-600X570X922

Colour

03.41 PVC T.0.13 MM.?? BEIGE MFI599_
05.41 ML FOSS ZILK# BK2 (CROSS METAL)_

-
-
-

Edge

01.319 1 MFI599 PEARL _
01.299 1 FOSS ZILK BK2 A1285 TH00 _

-
-
-

R&D REVIEW	
<input checked="" type="checkbox"/>	DWG.Customer
<input checked="" type="checkbox"/>	Work Report
<input type="checkbox"/>	Function
<input type="checkbox"/>	สินค้าตรงตัวอย่าง
ผู้ทบทวน _____	

K5L-160177265



Model	-ESCENT_UB2_DBS60LGR		
Creator		.BCP Name	INDEX_C3D_KITCHEN2
Reviewer		Order	I004961
Approves		Date	

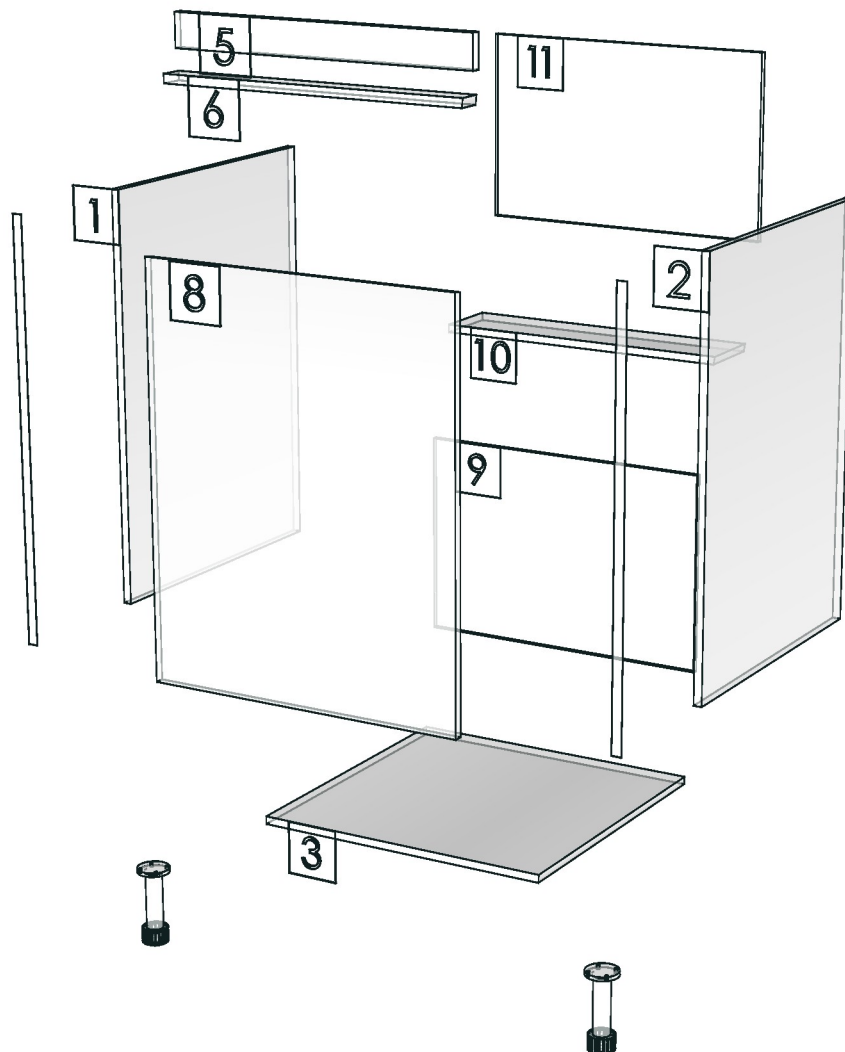

Model	ESCENT_UB2_DEPB		
Creator	PASATHORN	.BCP Name	INDEX_C3D_KITCHEN2
Reviewer		Order	I003204
Approves		Date	02/07/2024

ESCENT_UB2_DEPB-16X590X772

Colour

05.41 ML FOSS ZILK# BK2 (CROSS METAL)_

-

-

-

K1L-160177280_ED



K1R-160170715

K2L-160177289_ED



K2R-160147377

K3L-160147386_ED



K3R-160170724

K4R-160170734

K5L-160177265_ED



K7L-160170744

K8R-160170757

Edge

01.299 1 FOSS ZILK BK2 A1285 TH00 _

-

-

-

-

K9L-160170770

K1100R-160170780



Model	ESCENT_UB2_DEPB		
Creator	PASATHORN	.BCP Name	INDEX_C3D_KITCHEN2
Reviewer		Order	I003204
Approves		Date	02/07/2024

No.	Article No.	Description	Mat	Dimension	Cutting Size	Typepology	Skin
0	ESCENT_UB2_DEPB	ESCENT_UB2_DEPB		16x772x590			
	ESCENT_UB2_DEPB-01	DEP-SP	PB-	16x590x772	16X588X770;L2:W2	181000_STR=05.41_EDG=A1285TH00-1	2

Model	ESCENT_UB2_DFB		
Creator	PASATHORN	.BCP Name	INDEX_C3D_KITCHEN2
Reviewer		Order	I003201
Approves		Date	02/07/2024





ESCENT_UB2_DFB-150X16X772

Colour

03.41 PVC T.0.13 MM.?? BEIGE MFI599_ED
05.41 ML FOSS ZILK# BK2 (CROSS METAL)_

Edge

01.319 1 MFI599 PEARL _
01.299 1 FOSS ZILK BK2 A1285 TH00 _

-
-
- K1L-160177280_ED  K9L-160170770
- K1R-160170715  K1100R-160170780
- K2L-160177289_ED 
- K2R-160147377
- K3L-160147386_ED 
- K3R-160170724
- K4R-160170734
- K5L-160177265_ED 
- K7L-160170744
- K8R-160170757

R&D REVIEW

- DWG.Customer
- Work Report
- Function
- สินค้าตรงตัวอย่าง

ผู้ทบทวน 



Model	-ESCENT_UB2_DFB		
Creator		.BCP Name	INDEX_C3D_KITCHEN2
Reviewer		Order	I003201
Approves		Date	

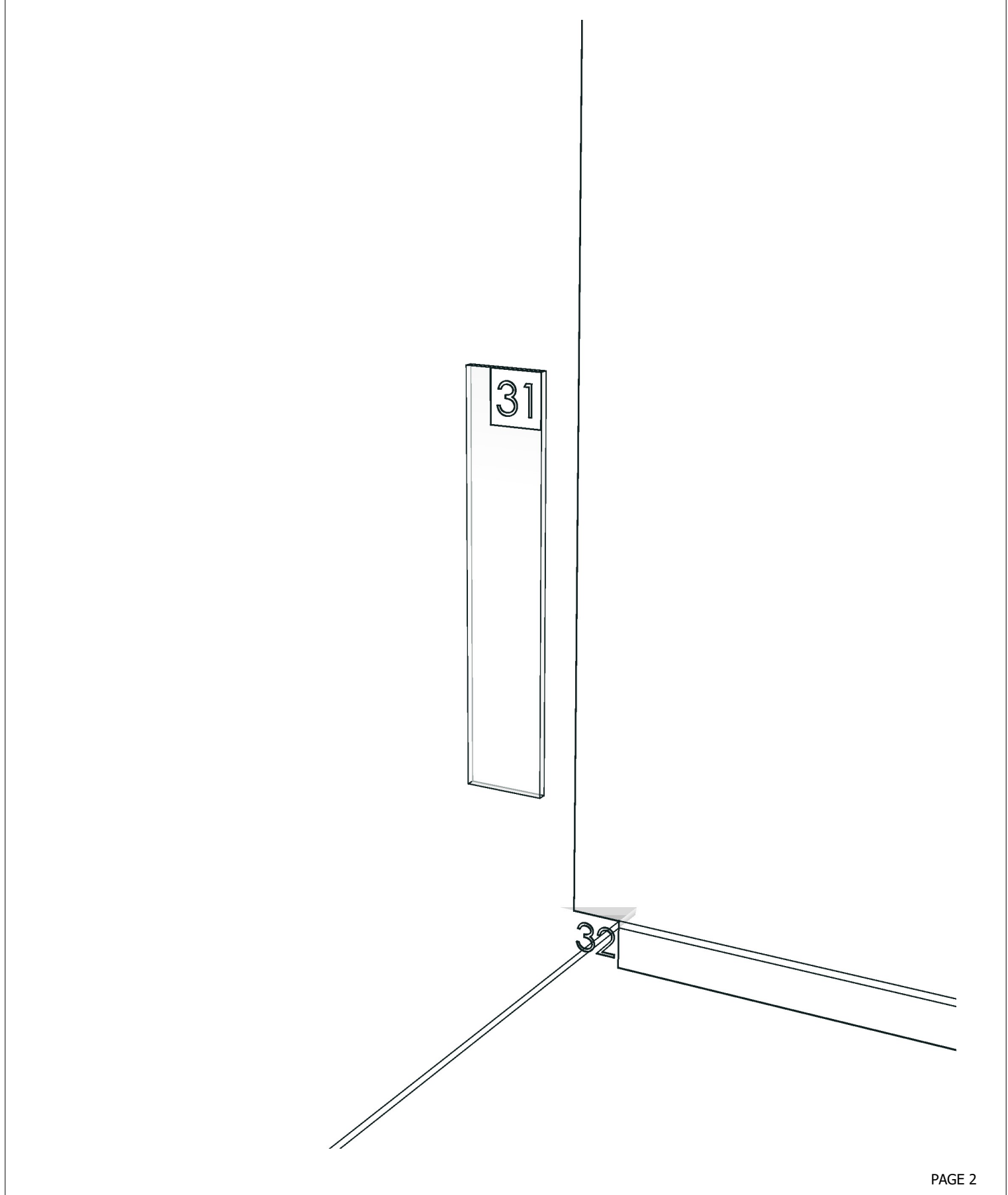

Model	ESCENT_UB2_DFL		
Creator	PASATHORN	.BCP Name	INDEX_C3D_KITCHEN2
Reviewer		Order	I003202
Approves		Date	02/07/2024

ESCENT_UB2_DFL-150X16X640

Colour

03.41 PVC T.0.13 MM.?? BEIGE MFI599_

-

-

-

-

K9L-160170770

K1100R-160170780

Edge

01.319 1 MFI599 PEARL _

-

-

-

-



K3L-160147386_ED



K3R-160170724

K4R-160170734

K5L-160177265_ED



K8R-160170757

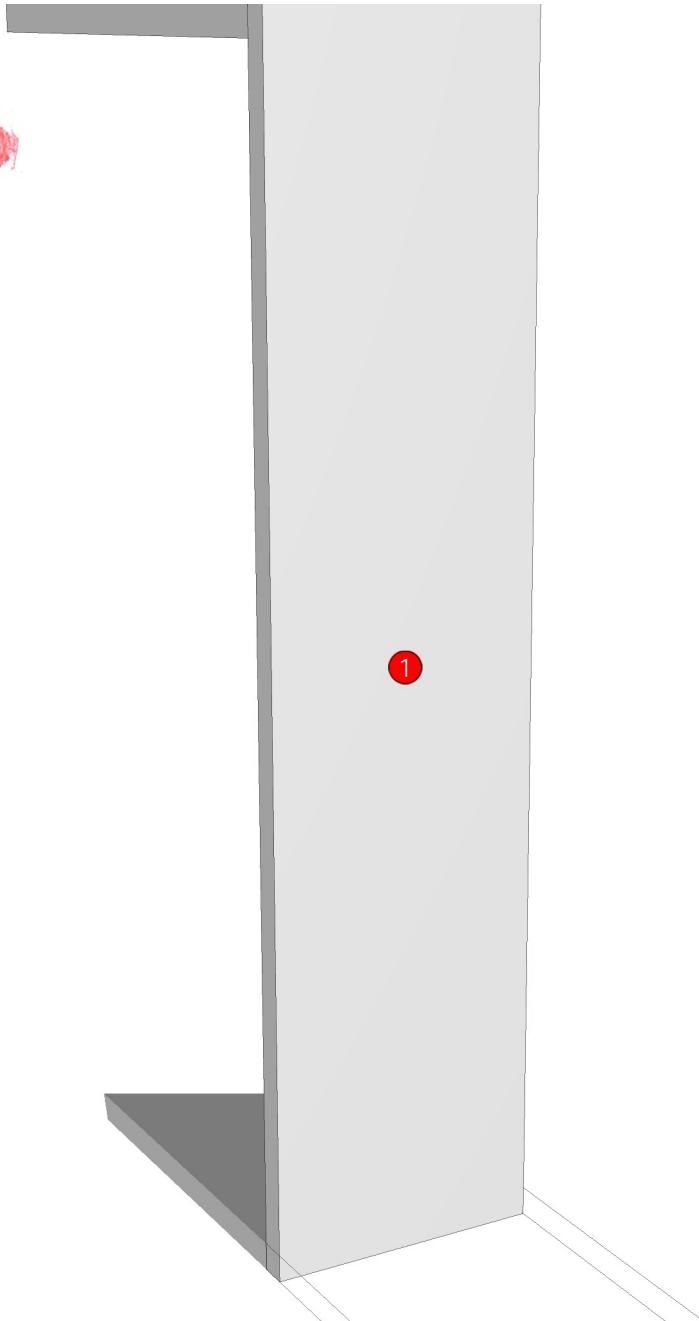

Model	-ESCENT_UB2_DFL		
Creator		.BCP Name	INDEX_C3D_KITCHEN2
Reviewer		Order	I003202
Approves		Date	

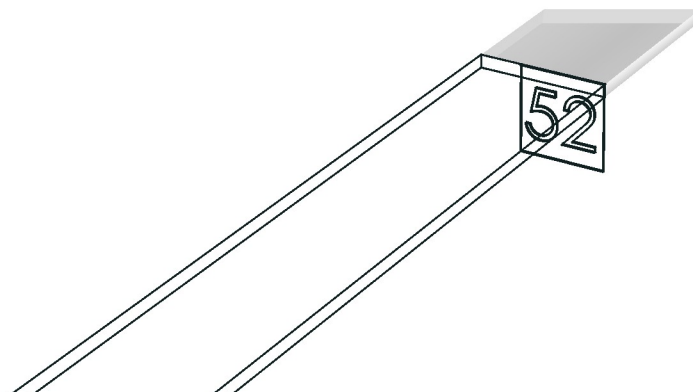
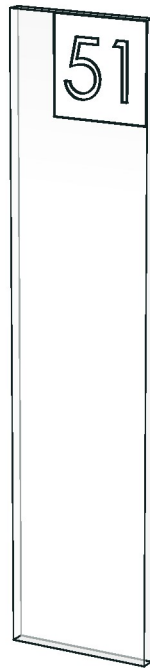
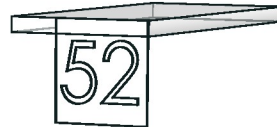

Model	ESCENT_UB2_DF_CL2100		
Creator	PASATHORN	.BCP Name	INDEX_C3D_KITCHEN2
Reviewer		Order	I004591
Approves		Date	04/11/2025

ESCENT_UB2_DF_CL2100-2100X9X370

Colour

03.41 PVC T.0.13 MM.?? BEIGE MFI599_

-
-
-
-

Edge

01.319 1 MFI599 PEARL _

-
-
-
-





K5L-160177265_ED

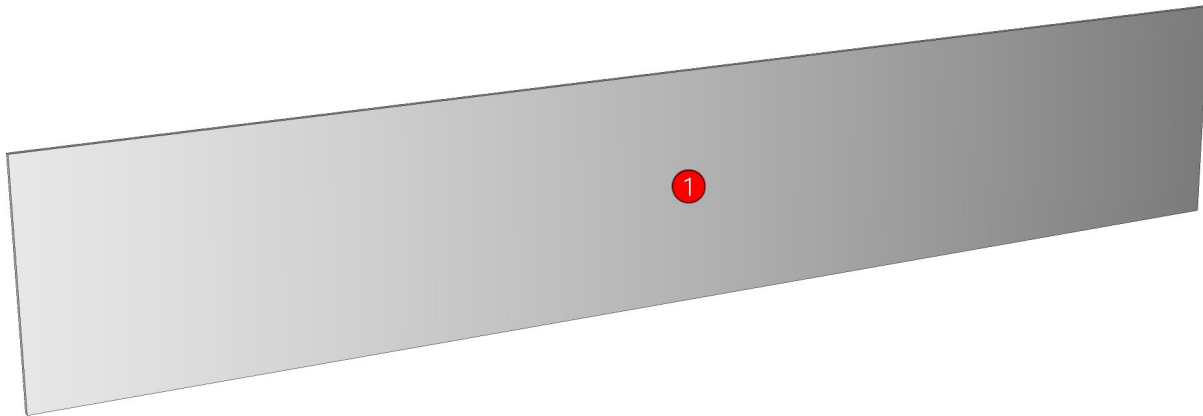

K8R-160170757



Model	ESCENT_UB2_DF_CL2100		
Creator	PASATHORN	.BCP Name	INDEX_C3D_KITCHEN2
Reviewer		Order	I004591
Approves		Date	04/11/2025

No.	Article No.	Description	Mat	Dimension	Cutting Size	Typepology	Skin
0	ESCENT_UB2_DF_ESCENT_UB2_DF_CL2100	ESCENT_UB2_DF_CL2100		2100x370x9			
	ESCENT_UB2_DF_CL2100-01	DFCL_ED-SP	 PB-ST	9x370x2100	9X369X2099;L1:W1	183000_STR=03.41_EDG=MFI599 PEARL-1	2

Model	ESCENT_UB2_DF_CL300		
Creator	PASATHORN	.BCP Name	INDEX_C3D_KITCHEN2
Reviewer		Order	I004584
Approves		Date	04/11/2025

ESCENT_UB2_DF_CL300-300X9X370

Colour

03.41 PVC T.0.13 MM.?? BEIGE MFI599_

-

-

-

K1L-160177280_ED



K1R-160170715

Edge

01.319 1 MFI599 PEARL _

-

-

-

-

K9L-160170770

K1100R-160170780

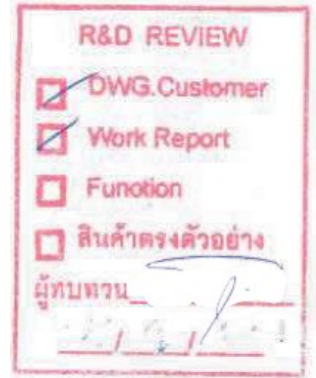



K4R-160170734

K5L-160177265_ED

K7L-160170744

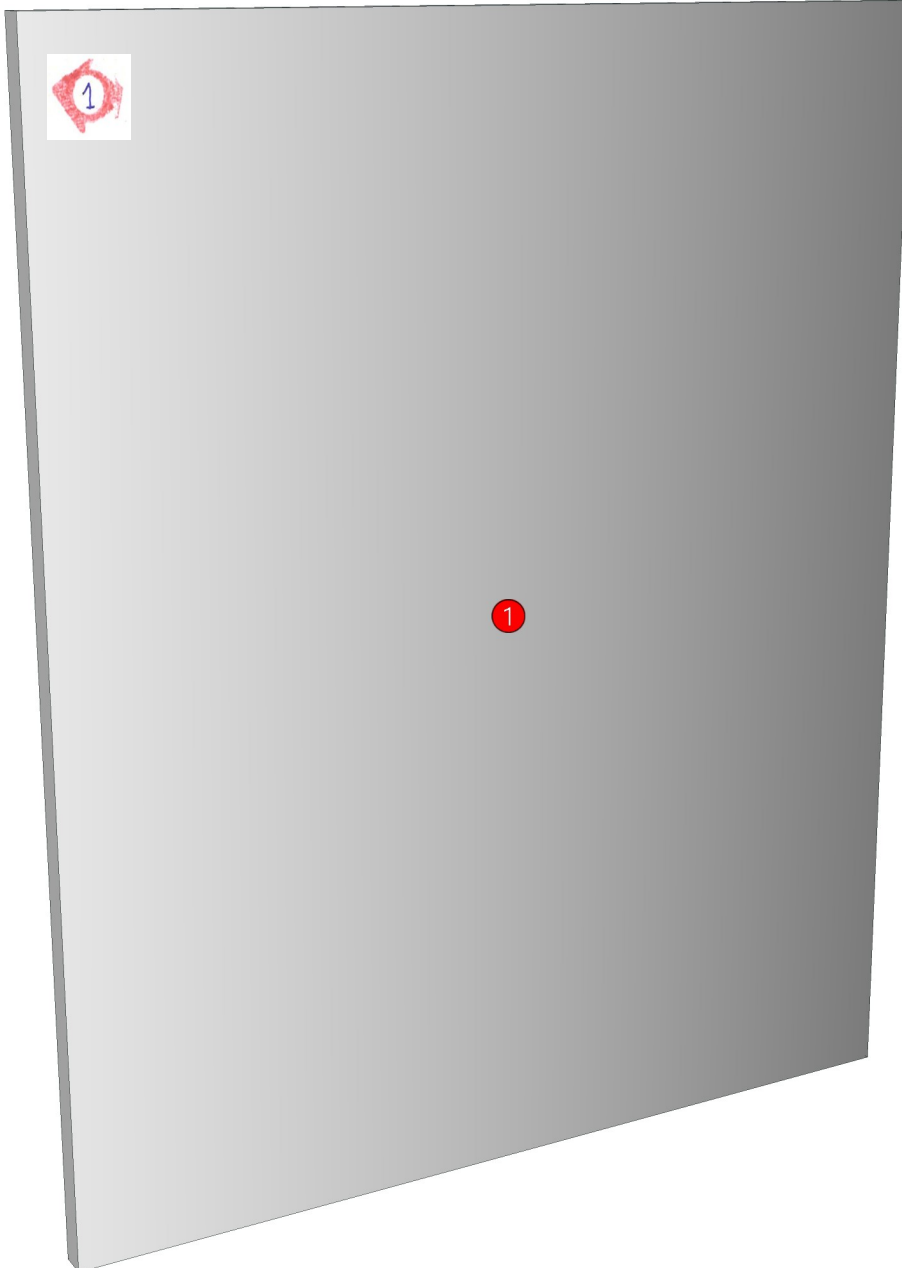
K8R-160170757



Model	ESCENT_UB2_DF_CL300		
Creator	PASATHORN	.BCP Name	INDEX_C3D_KITCHEN2
Reviewer		Order	I004584
Approves		Date	04/11/2025

No.	Article No.	Description	Mat	Dimension	Cutting Size	Typepology	Skin
0	ESCENT_UB2_DF_	ESCENT_UB2_DF_CL300		300x370x9			
	ESCENT_UB2_DF_CL300-01	DFCL_ED-SP	 PB-ST	9x370x300	9X369X299;L1:W1	183000_STR=03.41_EDG=MFI599 PEARL-1	2

Model	ESCENT_UB2_DL60HR		
Creator	PASATHORN	.BCP Name	INDEX_C3D_KITCHEN2
Reviewer		Order	I003208
Approves		Date	03/07/2024

ESCENT_UB2_DL60HR-600X300X600

Colour

03.41 PVC T.0.13 MM.?? BEIGE MFI599_

-

-

-

K1L-160177280

K9L-160170770

K2L-160177289

K3L-160147386

K5L-160177265

Edge

01.319 1 MFI599 PEARL _

-

-

-

-

R&D REVIEW

- DWG.Customer
- Work Report
- Function
- สินค้าตรงตัวอย่าง

ผู้ทบทวน _____

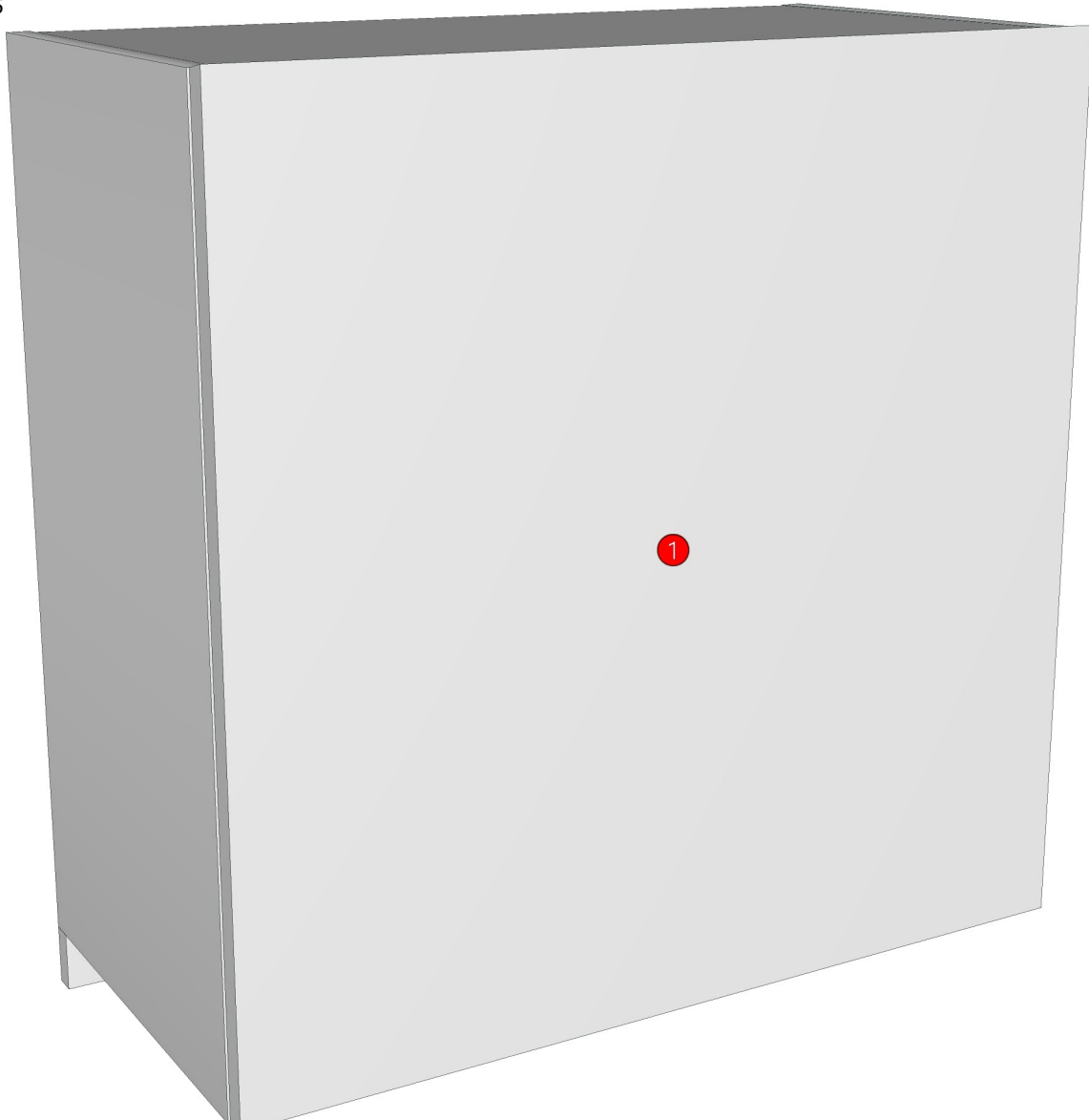

Model	-ESCENT_UB2_DL60HR		
Creator		.BCP Name	INDEX_C3D_KITCHEN2
Reviewer		Order	I003208
Approves		Date	

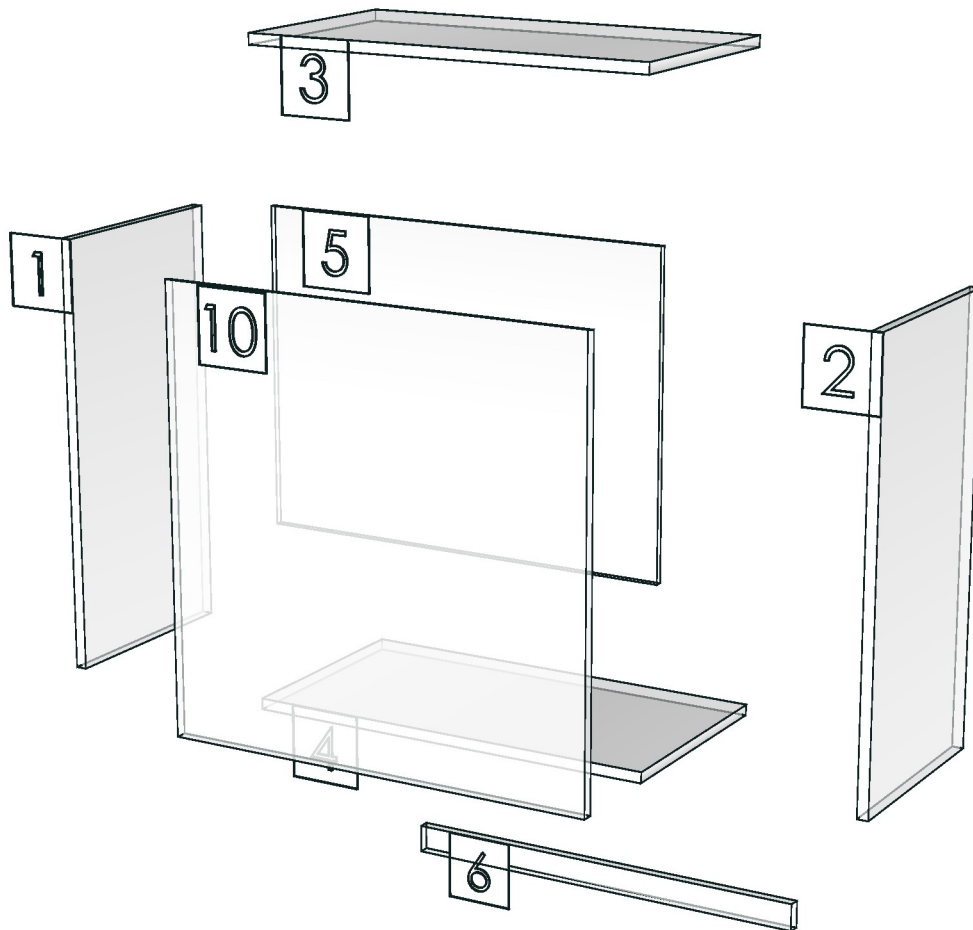

Model	ESCENT_UB2_DUT2100		
Creator	PASATHORN	.BCP Name	INDEX_C3D_KITCHEN2
Reviewer		Order	I004583
Approves		Date	04/11/2025

ESCENT_UB2_DUT2100-2100X60X9

Colour

05.01 ML WHITE VM1012 18/18_

-
-
-
-

Edge

01.47 1 WHITE _

-
-
-
-



K5L-160177265_ED



K8R-160170757

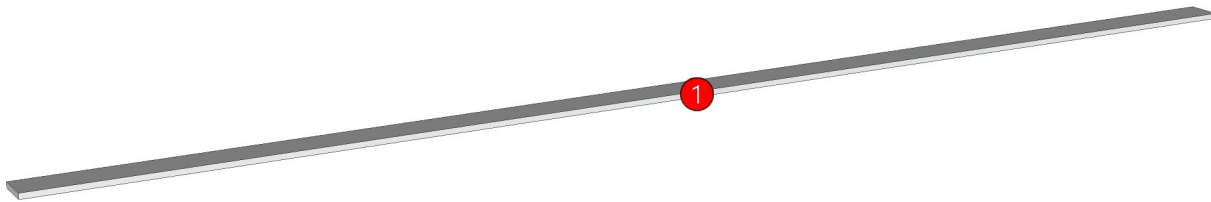

Model	ESCENT_UB2_DUT2100		
Creator	PASATHORN	.BCP Name	INDEX_C3D_KITCHEN2
Reviewer		Order	I004583
Approves		Date	04/11/2025

No.	Article No.	Description	Mat	Dimension	Cutting Size	Typepology	Skin
0	ESCENT_UB2_DUT2100	ESCENT_UB2_DUT2100		2100x9x60			
	ESCENT_UB2_DUT2100-01	DUT-SP	PB-ST	9x60x2100	9X58X2100;L2:W0	182000 _STR=05.01 _EDG=WHITE-1	2

Model	ESCENT_UB2_DUT500		
Creator	PASATHORN	.BCP Name	INDEX_C3D_KITCHEN2
Reviewer		Order	I003197
Approves		Date	02/07/2024

ESCENT_UB2_DUT500-500X60X9

Colour

05.01 ML WHITE VM1012 18/18_

-

-

-

K1L-160177280_ED



K1R-160170715

K2L-160177289_ED



K2R-160147377

K3L-160147386_ED



K3R-160170724

K4R-160170734

K5L-160177265_ED



K7L-160170744

K8R-160170757

Edge

01.47 1 WHITE _

-

-

-

-

K9L-160170770

K1100R-160170780

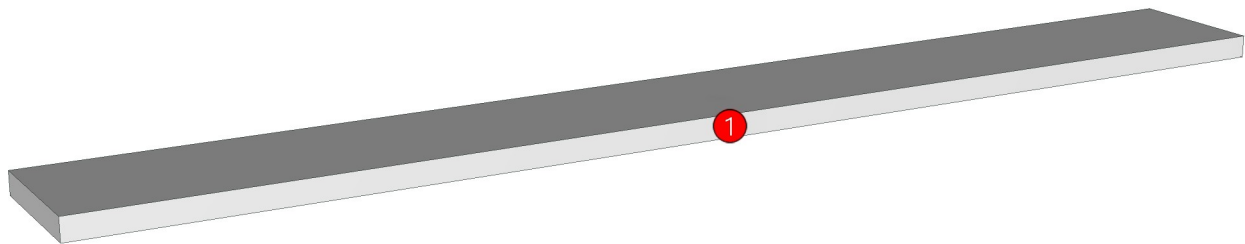
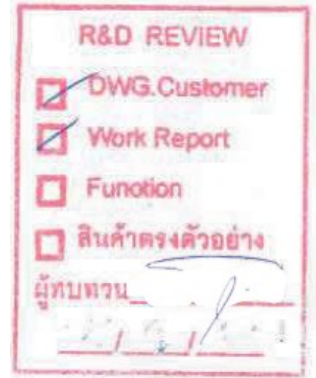

Model	ESCENT_UB2_DUT500		
Creator	PASATHORN	.BCP Name	INDEX_C3D_KITCHEN2
Reviewer		Order	I003197
Approves		Date	02/07/2024

No.	Article No.	Description	Mat	Dimension	Cutting Size	Typepology	Skin
0	ESCENT_UB2_DUT500 ESCENT_UB2_DUT500-01	ESCENT_UB2_DUT500 DUT-SP	PB-ST	500x9x60 9x60x500	9X58X500;L2:W0	182000 _STR=05.01 _EDG=WHITE-1	2

Model	ESCENT_UB2_DW675		
Creator	PASATHORN	.BCP Name	INDEX_C3D_KITCHEN2
Reviewer		Order	I004954
Approves		Date	03/04/2026

ESCENT_UB2_DW675-675X300X400

Colour

03.41 PVC T.0.13 MM.?? BEIGE MFI599_

-
-
-
-

Edge

01.319 1 MFI599 PEARL _

-
-
-
-

R&D REVIEW

- DWG.Customer
- Work Report
- Function
- สินค้าตรงตัวอย่าง

ผู้ทบทวน _____

K5L-160177265

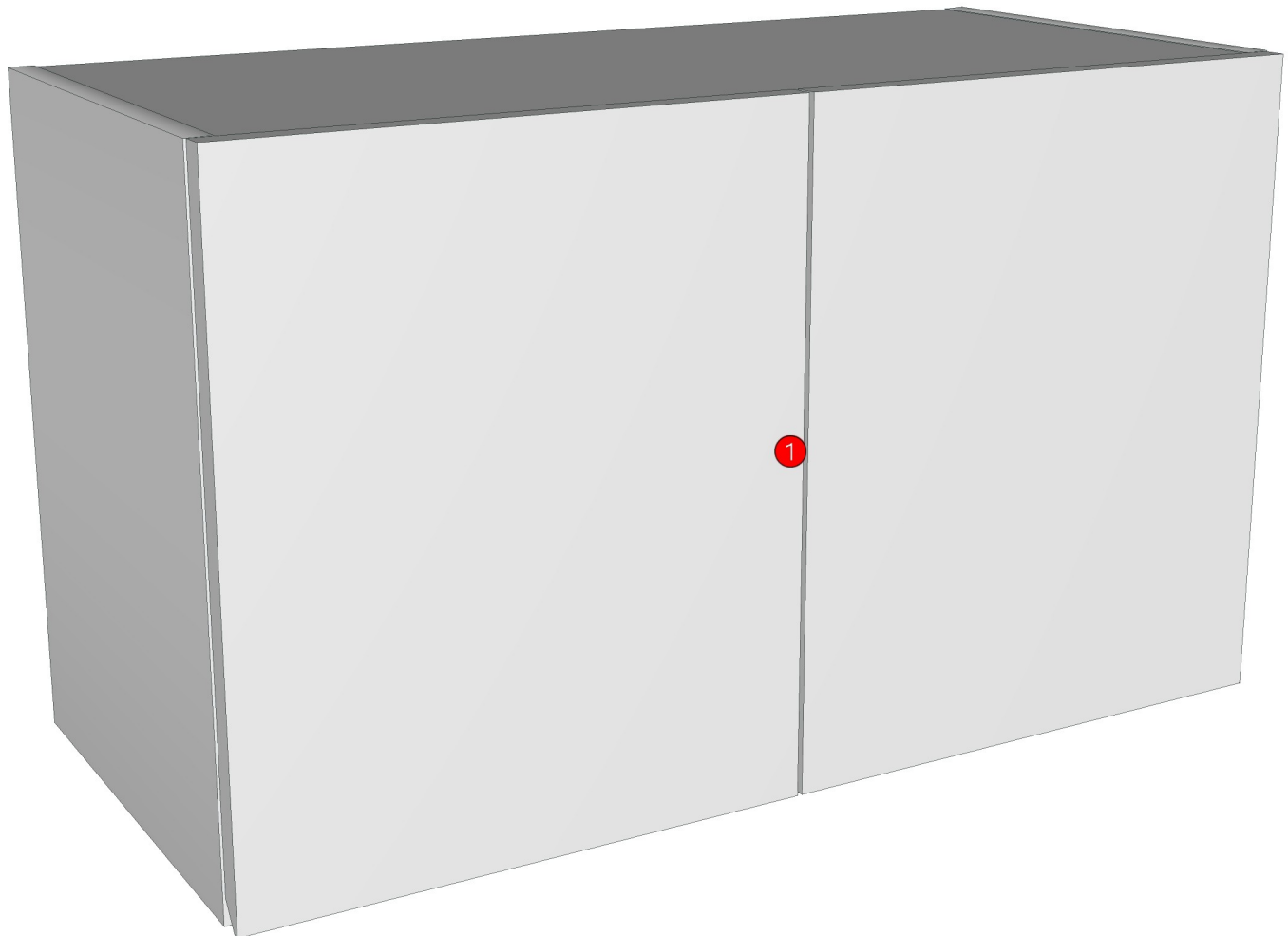

Model	-ESCENT_UB2_DW675		
Creator		.BCP Name	INDEX_C3D_KITCHEN2
Reviewer		Order	I004954
Approves		Date	

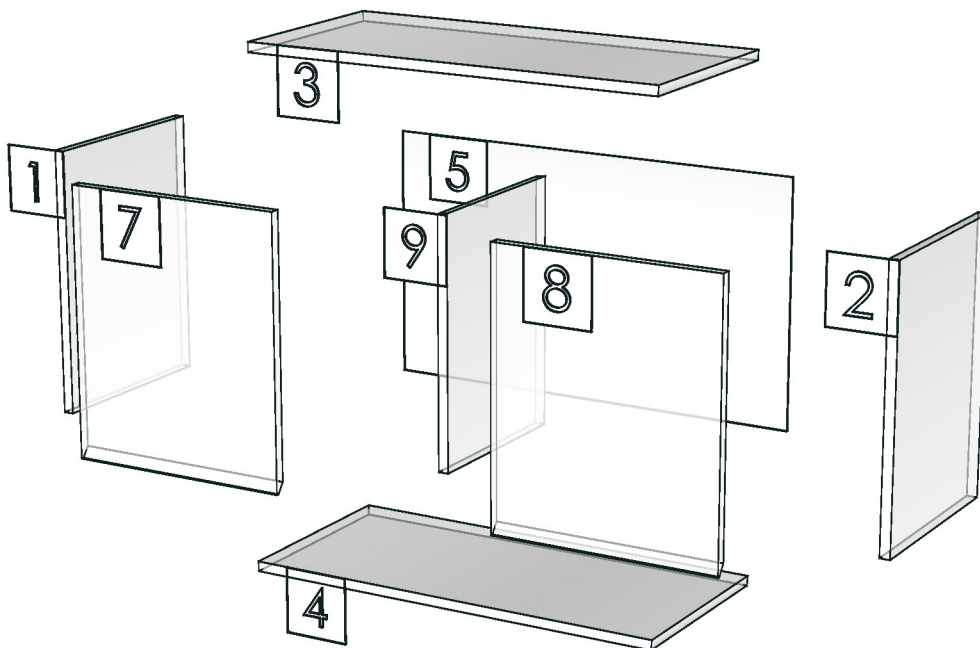

Model	ESCENT_UB2_DWO135		
Creator	PASATHORN	.BCP Name	INDEX_C3D_KITCHEN2
Reviewer		Order	I004956
Approves		Date	03/04/2026

ESCENT_UB2_DWO135-1350X300X240

Colour

05.41 ML FOSS ZILK# BK2 (CROSS METAL)_

-
-
-
-

Edge

01.299 1 FOSS ZILK BK2 A1285 TH00 _

-
-
-
-

R&D REVIEW

DWG.Customer

Work Report

Function

สินค้าตรงตัวอย่าง

ผู้ทบทวน _____

_____/____/____

K5L-160177265

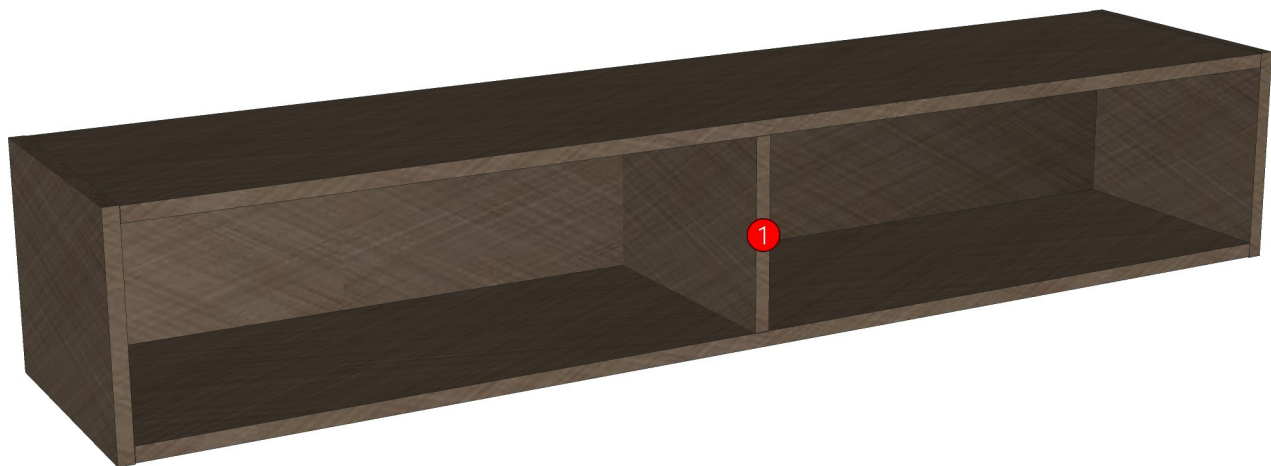

Model	-ESCENT_UB2_DWO135		
Creator		.BCP Name	INDEX_C3D_KITCHEN2
Reviewer		Order	I004956
Approves		Date	

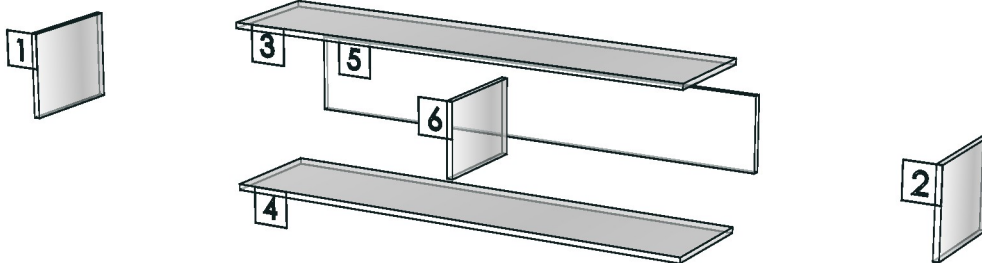

Model	ESCENT_UB2_D_FLR734S		
Creator	PASATHORN	.BCP Name	INDEX_C3D_KITCHEN2
Reviewer		Order	I004955
Approves		Date	03/04/2026

ESCENT_UB2_D_FLR734S-734X570X60

Colour

03.41 PVC T.0.13 MM.?? BEIGE MFI599_
05.41 ML FOSS ZILK# BK2 (CROSS METAL)_

-
-
-

Edge

01.319 1 MFI599 PEARL _
01.299 1 FOSS ZILK BK2 A1285 TH00 _

-
-
-

R&D REVIEW

DWG.Customer

Work Report

Function

สินค้าตรงตัวอย่าง

ผู้ทบทวน _____

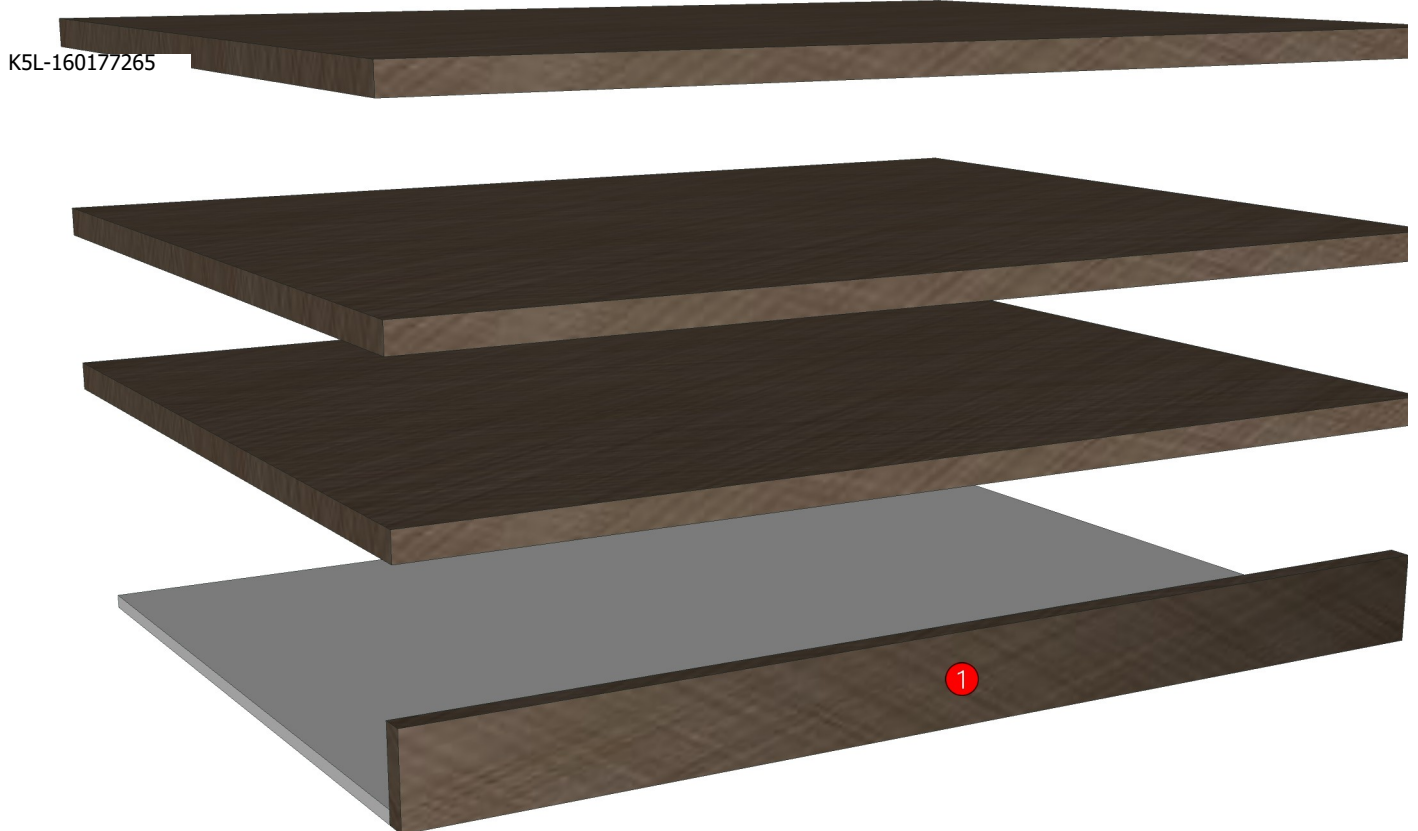

Model	-ESCENT_UB2_D_FLR734S		
Creator		.BCP Name	INDEX_C3D_KITCHEN2
Reviewer		Order	I004955
Approves		Date	

