

|                 |                      |                  |                    |
|-----------------|----------------------|------------------|--------------------|
| <b>Model</b>    | 1PLUS_LIFE2_TOP_103L |                  |                    |
| <b>Creator</b>  | CHALEAMPHON          | <b>.BCP Name</b> | INDEX_C3D_KITCHEN2 |
| <b>Reviewer</b> |                      | <b>Order</b>     | H002380            |
| <b>Approves</b> |                      | <b>Date</b>      | 17/02/2026         |

## **1PLUS\_LIFE2\_TOP\_103L-1402X600X38**

### **Colour**

04.26=LAMINATE HPL #8117-S

04.10=LAMINATE HPL # TD9201PL

30.01=ML WHITE VM1012 18/18 (WET PROTECT)

30.02=NO SURFACE DAMP PROOF WOOD 18/18 (WET PROTECT)

### **Edge**

04.01=0.8 HPL



K103L-160177042

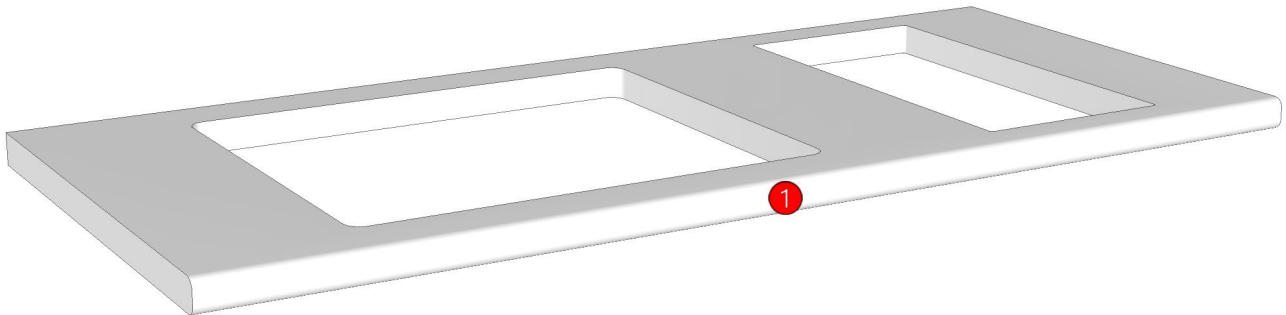

|                 |                      |                  |                    |
|-----------------|----------------------|------------------|--------------------|
| <b>Model</b>    | 1PLUS_LIFE2_TOP_103L |                  |                    |
| <b>Creator</b>  | CHALEAMPON           | <b>.BCP Name</b> | INDEX_C3D_KITCHEN2 |
| <b>Reviewer</b> |                      | <b>Order</b>     | H002380            |
| <b>Approves</b> |                      | <b>Date</b>      | 17/02/2026         |

| No. | Article No.               | Description            | Mat   | Dimension   | Cutting Size        | Typepology                  | Skin |
|-----|---------------------------|------------------------|-------|-------------|---------------------|-----------------------------|------|
| 0   | 1PLUS_LIFE2_TOP_103L      |                        |       | 1402x38x600 |                     |                             |      |
|     | 1PLUS_LIFE2_TOP_103L-01A  | TOP ASSEMBLE COMPLETED | PB-   | 38x600x1402 | 38X600X1400.4;L0:W2 | 182000_STR=04.26_EDG=HPL-.8 | 2    |
|     | 1PLUS_LIFE2_TOP_103L-01AA | TOP                    | PB-ST | 18x600x1412 | 18X600X1412;NO EDGE | 182001_STR=04.10_EDG=-      | 1    |
|     | 1PLUS_LIFE2_TOP_103L-01AB | DOUBLE TOP             | PB-ST | 18x50x1412  | 18X50X1412;NO EDGE  | 182002_STR=30.02_EDG=-      |      |
|     | 1PLUS_LIFE2_TOP_103L-01B  | DOUBLE FRONT BACK      | PB-ST | 18x50x1192  | 18X50X1192;NO EDGE  | 182003_STR=30.01_EDG=-      | 2    |
|     | 1PLUS_LIFE2_TOP_103L-01B  | DOUBLE FRONT BACK      | PB-ST | 18x50x1192  | 18X50X1192;NO EDGE  | 182004_STR=30.01_EDG=-      | 2    |
|     | 1PLUS_LIFE2_TOP_103L-01C  | DOUBLE LIFE RIGHT      | PB-ST | 18x110x550  | 18X110X550;NO EDGE  | 185000_STR=30.01_EDG=-      | 2    |
|     | 1PLUS_LIFE2_TOP_103L-01C  | DOUBLE LIFE RIGHT      | PB-ST | 18x110x550  | 18X110X550;NO EDGE  | 185001_STR=30.01_EDG=-      | 2    |

|                 |                    |                  |                    |
|-----------------|--------------------|------------------|--------------------|
| <b>Model</b>    | 1PLUS_LIFE2_DBH602 |                  |                    |
| <b>Creator</b>  | CHALEAMPHON        | <b>.BCP Name</b> | INDEX_C3D_KITCHEN2 |
| <b>Reviewer</b> |                    | <b>Order</b>     | H002348            |
| <b>Approves</b> |                    | <b>Date</b>      | 12/02/2026         |

## 1PLUS\_LIFE2\_DBH602-600X570X760

**Colour**

20.01=ML.MFI599\_PEARL  
05.87=ML.HOKAIDO ELM#AV4 (MATT WOODGRAIN)

**Edge**

01.464=0.6 MFI599 PEARL(111038M1)  
01.481=0.6 ML.HOKAIDO ELM AV4  
01.382=1 AV4

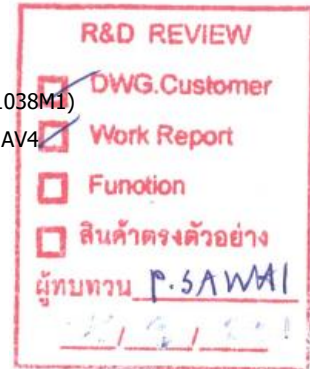

- K100R-160177012
- K101R-160177022
- K103L-160177042
- K103R-160177052
- K104R-160177062
- K102R-1601



|                 |             |                  |                    |
|-----------------|-------------|------------------|--------------------|
| <b>Model</b>    | -           |                  |                    |
| <b>Creator</b>  | CHALEAMPHON | <b>.BCP Name</b> | INDEX_C3D_KITCHEN2 |
| <b>Reviewer</b> |             | <b>Order</b>     | H002348            |
| <b>Approves</b> |             | <b>Date</b>      | 12/02/2026         |

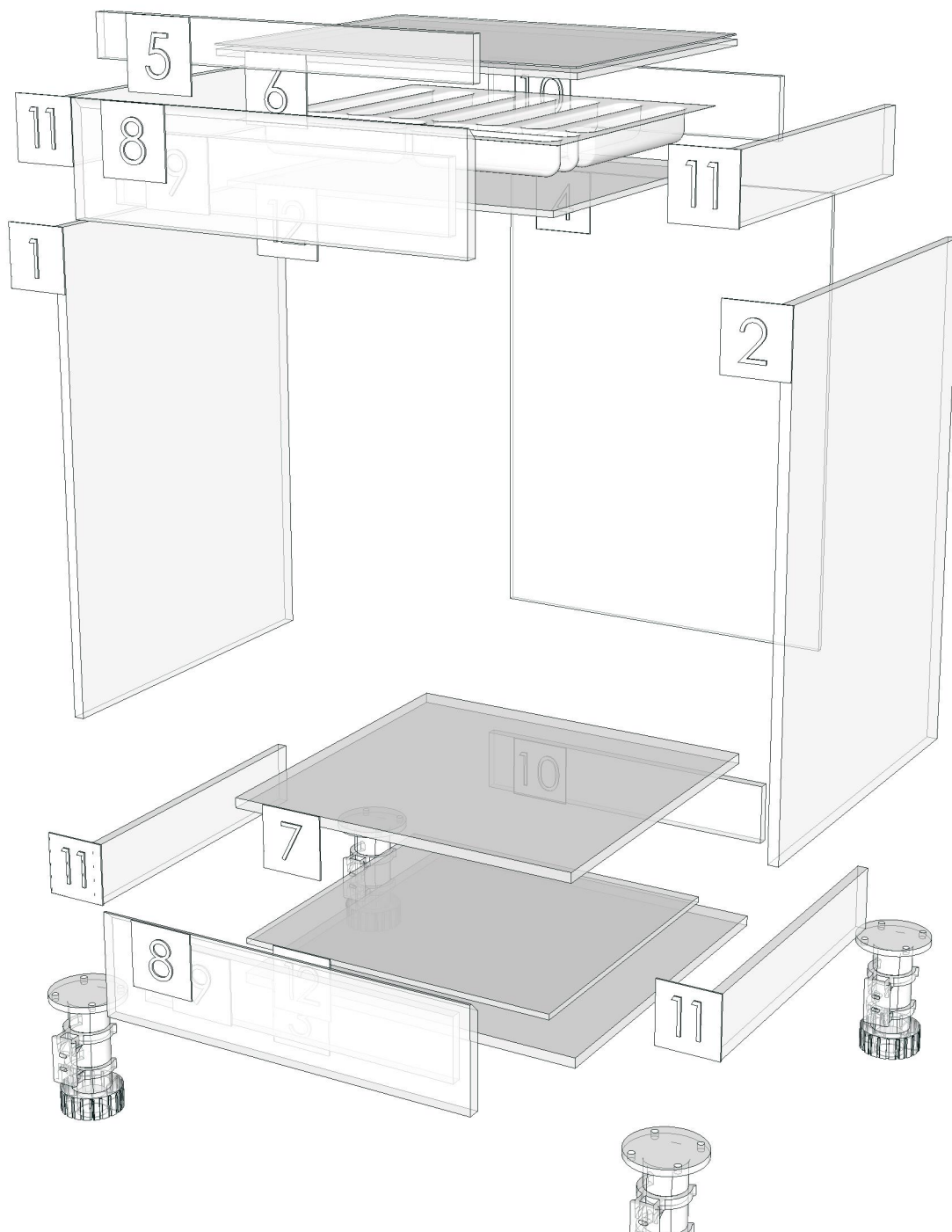

|                 |                   |                  |                    |
|-----------------|-------------------|------------------|--------------------|
| <b>Model</b>    | 1PLUS_LIFE2_DBS70 |                  |                    |
| <b>Creator</b>  | CHALEAMPHON       | <b>.BCP Name</b> | INDEX_C3D_KITCHEN2 |
| <b>Reviewer</b> |                   | <b>Order</b>     | H002367            |
| <b>Approves</b> |                   | <b>Date</b>      | 16/02/2026         |

## 1PLUS\_LIFE2\_DBS70-700X570X760

**Colour**

20.01=ML.MFI599\_PEARL  
05.87=ML.HOKAIDO ELM#AV4 (MATT WOODGRAIN)

**Edge**

01.464=0.6 MFI599 PEARL(111038M1)  
01.481=0.6 ML.HOKAIDO ELM AV4  
01.382=1 AV4

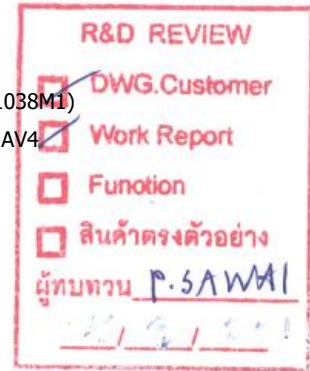

K101R-160177022  
K103L-160177042  
K103R-160177052

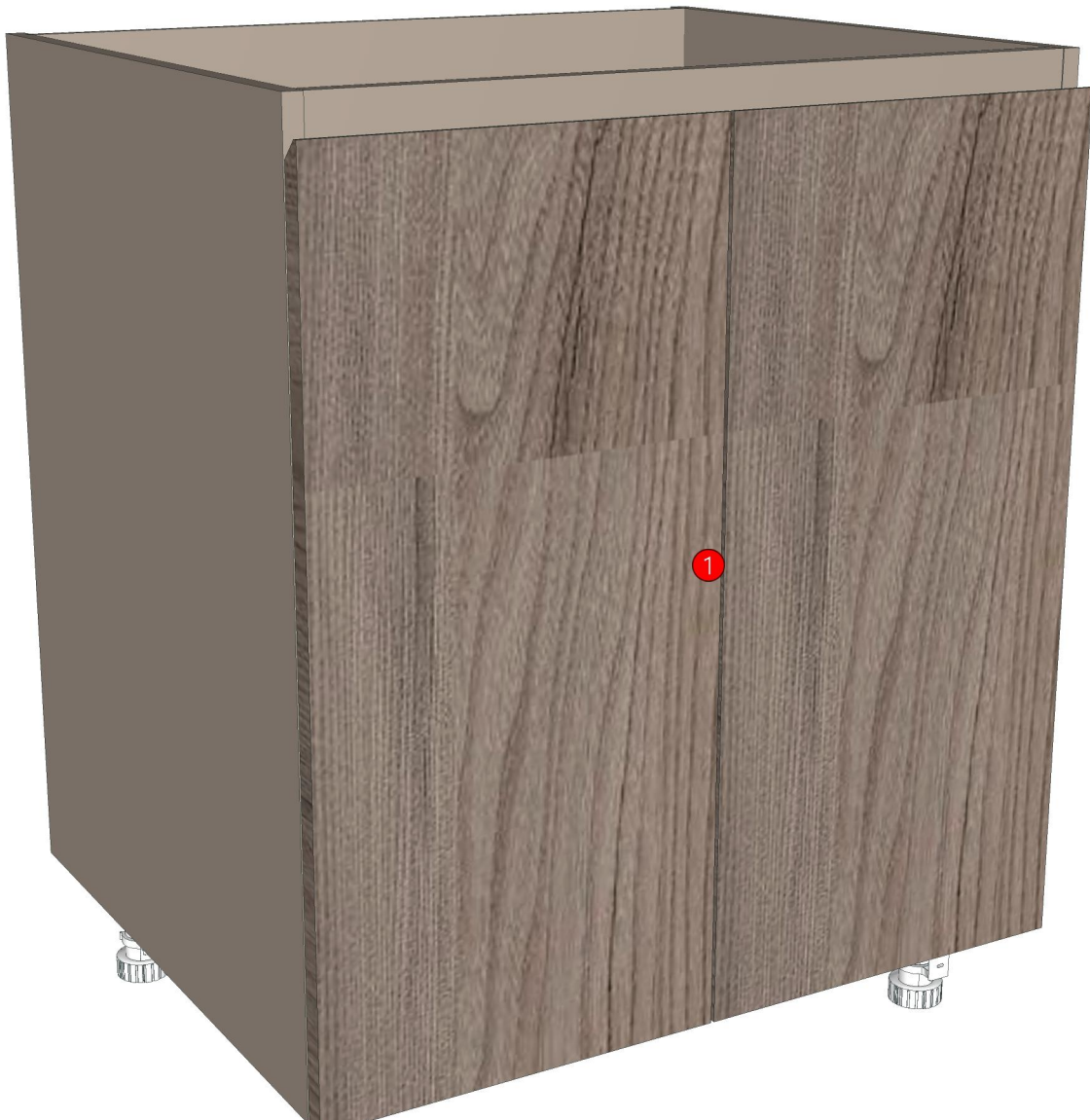

|                 |             |                  |                    |
|-----------------|-------------|------------------|--------------------|
| <b>Model</b>    | -           |                  |                    |
| <b>Creator</b>  | CHALEAMPHON | <b>.BCP Name</b> | INDEX_C3D_KITCHEN2 |
| <b>Reviewer</b> |             | <b>Order</b>     | H002367            |
| <b>Approves</b> |             | <b>Date</b>      | 16/02/2026         |

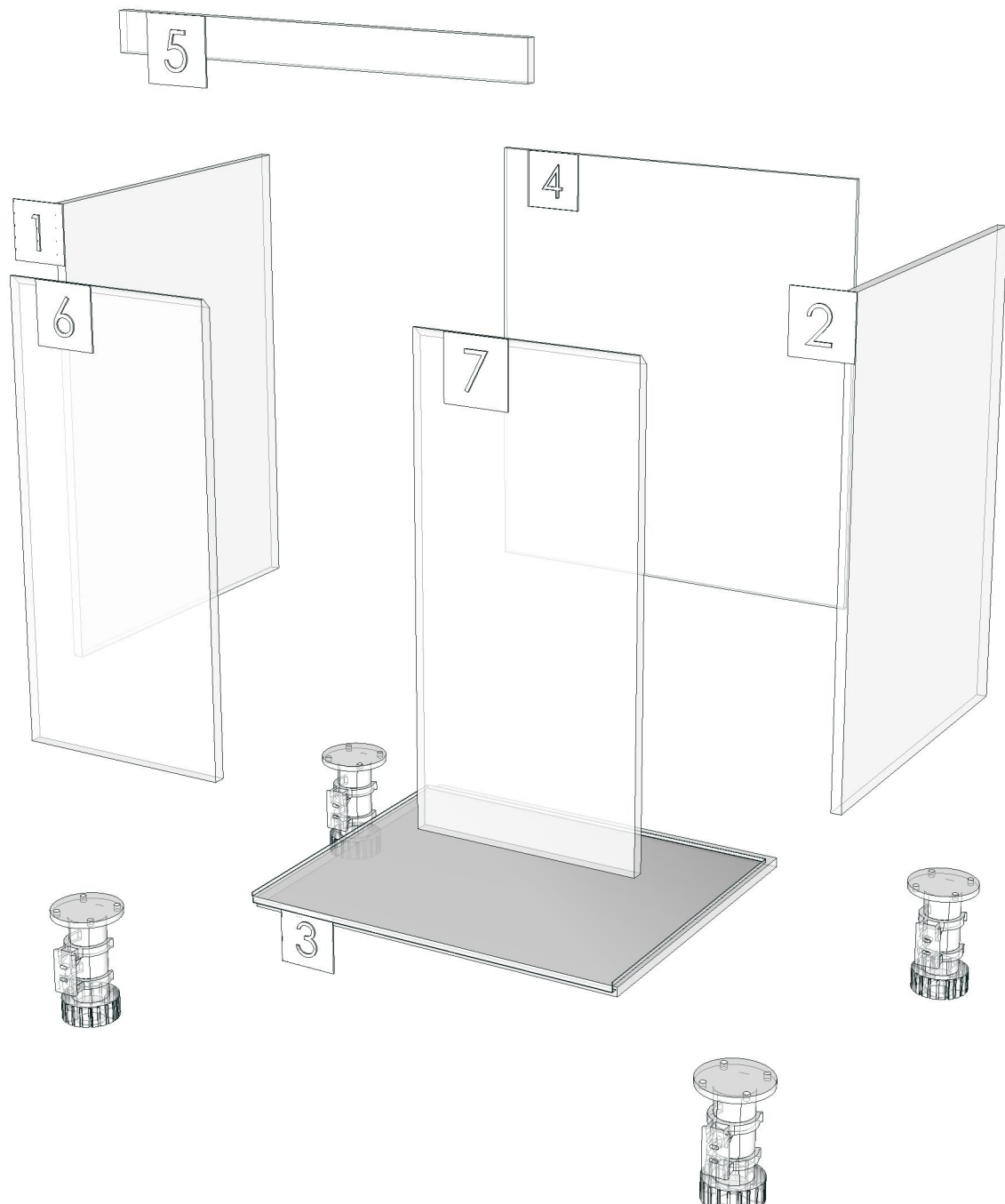

|                 |                |                  |                    |
|-----------------|----------------|------------------|--------------------|
| <b>Model</b>    | 1PLUS_L2_DDM70 |                  |                    |
| <b>Creator</b>  | CHALEAMPON     | <b>.BCP Name</b> | INDEX_C3D_KITCHEN2 |
| <b>Reviewer</b> |                | <b>Order</b>     | H002350            |
| <b>Approves</b> |                | <b>Date</b>      | 13/02/2026         |

## **1PLUS\_L2\_DDM70-700X16X200**

**Colour**

20.01=ML.MFI599\_PEARL

**Edge**

01.464=0.6 MFI599 PEARL(111038M1)

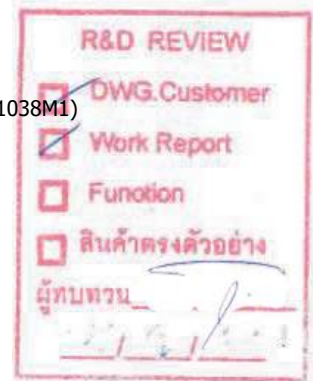

K101R-160177022

K103L-160177042

K103R-160177052

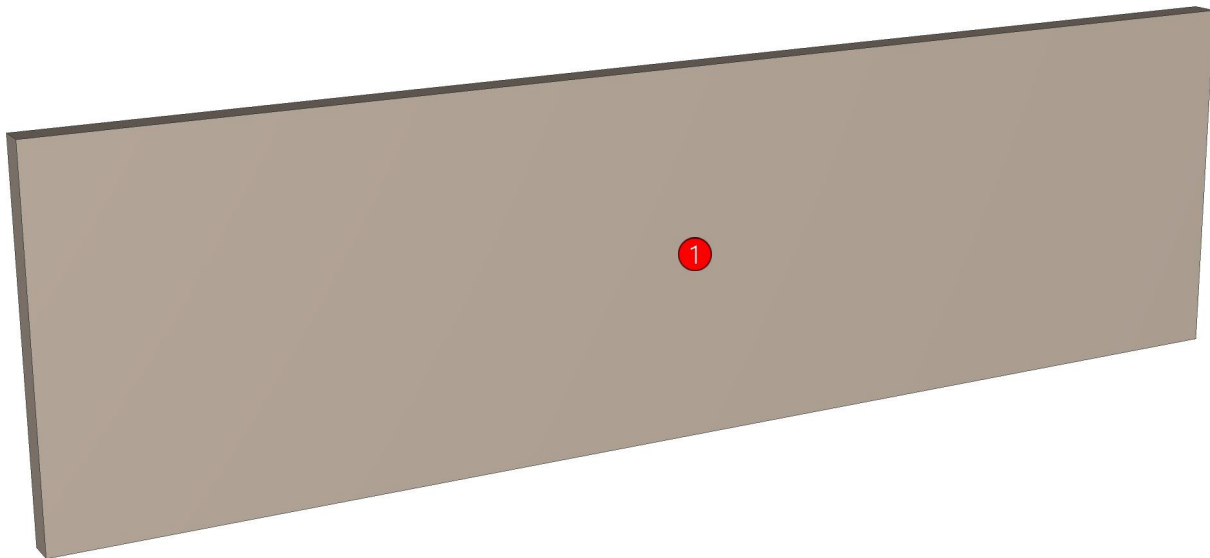

|                 |                |                  |                    |
|-----------------|----------------|------------------|--------------------|
| <b>Model</b>    | 1PLUS_L2_DDM70 |                  |                    |
| <b>Creator</b>  | CHALEAMPON     | <b>.BCP Name</b> | INDEX_C3D_KITCHEN2 |
| <b>Reviewer</b> |                | <b>Order</b>     | H002350            |
| <b>Approves</b> |                | <b>Date</b>      | 13/02/2026         |

| No. | Article No.       | Description | Mat   | Dimension  | Cutting Size         | Typepology                           | Skin |
|-----|-------------------|-------------|-------|------------|----------------------|--------------------------------------|------|
| 0   | 1PLUS_L2_DDM70    |             |       | 700x200x16 |                      |                                      |      |
|     | 1PLUS_L2_DDM70-01 | WALL MOUNT  | PB-ST | 16x200x700 | 16X198.8X698.8;L2:W2 | 183000_STR=20.01_EDG=MFI599 PEARL-.6 | 2    |

|                 |                 |                  |                    |
|-----------------|-----------------|------------------|--------------------|
| <b>Model</b>    | 1PLUS_LIFE2_DFB |                  |                    |
| <b>Creator</b>  | CHALEAMPON      | <b>.BCP Name</b> | INDEX_C3D_KITCHEN2 |
| <b>Reviewer</b> |                 | <b>Order</b>     | H002356            |
| <b>Approves</b> |                 | <b>Date</b>      | 13/02/2026         |

## **1PLUS\_LIFE2\_DFB-150X570X760**

**Colour**

20.01=ML.MFI599\_PEARL

**Edge**

01.464=0.6 MFI599 PEARL(111038M1)

|                                     |                   |
|-------------------------------------|-------------------|
| <b>R&amp;D REVIEW</b>               |                   |
| <input checked="" type="checkbox"/> | DWG.Customer      |
| <input checked="" type="checkbox"/> | Work Report       |
| <input type="checkbox"/>            | Function          |
| <input type="checkbox"/>            | สินค้าตรงตัวอย่าง |
| ผู้ทบทวน <u>P.SAWAI</u>             |                   |
| <u>22/2/26</u>                      |                   |

K103L-160177042

K103R-160177052

K102R-1601

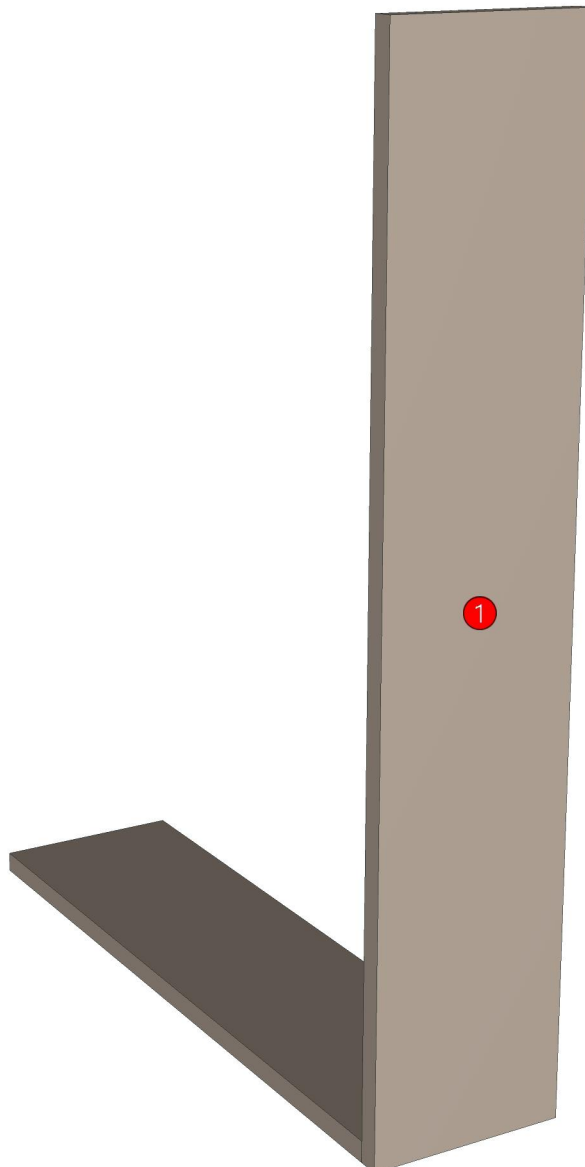

|                 |            |                  |                    |
|-----------------|------------|------------------|--------------------|
| <b>Model</b>    | -          |                  |                    |
| <b>Creator</b>  | CHALEAMPON | <b>.BCP Name</b> | INDEX_C3D_KITCHEN2 |
| <b>Reviewer</b> |            | <b>Order</b>     | H002356            |
| <b>Approves</b> |            | <b>Date</b>      | 13/02/2026         |

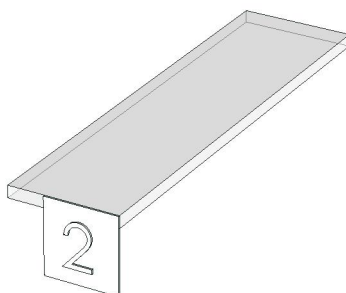
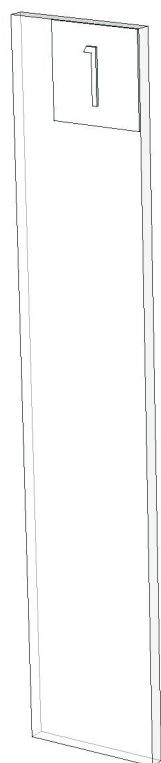

|                 |                 |                  |                    |
|-----------------|-----------------|------------------|--------------------|
| <b>Model</b>    | 1PLUS_LIFE2_DFL |                  |                    |
| <b>Creator</b>  | CHALEAMPON      | <b>.BCP Name</b> | INDEX_C3D_KITCHEN2 |
| <b>Reviewer</b> |                 | <b>Order</b>     | H002357            |
| <b>Approves</b> |                 | <b>Date</b>      | 13/02/2026         |

## **1PLUS\_LIFE2\_DFL-150X300X600**

**Colour**

20.01=ML.MFI599\_PEARL

**Edge**

01.464=0.6 MFI599 PEARL(111038M1)

|                                     |                   |
|-------------------------------------|-------------------|
| <b>R&amp;D REVIEW</b>               |                   |
| <input checked="" type="checkbox"/> | DWG.Customer      |
| <input checked="" type="checkbox"/> | Work Report       |
| <input type="checkbox"/>            | Function          |
| <input type="checkbox"/>            | สินค้าตรงตัวอย่าง |
| ผู้ทบทวน <u>P.SAWAI</u>             |                   |
| <u>22/2/26</u>                      |                   |

K103L-160177042

K103R-160177052

K102R-1601

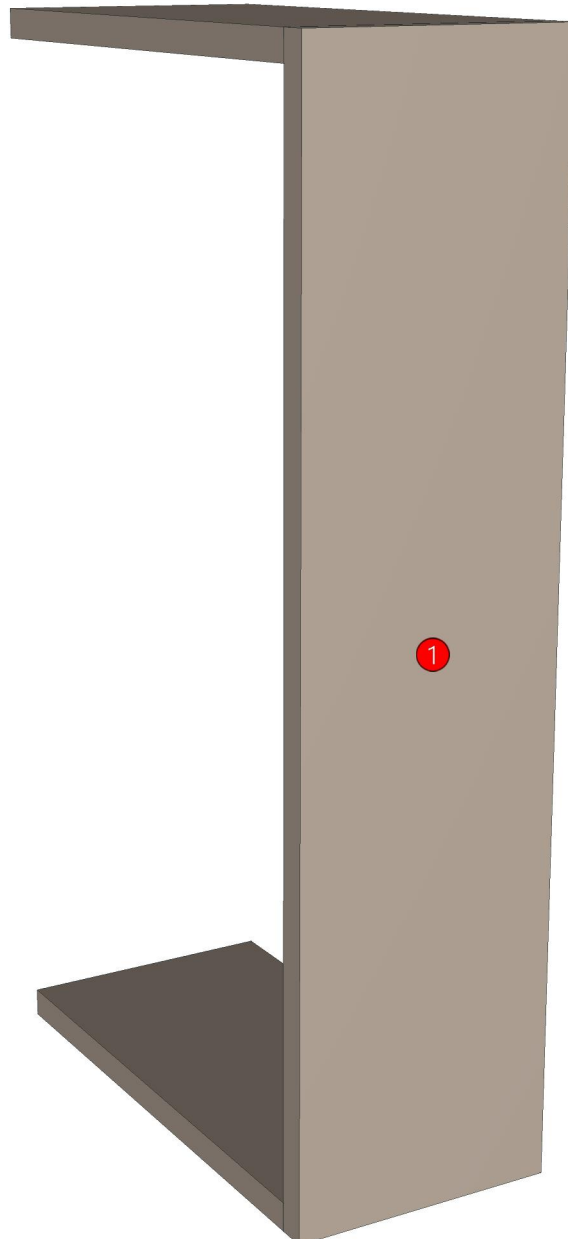

|                 |            |                  |                    |
|-----------------|------------|------------------|--------------------|
| <b>Model</b>    | -          |                  |                    |
| <b>Creator</b>  | CHALEAMPON | <b>.BCP Name</b> | INDEX_C3D_KITCHEN2 |
| <b>Reviewer</b> |            | <b>Order</b>     | H002357            |
| <b>Approves</b> |            | <b>Date</b>      | 13/02/2026         |

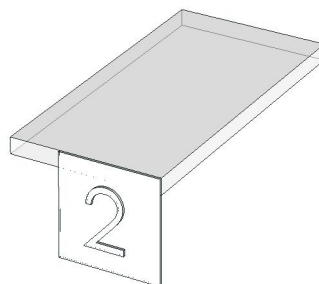
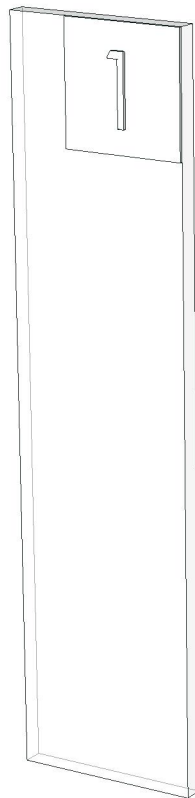
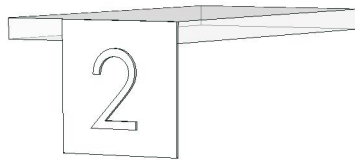

|                 |                      |                  |                    |
|-----------------|----------------------|------------------|--------------------|
| <b>Model</b>    | 1PLUS_LIFE2_DL60(H)R |                  |                    |
| <b>Creator</b>  | CHALEAMPHON          | <b>.BCP Name</b> | INDEX_C3D_KITCHEN2 |
| <b>Reviewer</b> |                      | <b>Order</b>     | H002361            |
| <b>Approves</b> |                      | <b>Date</b>      | 13/02/2026         |

## **1PLUS\_LIFE2\_DL60(H)R-600X300X555**

**Colour**

20.01=ML.MFI599\_PEARL

05.87=ML.HOKAIDO ELM#AV4 (MATT WOODGRAIN)

**Edge**

01.464=0.6 MFI599 PEARL(111038M1)

01.481=0.6 ML.HOKAIDO ELM AV4

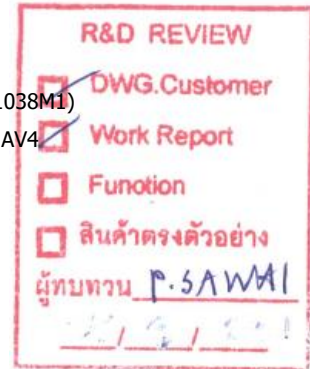

K103L-160177042



|                 |             |                  |                    |
|-----------------|-------------|------------------|--------------------|
| <b>Model</b>    | -           |                  |                    |
| <b>Creator</b>  | CHALEAMPHON | <b>.BCP Name</b> | INDEX_C3D_KITCHEN2 |
| <b>Reviewer</b> |             | <b>Order</b>     | H002361            |
| <b>Approves</b> |             | <b>Date</b>      | 13/02/2026         |

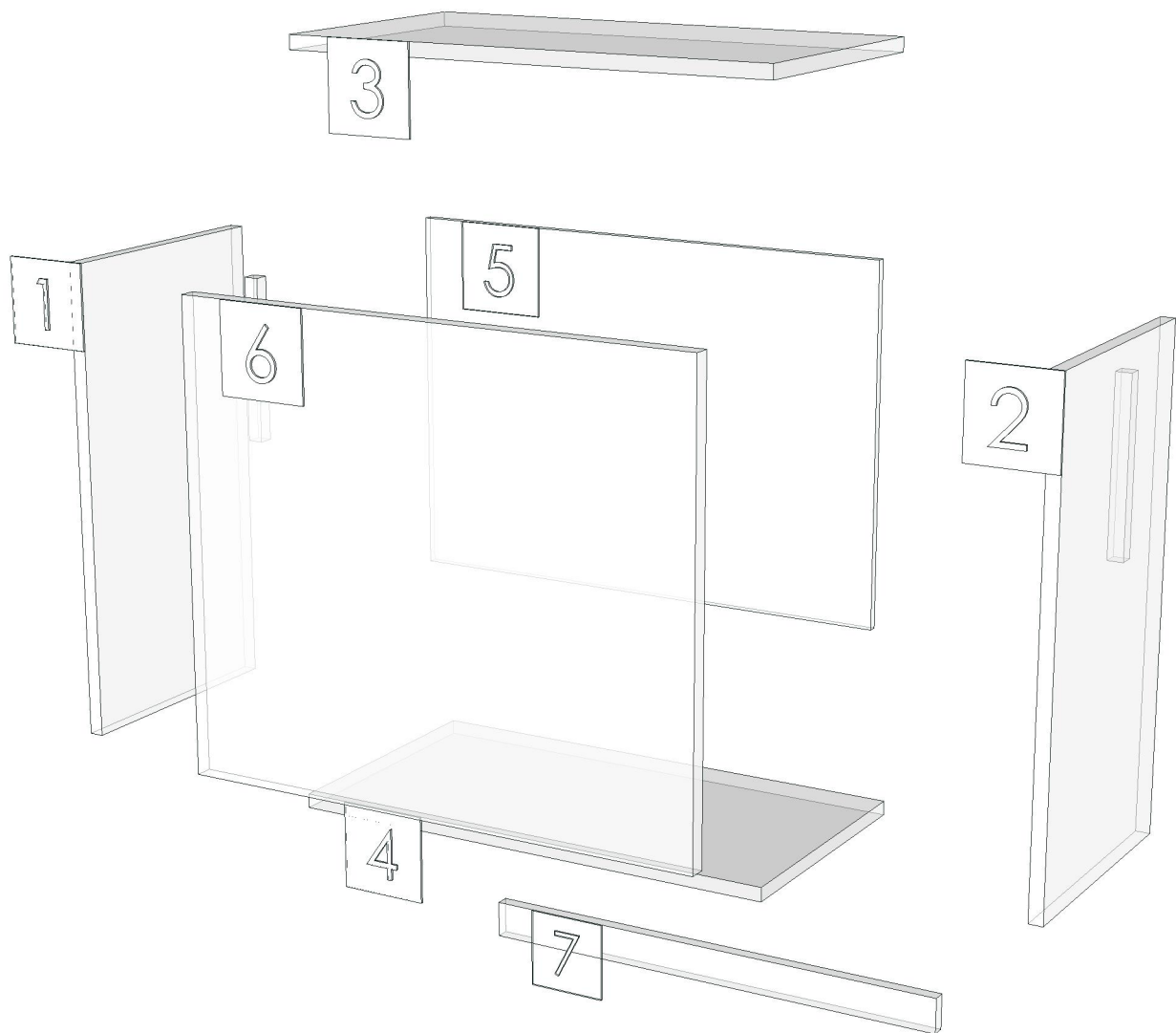

|                 |                       |                  |                    |
|-----------------|-----------------------|------------------|--------------------|
| <b>Model</b>    | 1PLUS_LIFE2_DPLT_1400 |                  |                    |
| <b>Creator</b>  | CHALEAMPON            | <b>.BCP Name</b> | INDEX_C3D_KITCHEN2 |
| <b>Reviewer</b> |                       | <b>Order</b>     | H002372            |
| <b>Approves</b> |                       | <b>Date</b>      | 17/02/2026         |

## **1PLUS\_LIFE2\_DPLT\_1400-1400X12X100**

Colour

Edge

-

-

|                                     |                   |
|-------------------------------------|-------------------|
| <b>R&amp;D REVIEW</b>               |                   |
| <input checked="" type="checkbox"/> | DWG.Customer      |
| <input checked="" type="checkbox"/> | Work Report       |
| <input type="checkbox"/>            | Function          |
| <input type="checkbox"/>            | สินค้าตรงตัวอย่าง |
| ผู้ทบทวน <u>P.SAWAI</u>             |                   |
| <u>22/2/2026</u>                    |                   |

K103L-160177042

K103R-160177052

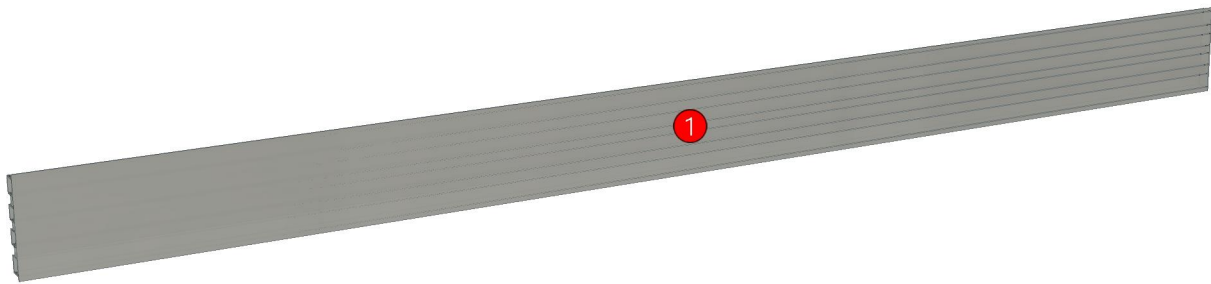

|                 |                       |                  |                    |
|-----------------|-----------------------|------------------|--------------------|
| <b>Model</b>    | 1PLUS_LIFE2_DPLT_1400 |                  |                    |
| <b>Creator</b>  | CHALEAMPHON           | <b>.BCP Name</b> | INDEX_C3D_KITCHEN2 |
| <b>Reviewer</b> |                       | <b>Order</b>     | H002372            |
| <b>Approves</b> |                       | <b>Date</b>      | 17/02/2026         |

| No. | Article No.           | Description | Mat | Dimension   | Cutting Size | Typepology | Skin |
|-----|-----------------------|-------------|-----|-------------|--------------|------------|------|
| 0   | 1PLUS_LIFE2_DPLT_1400 |             |     | 1400x100x12 |              |            |      |

|                 |                      |                  |                    |
|-----------------|----------------------|------------------|--------------------|
| <b>Model</b>    | 1PLUS_LIFE2_DPLT_600 |                  |                    |
| <b>Creator</b>  | CHALEAMPON           | <b>.BCP Name</b> | INDEX_C3D_KITCHEN2 |
| <b>Reviewer</b> |                      | <b>Order</b>     | H002376            |
| <b>Approves</b> |                      | <b>Date</b>      | 17/02/2026         |

## **1PLUS\_LIFE2\_DPLT\_600-600X12X100**

Colour

Edge

-

-



- K100R-160177012
- K101R-160177022
- K103L-160177042
- K103R-160177052
- K104R-160177062
- K105R-160177073
- K102R-1601

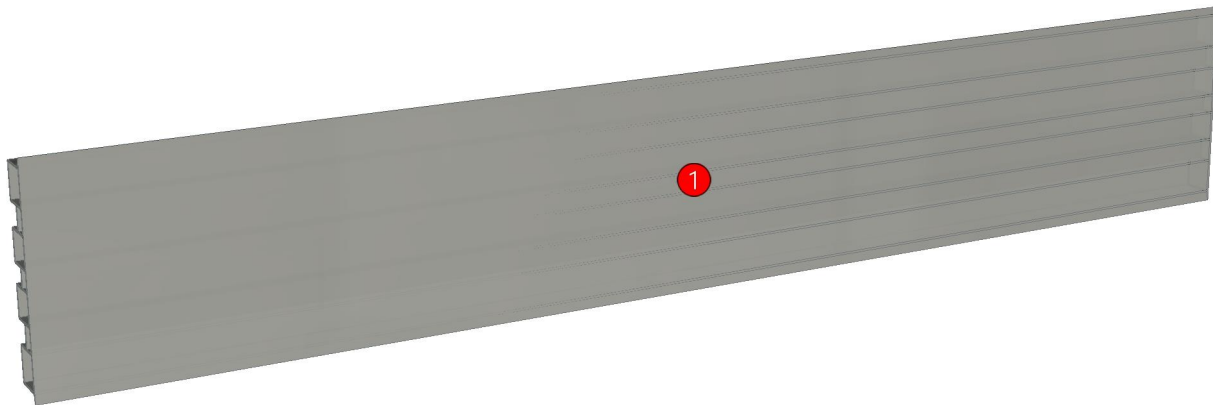

|                 |                      |                  |                    |
|-----------------|----------------------|------------------|--------------------|
| <b>Model</b>    | 1PLUS_LIFE2_DPLT_600 |                  |                    |
| <b>Creator</b>  | CHALEAMPHON          | <b>.BCP Name</b> | INDEX_C3D_KITCHEN2 |
| <b>Reviewer</b> |                      | <b>Order</b>     | H002376            |
| <b>Approves</b> |                      | <b>Date</b>      | 17/02/2026         |

| No. | Article No.          | Description | Mat | Dimension  | Cutting Size | Typepology | Skin |
|-----|----------------------|-------------|-----|------------|--------------|------------|------|
| 0   | 1PLUS_LIFE2_DPLT_600 |             |     | 600x100x12 |              |            |      |

|                 |                   |                  |                    |
|-----------------|-------------------|------------------|--------------------|
| <b>Model</b>    | 1PLUS_LIFE2_DSH70 |                  |                    |
| <b>Creator</b>  | CHALEAMPON        | <b>.BCP Name</b> | INDEX_C3D_KITCHEN2 |
| <b>Reviewer</b> |                   | <b>Order</b>     | H002353            |
| <b>Approves</b> |                   | <b>Date</b>      | 13/02/2026         |

## **1PLUS\_LIFE2\_DSH70-700X284X19**

**Colour**

05.87=ML.HOKAIDO ELM#AV4 (MATT WOODGRAIN)

**Edge**

01.481=0.6 ML.HOKAIDO ELM AV4

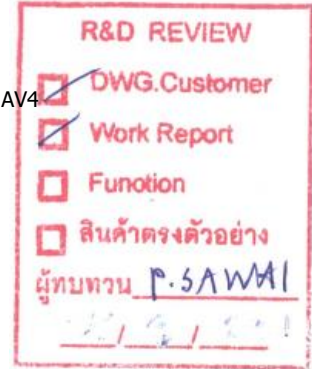

K101R-160177022

K103L-160177042

K103R-160177052

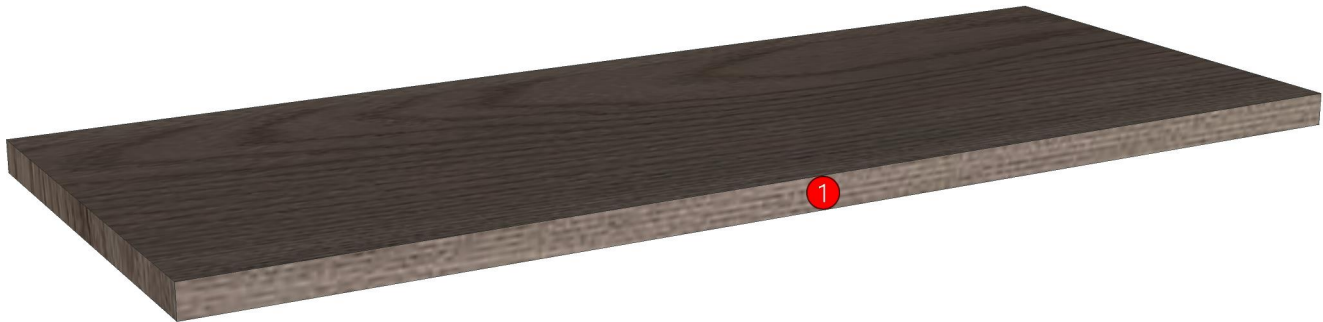

|                 |                   |                  |                    |
|-----------------|-------------------|------------------|--------------------|
| <b>Model</b>    | 1PLUS_LIFE2_DSH70 |                  |                    |
| <b>Creator</b>  | CHALEAMPON        | <b>.BCP Name</b> | INDEX_C3D_KITCHEN2 |
| <b>Reviewer</b> |                   | <b>Order</b>     | H002353            |
| <b>Approves</b> |                   | <b>Date</b>      | 13/02/2026         |

| No. | Article No.          | Description | Mat   | Dimension  | Cutting Size         | Typepology                  | Skin |
|-----|----------------------|-------------|-------|------------|----------------------|-----------------------------|------|
| 0   | 1PLUS_LIFE2_DSH70    |             |       | 700x19x284 |                      |                             |      |
|     | 1PLUS_LIFE2_DSH70-01 | SHELF       | PB-ST | 19x284x700 | 19X283.4X698.8;L1:W2 | 182000_STR=05.87_EDG=AV4-.6 | 2    |

|                 |                     |                  |                    |
|-----------------|---------------------|------------------|--------------------|
| <b>Model</b>    | 1PLUS_LIFE2_DW70(S) |                  |                    |
| <b>Creator</b>  | CHALEAMPHON         | <b>.BCP Name</b> | INDEX_C3D_KITCHEN2 |
| <b>Reviewer</b> |                     | <b>Order</b>     | H002362            |
| <b>Approves</b> |                     | <b>Date</b>      | 13/02/2026         |

## **1PLUS\_LIFE2\_DW70(S)-700X300X400**

**Colour**

20.01=ML.MFI599\_PEARL

05.87=ML.HOKAIDO ELM#AV4 (MATT WOODGRAIN)

**Edge**

01.464=0.6 MFI599 PEARL(111038M1)

01.481=0.6 ML.HOKAIDO ELM AV4

01.382=1 AV4

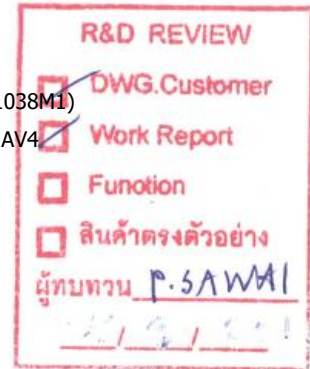

K101R-160177022

K103L-160177042

K103R-160177052



|                 |             |                  |                    |
|-----------------|-------------|------------------|--------------------|
| <b>Model</b>    | -           |                  |                    |
| <b>Creator</b>  | CHALEAMPHON | <b>.BCP Name</b> | INDEX_C3D_KITCHEN2 |
| <b>Reviewer</b> |             | <b>Order</b>     | H002362            |
| <b>Approves</b> |             | <b>Date</b>      | 13/02/2026         |

