

Model	ESCENT_BNA_DB20LGRSR		
Creator	SUTTHI.P	.BCP Name	INDEX_C3D_KITCHENPAE
Reviewer		Order	O003047
Approves	<i>P.SAWA</i>	Date	23/01/2026

ESCENT_BNA_DB20LGRSR-200X570X772

Colour

05.01=ML WHITE VM1012 18/18
05.72=ML.MD645 LONG BEACH (SN)

Edge

01.24=0.6 WHITE
01.392=1 LONG BEACH-MD645 (MW40-A1059TH00)

K1R 160175432

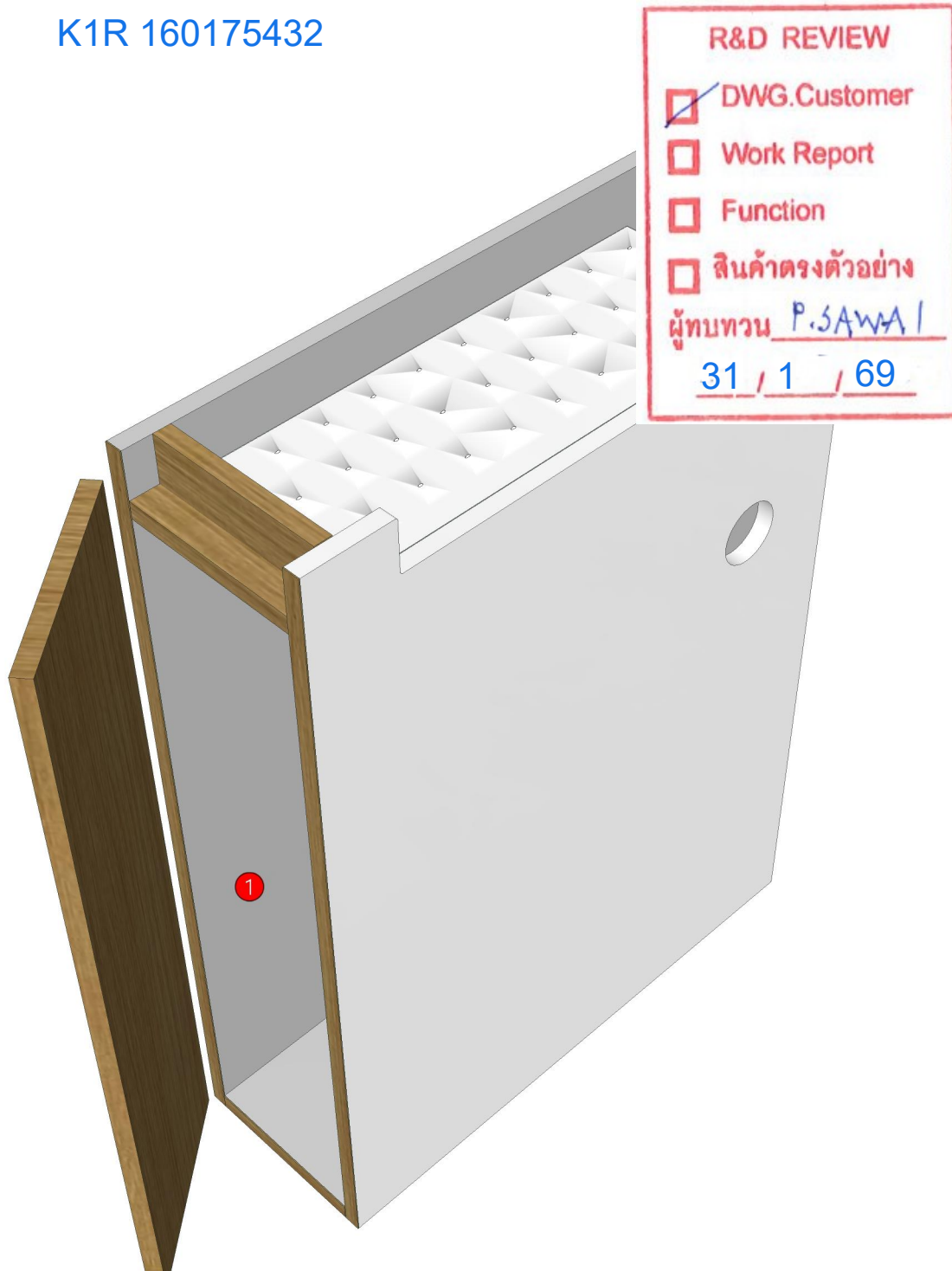

Model	-ESCENT_BNA_DB20LGRSR		
Creator	SUTTHI.P	.BCP Name	INDEX_C3D_KITCHENPAE
Reviewer		Order	0003047
Approves	<i>P. SAWA</i>	Date	23/01/2026

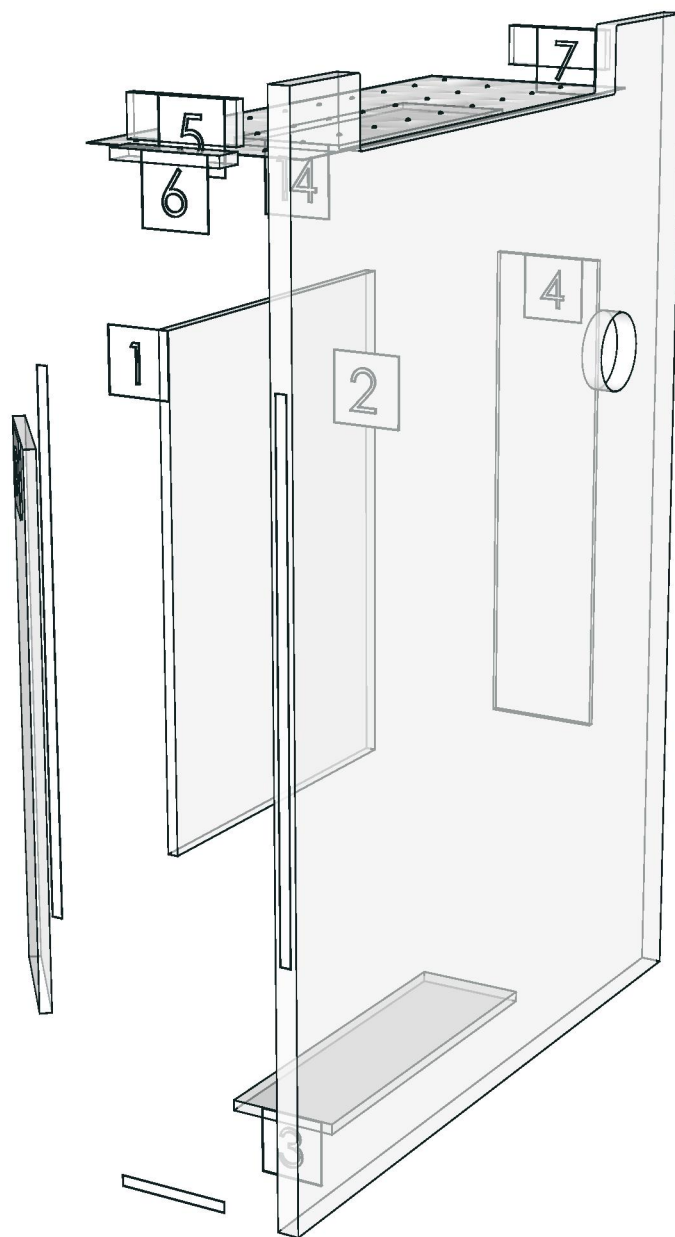

Model	ESCENT_BNA_DBS50RGL_		
Creator	SUTTHI.P	.BCP Name	INDEX_C3D_KITCHENPAE
Reviewer		Order	O003049
Approves		Date	01/04/2026

ESCENT_BNA_DBS50RGL_-500X570X772

Colour

05.01=ML WHITE VM1012 18/18

05.72=ML.MD645 LONG BEACH (SN)

Edge

01.24=0.6 WHITE

01.392=1 LONG BEACH-MD645 (MW40-A1059TH00)

K1R_160175432

K2R_160175441

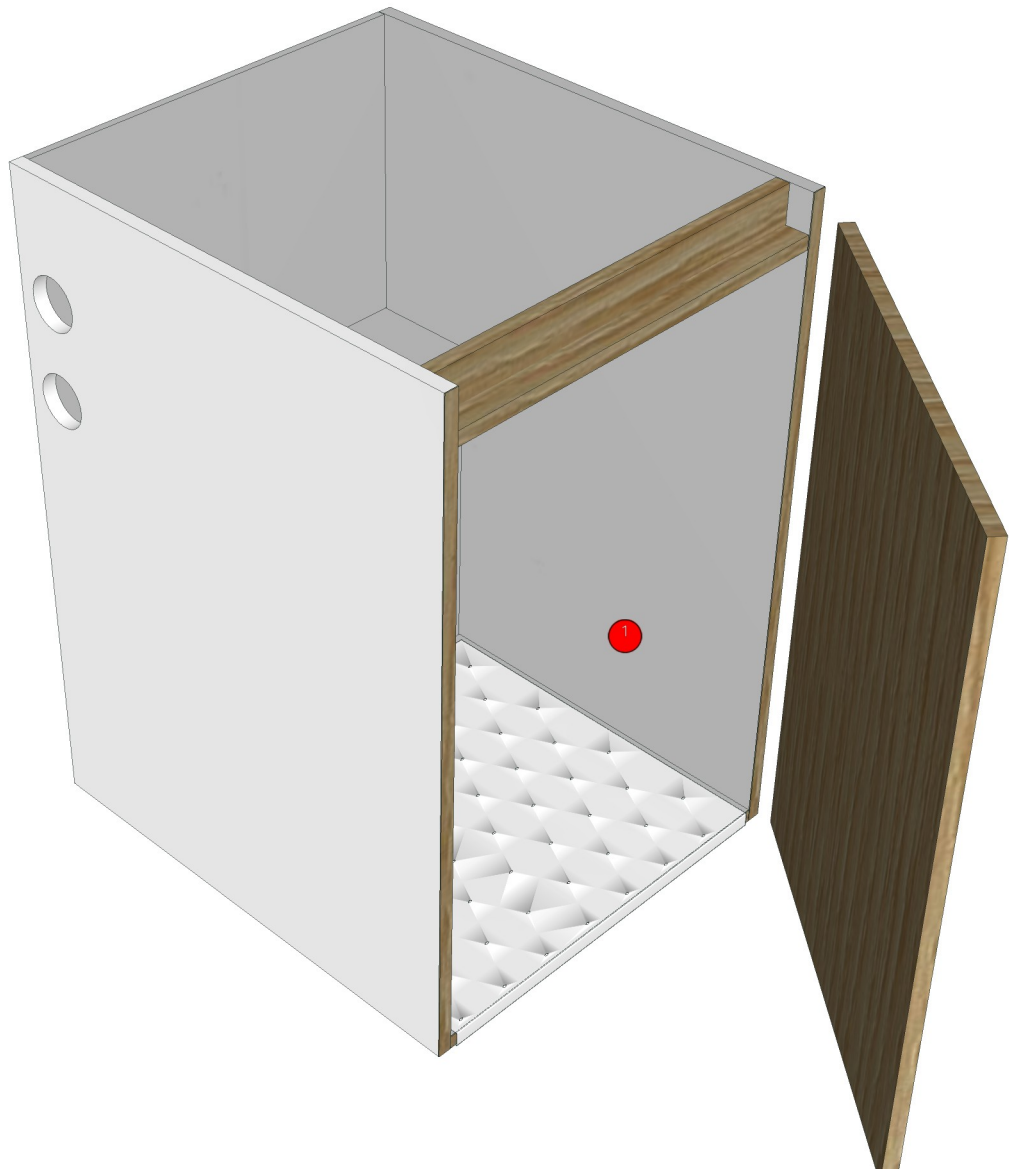

Model	-ESCENT_BNA_DBS50RGL_		
Creator		.BCP Name	INDEX_C3D_KITCHENPAE
Reviewer		Order	I003049
Approves		Date	

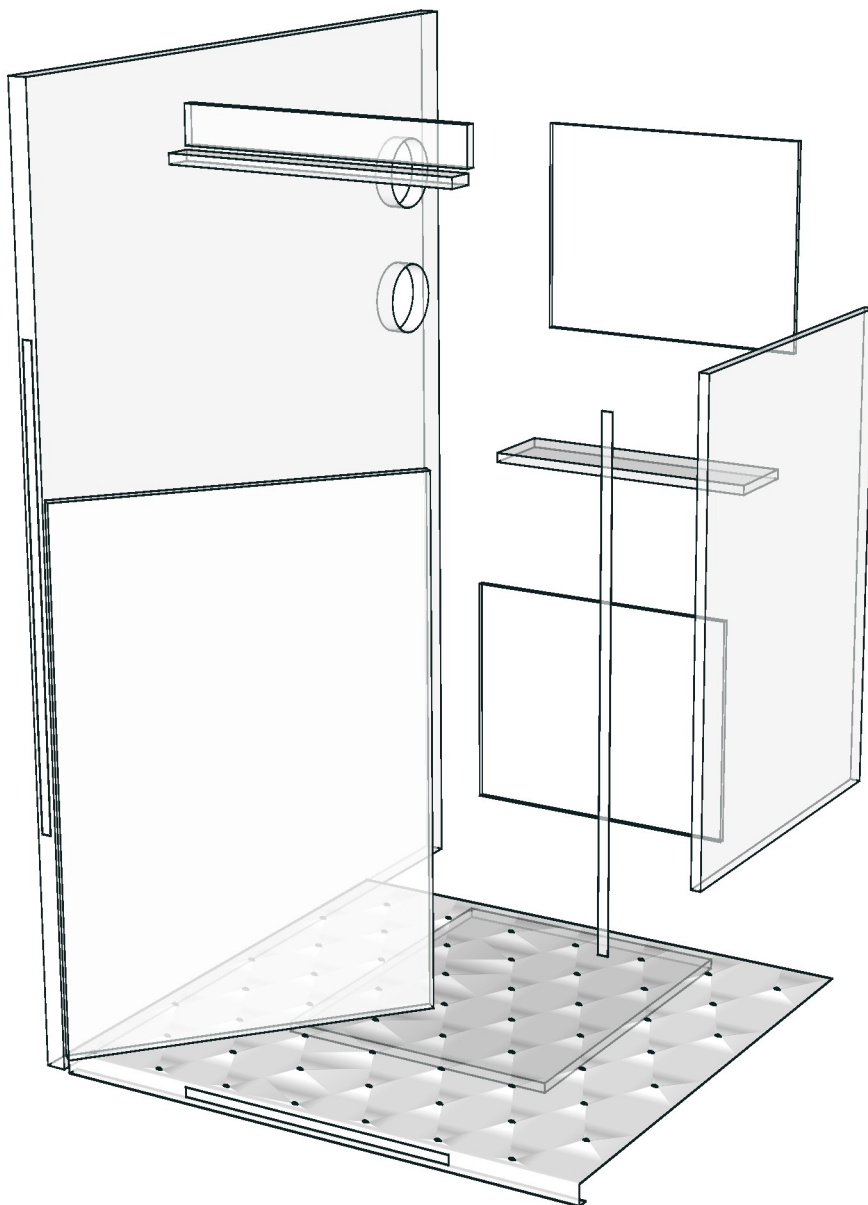

Model	ESCENT_BNA_DEPB_		
Creator	SUTTHI.P	.BCP Name	INDEX_C3D_KITCHENPAE
Reviewer		Order	O003074
Approves		Date	01/04/2026

ESCENT_BNA_DEPB_-590X16X772

Colour

05.01=ML WHITE VM1012 18/18

05.72=ML.MD645 LONG BEACH (SN)

Edge

01.24=0.6 WHITE

01.392=1 LONG BEACH-MD645 (MW40-A1059TH00)

K1R_160175432

K2R_160175441

K3L_160175451

K1L_160177227

K2L_160177236

K3R_160177246

K15R_160178565

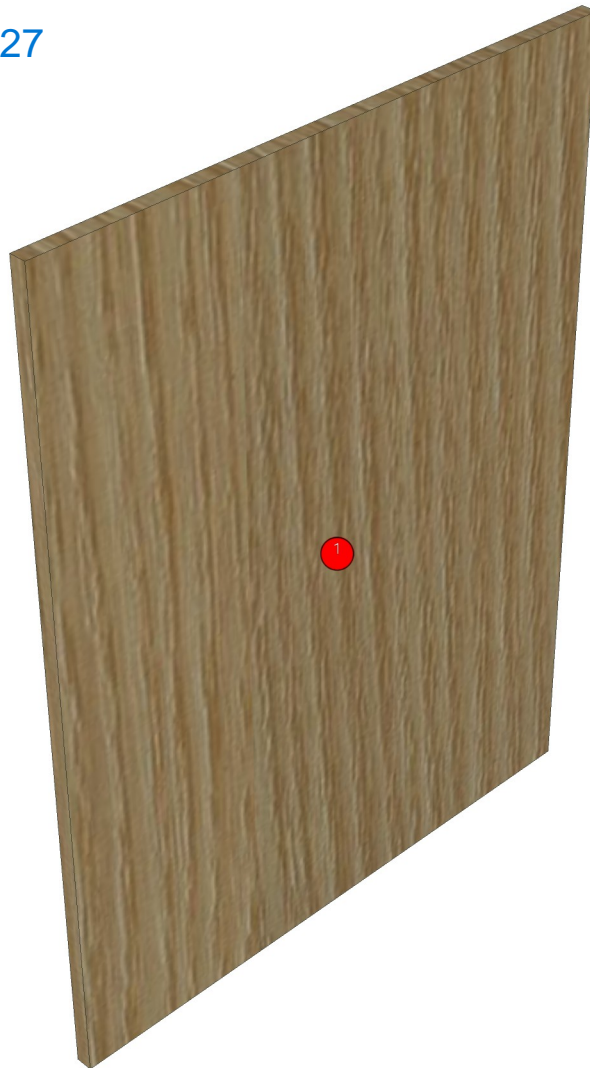

Model	-ESCENT_BNA_DEPB_		
Creator		.BCP Name	INDEX_C3D_KITCHENPAE
Reviewer		Order	I003074
Approves		Date	

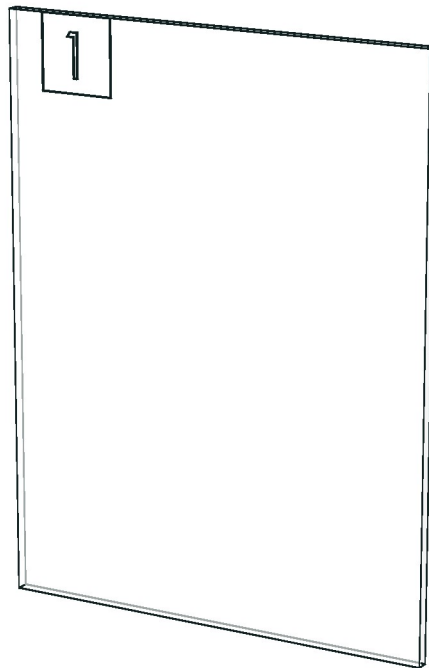

Model	ESCENT_BNA_DFB_		
Creator	SUTTHI.P	.BCP Name	INDEX_C3D_KITCHENPAE
Reviewer		Order	O003075
Approves		Date	01/04/2026

ESCENT_BNA_DFB_-150X570X772

Colour

05.01=ML WHITE VM1012 18/18
05.72=ML.MD645 LONG BEACH (SN)

Edge

01.24=0.6 WHITE
01.392=1 LONG BEACH-MD645 (MW40-A1059TH00)

K1R_160175432
K2R_160175441
K3L_160175451

K1L_160177227
K2L_160177236
K3R160177246

K15R_160178565



R&D REVIEW	
<input checked="" type="checkbox"/>	DWG.Customer
<input type="checkbox"/>	Work Report
<input checked="" type="checkbox"/>	Function
<input type="checkbox"/>	สินค้าตรงตัวอย่าง
ผู้ทบทวน 	
9 / 5 / 29	

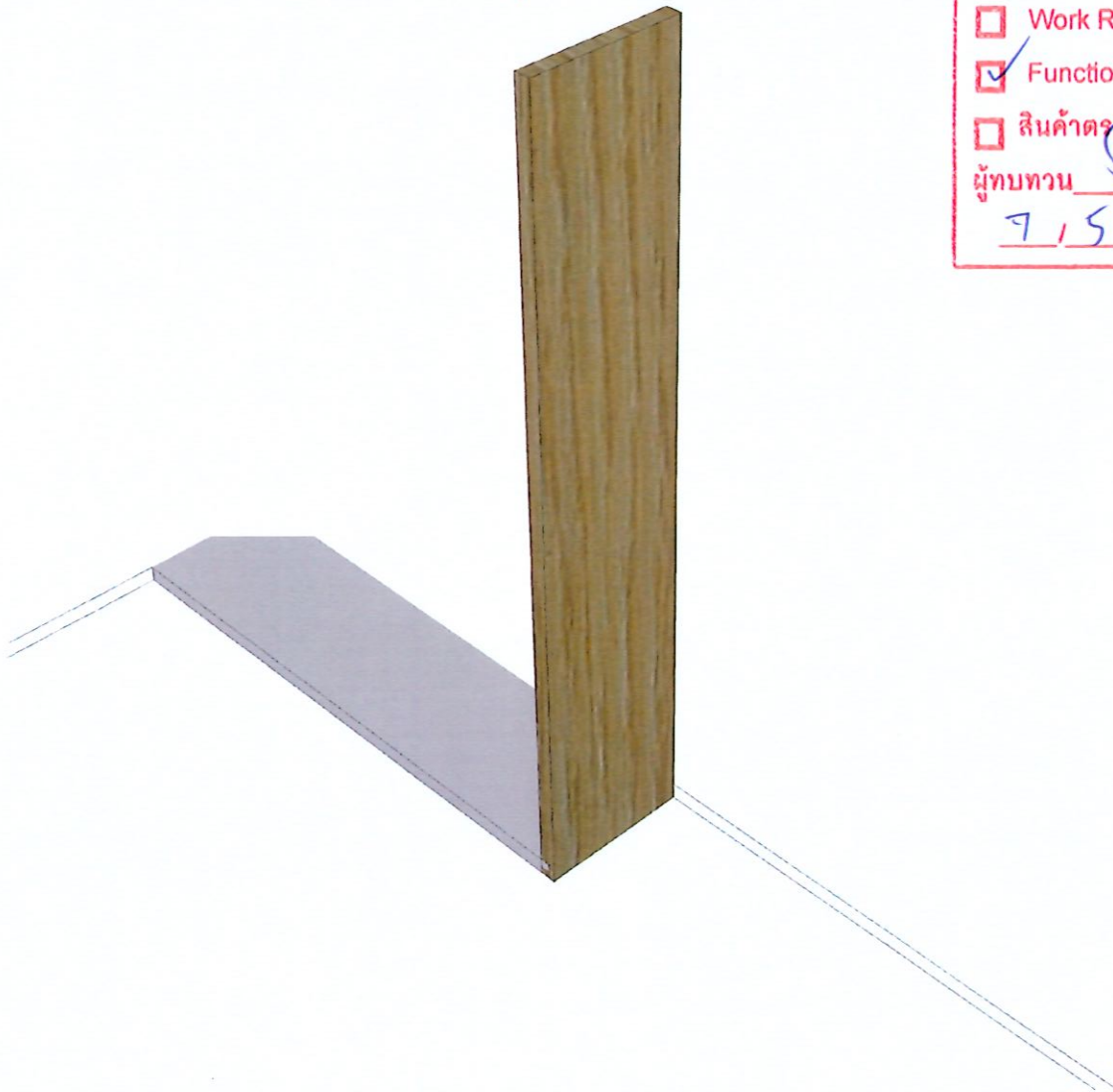

Model	ESCENT_BNA_DFCL_1450		
Creator	SUTTHI.P	.BCP Name	INDEX_C3D_KITCHENPAE
Reviewer		Order	0003065
Approves	P.SAWA	Date	30/01/2026

ESCENT_BNA_DFCL_1450-1450X9X120

Colour

05.01=ML WHITE VM1012 18/18
05.72=ML.MD645 LONG BEACH (SN)

Edge

01.24=0.6 WHITE
01.392=1 LONG BEACH-MD645 (MW40-A1059TH00)

K1R 160175432

K1L 160177227

R&D REVIEW	
<input checked="" type="checkbox"/>	DWG.Customer
<input type="checkbox"/>	Work Report
<input type="checkbox"/>	Function
<input type="checkbox"/>	สินค้าตรงตัวอย่าง
ผู้ทบทวน <u>P.SAWA</u>	
<u>31 / 1 / 69</u>	

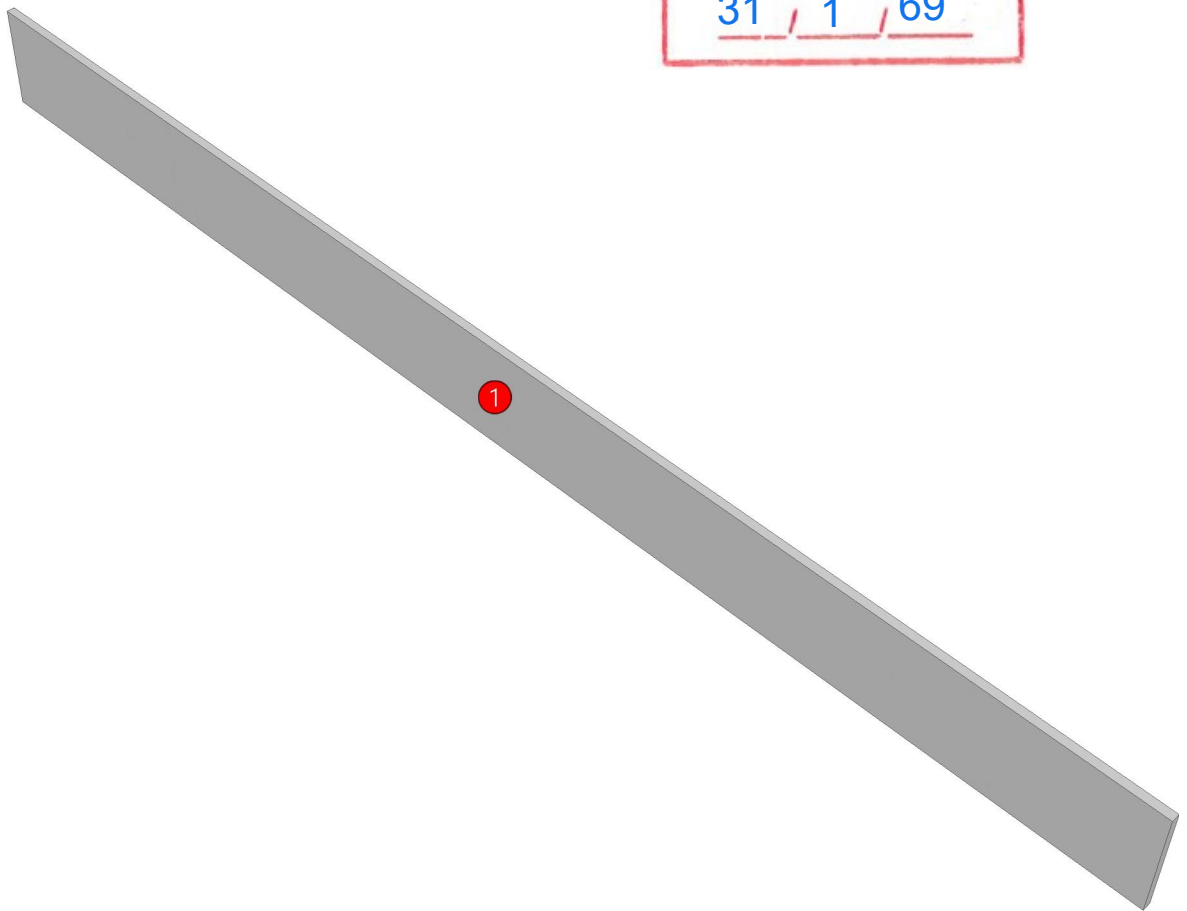

Model	-ESCENT_BNA_DFCL_1450		
Creator	SUTTHI.P	.BCP Name	INDEX_C3D_KITCHENPAE
Reviewer		Order	0003065
Approves	P. SAWA	Date	30/01/2026

1

Model	ESCENT_BNA_DFCL_300		
Creator	SUTTHI.P	.BCP Name	INDEX_C3D_KITCHENPAE
Reviewer		Order	0003067
Approves	P.SAWA	Date	30/01/2026

ESCENT_BNA_DFCL_300-300X9X120

Colour

05.01=ML WHITE VM1012 18/18
05.72=ML.MD645 LONG BEACH (SN)

Edge

01.24=0.6 WHITE
01.392=1 LONG BEACH-MD645 (MW40-A1059TH00)

K1R 160175432

K1L 160177227

K15R_160178565

R&D REVIEW	
<input checked="" type="checkbox"/>	DWG.Customer
<input type="checkbox"/>	Work Report
<input type="checkbox"/>	Function
<input type="checkbox"/>	สินค้าตรงตัวอย่าง
ผู้ทบทวน <u>P.SAWA</u>	
<u>31 / 1 / 69</u>	

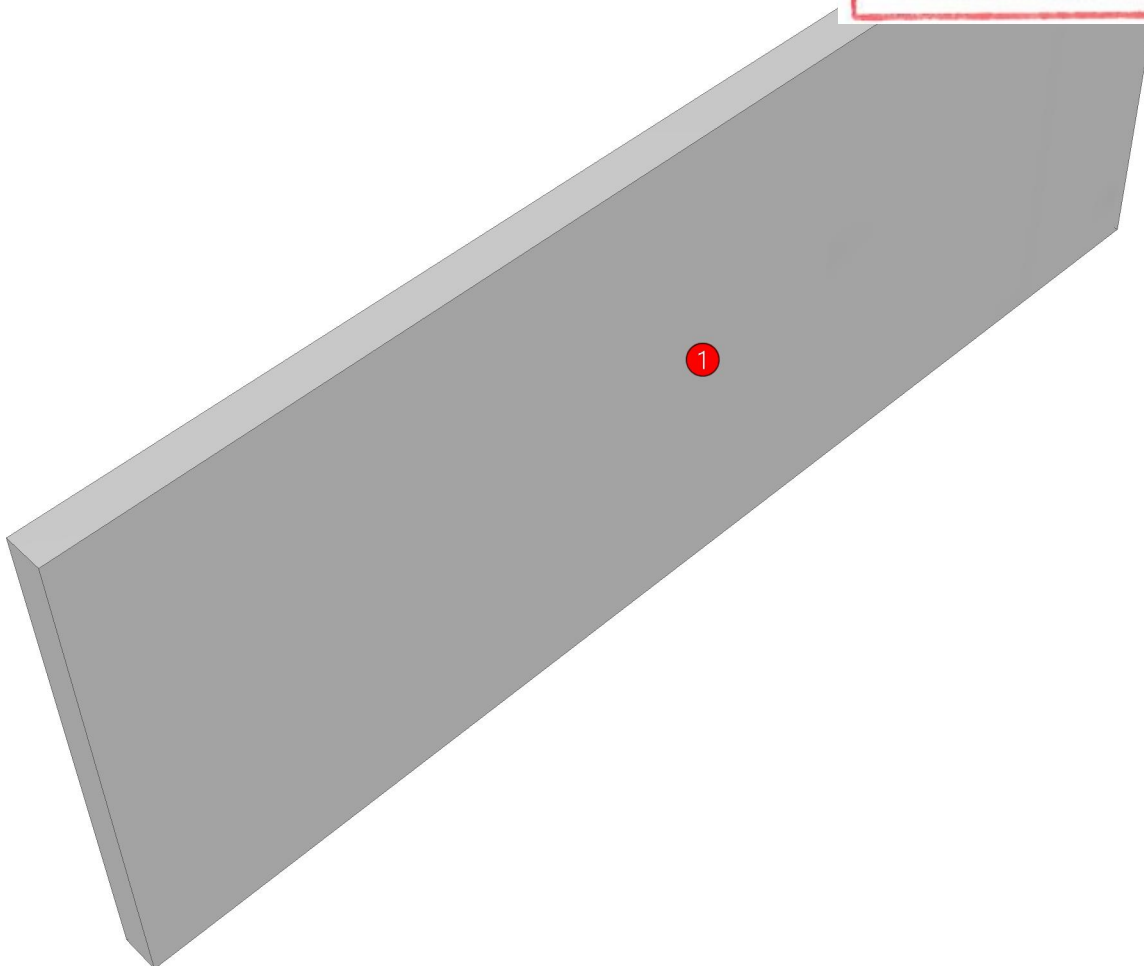

Model	-ESCENT_BNA_DFCL_300		
Creator	SUTTHI.P	.BCP Name	INDEX_C3D_KITCHENPAE
Reviewer		Order	0003067
Approves	<i>P. SAWA</i>	Date	30/01/2026

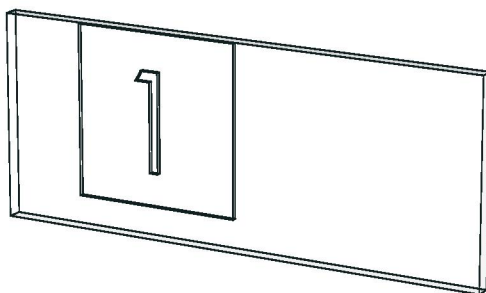

Model	ESCENT_BNA_DFLMV_		
Creator	SUTTHI.P	.BCP Name	INDEX_C3D_KITCHENPAE
Reviewer		Order	O003077
Approves		Date	01/04/2026

ESCENT_BNA_DFLMV_-150X300X800

Colour

05.01=ML WHITE VM1012 18/18

05.72=ML.MD645 LONG BEACH (SN)

Edge

01.24=0.6 WHITE

01.392=1 LONG BEACH-MD645 (MW40-A1059TH00)

K1R_160175432

K2R_160175441

K1L_160177227

K2L_160177236

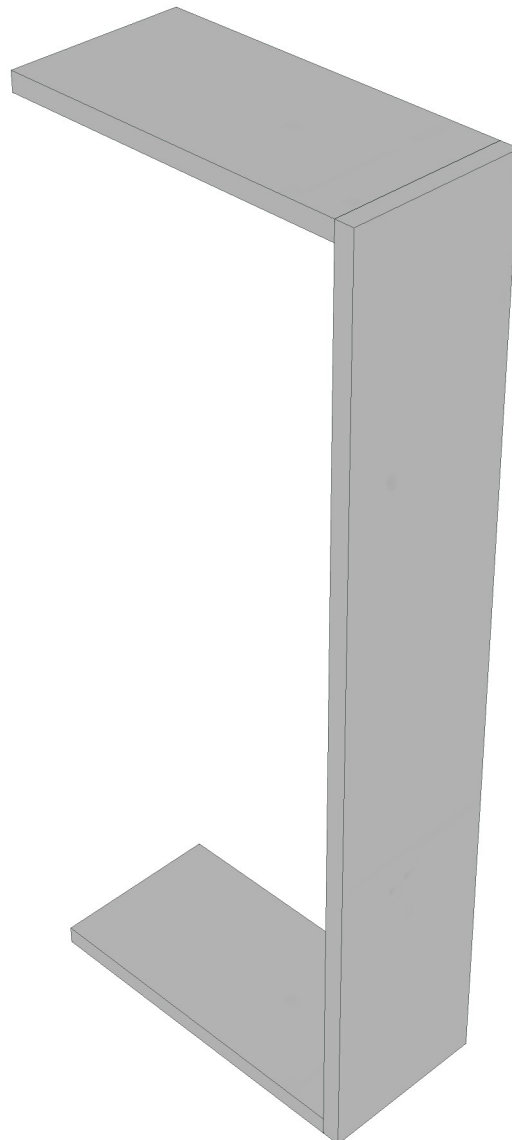

Model	-ESCENT_BNA_DFLMV_		
Creator		.BCP Name	INDEX_C3D_KITCHENPAE
Reviewer		Order	I003077
Approves		Date	

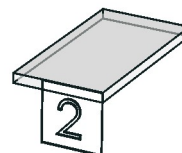

Model	ESCENT_BNA_D_FLR_650S		
Creator	SUTTHI.P	.BCP Name	INDEX_C3D_KITCHENPAE
Reviewer		Order	O003048
Approves	P.SAWA	Date	24/01/2026

ESCENT_BNA_D_FLR_650S-650X570X722

Colour

05.01=ML WHITE VM1012 18/18
05.72=ML.MD645 LONG BEACH (SN)

Edge

01.24=0.6 WHITE
01.392=1 LONG BEACH-MD645 (MW40-A1059TH00)

K1R 160175432

K1L 160177227

K2R 160175441

K2L 160177236

R&D REVIEW	
<input checked="" type="checkbox"/>	DWG.Customer
<input type="checkbox"/>	Work Report
<input type="checkbox"/>	Function
<input type="checkbox"/>	สินค้าตรงตัวอย่าง
ผู้ทบทวน <u>P.SAWA</u>	
<u>31 / 1 / 69</u>	



Model	-ESCENT_BNA_D_FLR_650S		
Creator	SUTTHI.P	.BCP Name	INDEX_C3D_KITCHENPAE
Reviewer		Order	0003048
Approves	<i>P. SAWA</i>	Date	24/01/2026

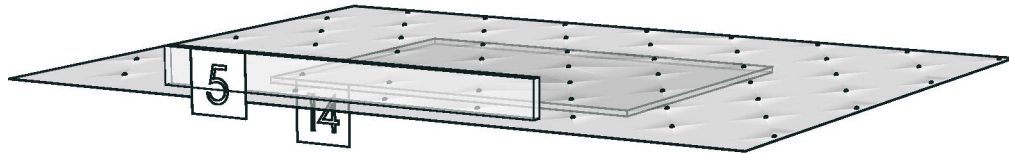

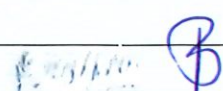
Model	ESCENT_BNA_DL60HL		
Creator	SUTTHI,P	.BCP Name	INDEX_C3D_KITCHENPAE
Reviewer		Order	O003050
Approves		Date	24/01/2026

ESCENT_BNA_DL60HL-600X300X600

Colour

05.01=ML WHITE VM1012 18/18
05.72=ML.MD645 LONG BEACH (SN)

Edge

01.24=0.6 WHITE
01.392=1 LONG BEACH-MD645 (MW40-A1059TH00)

K1R 160175432

K2R 160175441

K3R 160177246

K15R_160178565



R&D REVIEW	
<input checked="" type="checkbox"/>	DWG.Customer
<input type="checkbox"/>	Work Report
<input checked="" type="checkbox"/>	Function
<input type="checkbox"/>	สินค้าตรงตัวอย่าง
ผู้ทบทวน 	
7 / 5 / 69	

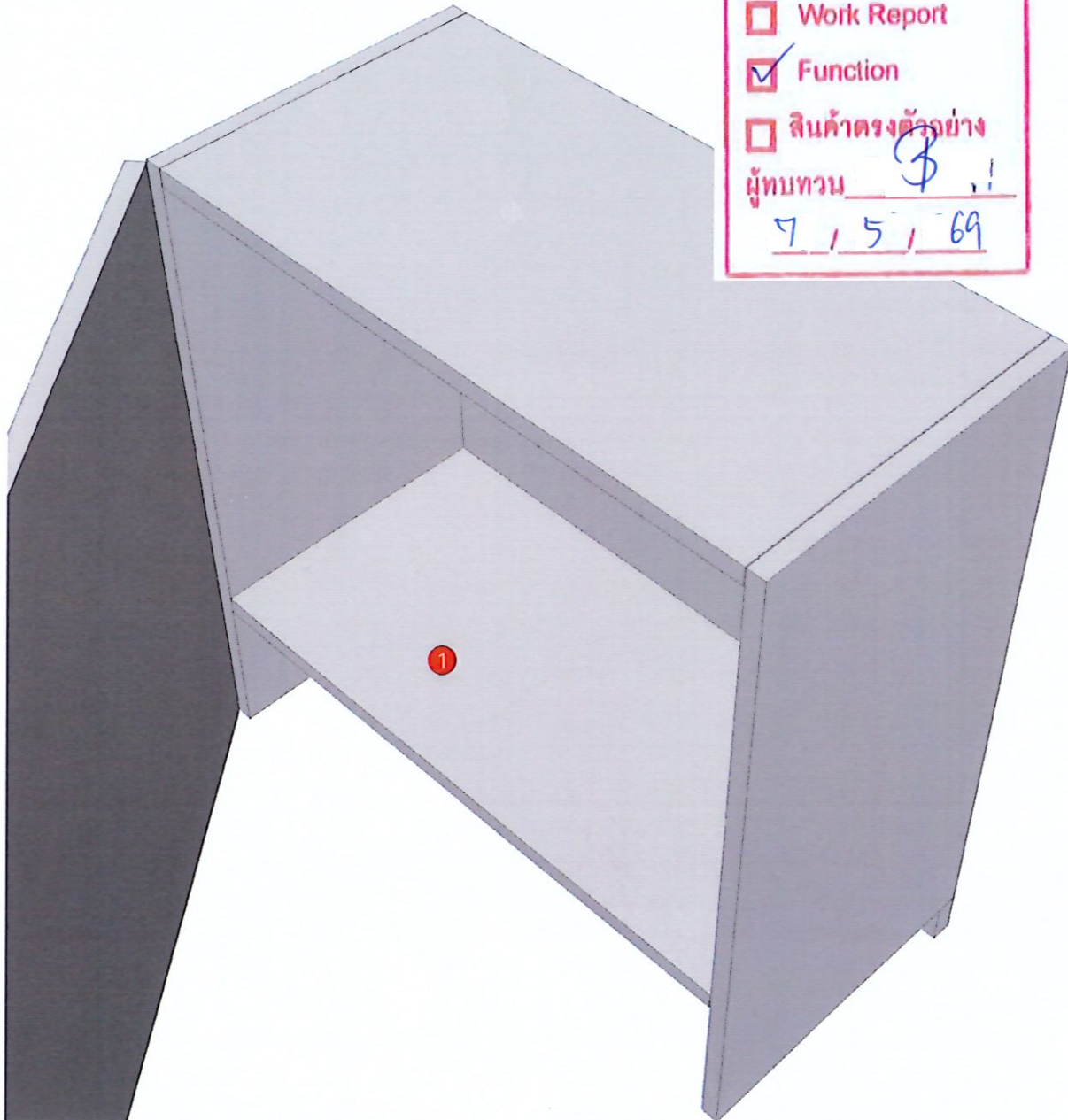

Model	ESCENT_BNA_DLMV75R		
Creator	SUTTHI.P	.BCP Name	INDEX_C3D_KITCHENPAE
Reviewer		Order	0003053
Approves	<i>P.SAWA</i>	Date	28/01/2026

ESCENT_BNA_DLMV75R-750X300X800

Colour

05.01=ML WHITE VM1012 18/18
05.72=ML.MD645 LONG BEACH (SN)

Edge

01.24=0.6 WHITE
01.392=1 LONG BEACH-MD645 (MW40-A1059TH00)

K1R 160175432

R&D REVIEW	
<input checked="" type="checkbox"/>	DWG.Customer
<input type="checkbox"/>	Work Report
<input type="checkbox"/>	Function
<input type="checkbox"/>	สินค้าตรงตัวอย่าง
ผู้ทบทวน <u>P.SAWA</u>	
<u>31 / 1 / 69</u>	

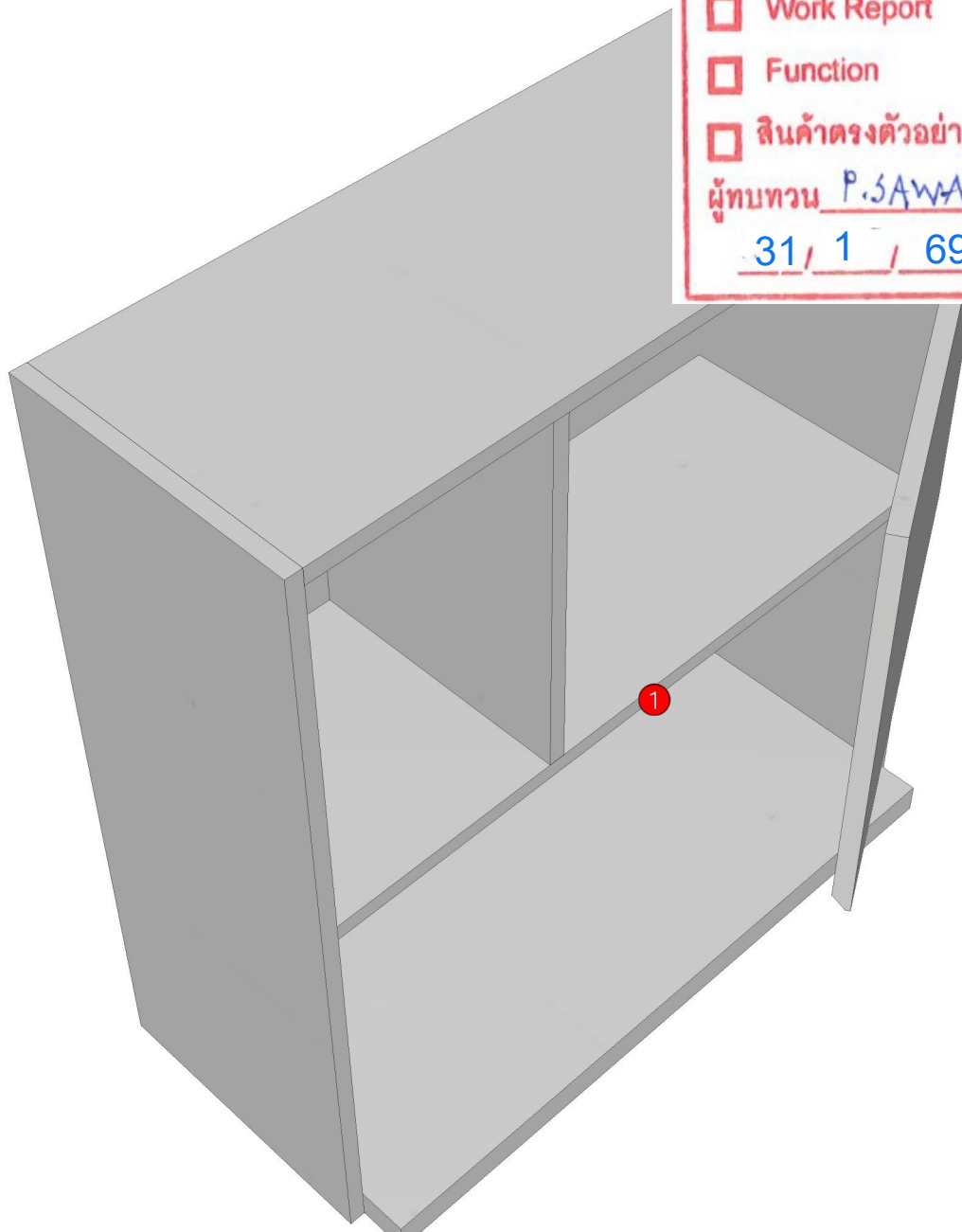

Model	-ESCENT_BNA_DLMV75R		
Creator	SUTTHI.P	.BCP Name	INDEX_C3D_KITCHENPAE
Reviewer		Order	0003053
Approves	<i>P. SAWA</i>	Date	28/01/2026

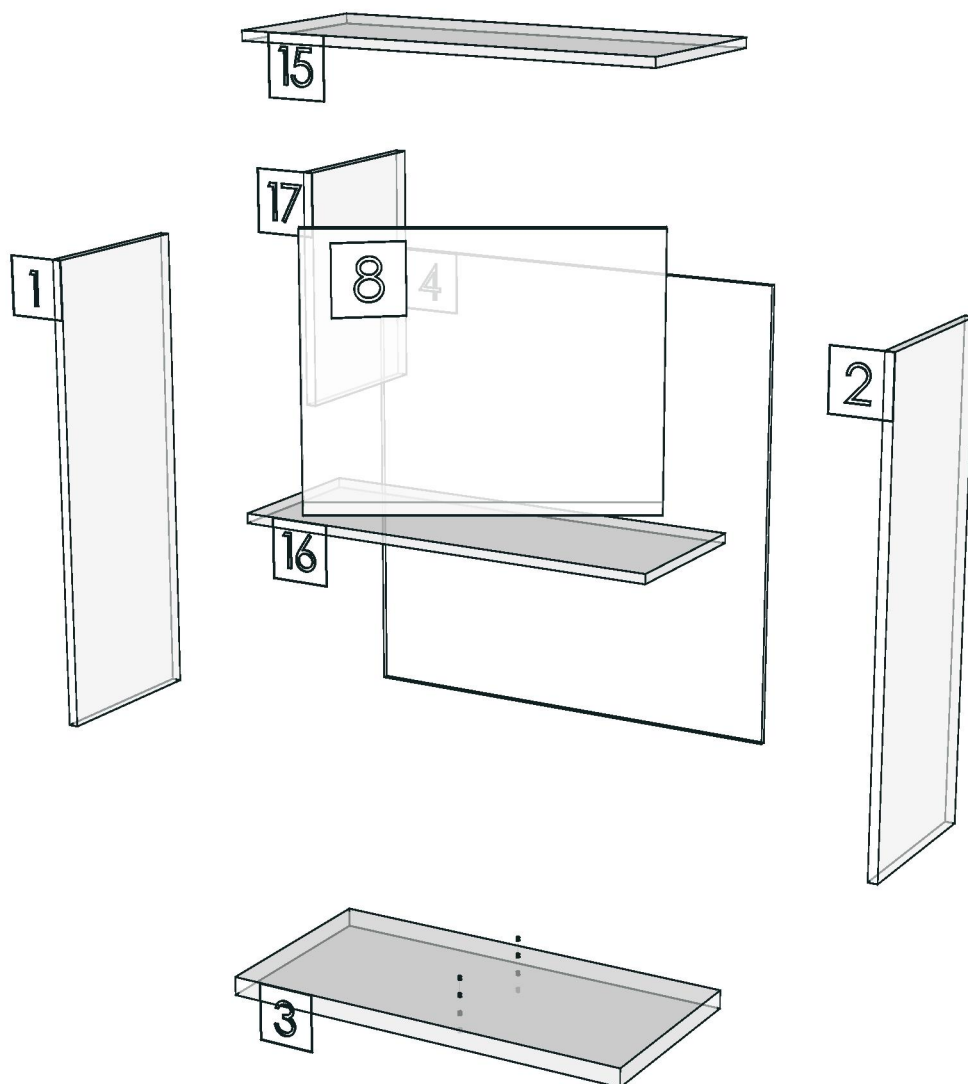

Model	ESCENT_BNA_DUT_1450		
Creator	SUTTHI.P	.BCP Name	INDEX_C3D_KITCHENPAE
Reviewer		Order	O003071
Approves	P.SAWA	Date	30/01/2026

ESCENT_BNA_DUT_1450-1450X9X60

Colour

05.01=ML WHITE VM1012 18/18
05.72=ML.MD645 LONG BEACH (SN)

Edge

01.24=0.6 WHITE
01.392=1 LONG BEACH-MD645 (MW40-A1059TH00)

K1R 160175432

K1L 160177227

R&D REVIEW	
<input checked="" type="checkbox"/>	DWG.Customer
<input type="checkbox"/>	Work Report
<input type="checkbox"/>	Function
<input type="checkbox"/>	สินค้าตรงตัวอย่าง
ผู้ทบทวน <u>P.SAWA</u>	
<u>31</u> / <u>1</u> / <u>69</u>	

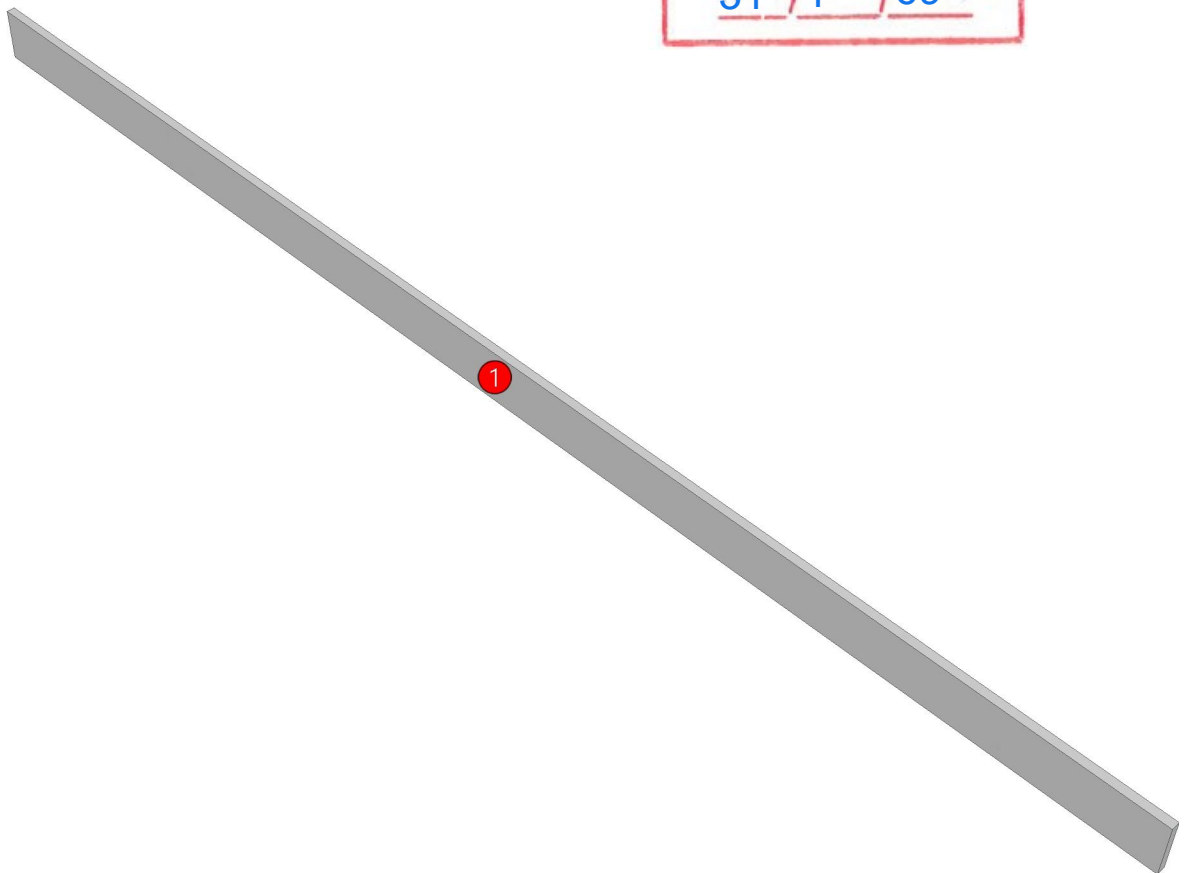

Model	-ESCENT_BNA_DUT_1450		
Creator	SUTTHI.P	.BCP Name	INDEX_C3D_KITCHENPAE
Reviewer		Order	0003071
Approves	P. SAWA	Date	30/01/2026



Model	ESCENT_BNA_DUT_500		
Creator	SUTTHI,P	.BCP Name	INDEX_C3D_KITCHENPAE
Reviewer		Order	O003073
Approves		Date	30/01/2026

ESCENT_BNA_DUT_500-500X9X60

Colour

05.01=ML WHITE VM1012 18/18
05.72=ML.MD645 LONG BEACH (SN)

Edge

01.24=0.6 WHITE
01.392=1 LONG BEACH-MD645 (MW40-A1059TH00)

K1R 160175432

K2R 160175441

K3L 160175451

K1L 160177227

K2L 160177236

K3R 160177246

K15R_160178565



R&D REVIEW	
<input checked="" type="checkbox"/>	DWG.Customer
<input type="checkbox"/>	Work Report
<input checked="" type="checkbox"/>	Function
<input type="checkbox"/>	สินค้าตรงตัวอย่าง
ผู้ทบทวน 	
๗, ๕, ๖๙	

