

Model	RF_KS_DB45L		
Creator	CHALEAMPHON	.BCP Name	INDEX_C3D_KITCHEN2
Reviewer		Order	H002194
Approves		Date	18/12/2025

RF_KS_DB45L-450X570X738

Colour

05.107=ML.TONIC#MD716 (EVELYN)

05.01=ML WHITE VM1012 18/18

Edge

01.344=1 MD716

01.47=1 WHITE



K3R-160174741

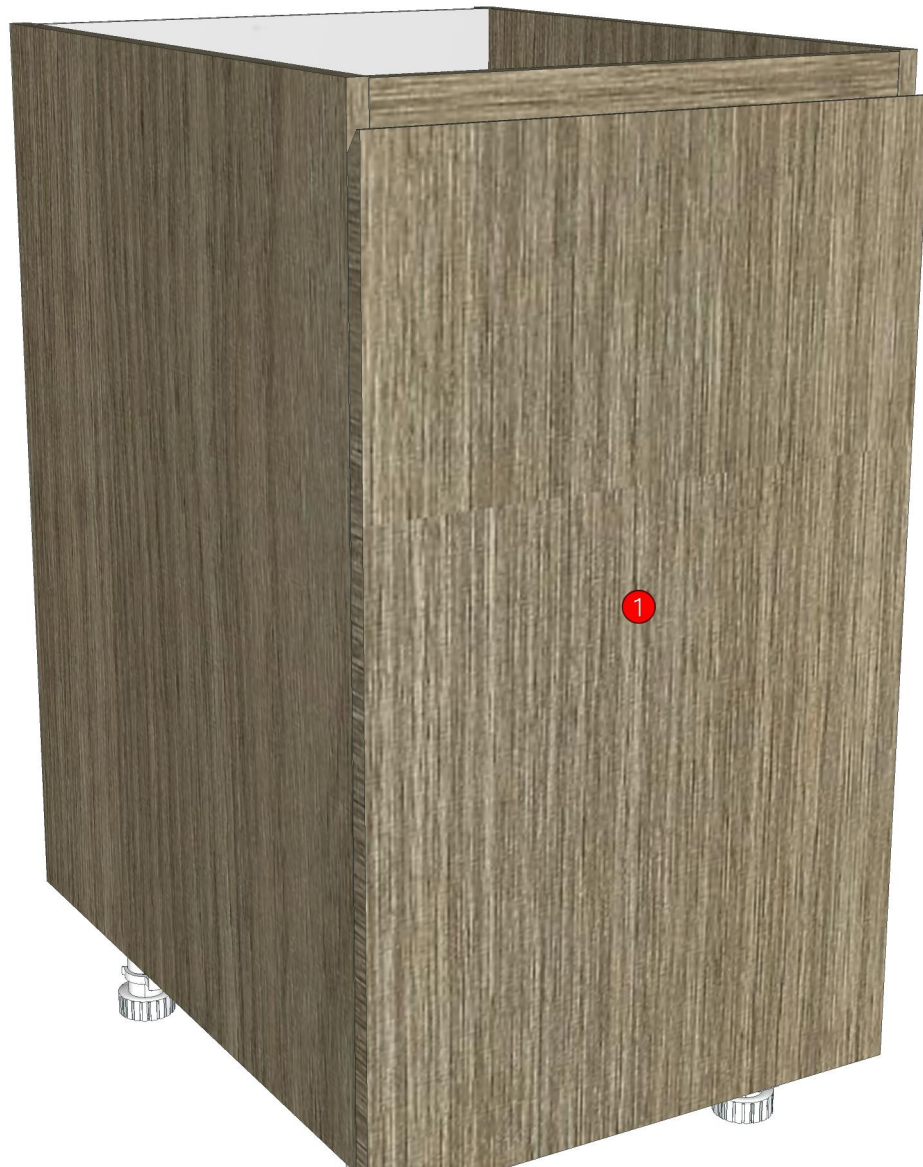

Model	-		
Creator	CHALEAMPHON	.BCP Name	INDEX_C3D_KITCHEN2
Reviewer		Order	H002194
Approves		Date	18/12/2025

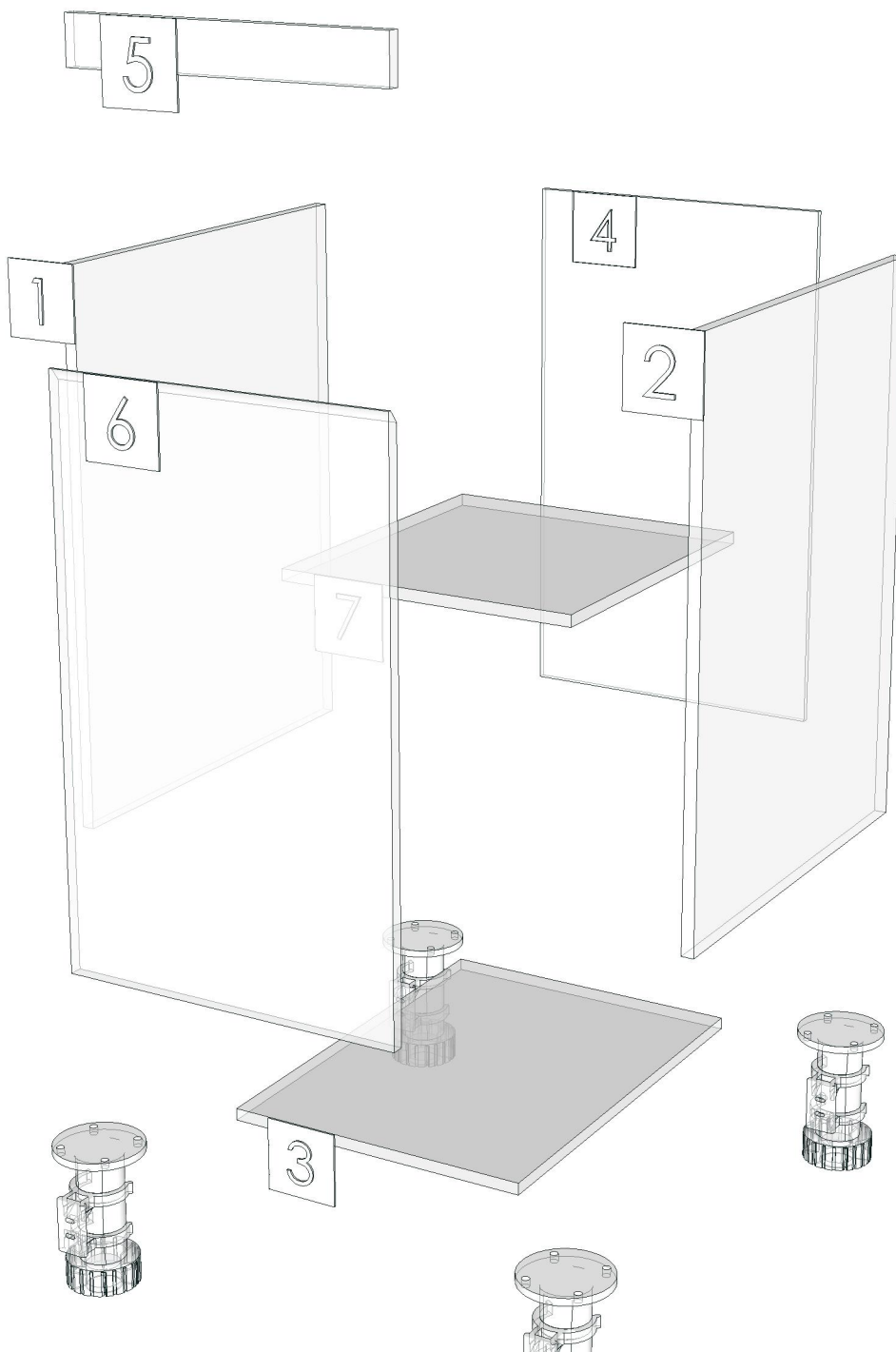

Model	RF_KS_DBH602		
Creator	CHALEAMPHON	.BCP Name	INDEX_C3D_KITCHEN2
Reviewer		Order	H001939
Approves		Date	13/08/2025

RF_KS_DBH602-600X570X738

Colour

05.107=ML.TONIC#MD716 (EVELYN)

05.01=ML WHITE VM1012 18/18

Edge

01.344=1 MD716

01.47=1 WHITE



K1L-160169808

K1R-160174721

K2L-160174732

K3R-160174741



Model	-RF_K		
Creator	CHALEAMPHON	.BCP Name	INDEX_C3D_KITCHEN2
Reviewer		Order	H001939
Approves		Date	13/08/2025

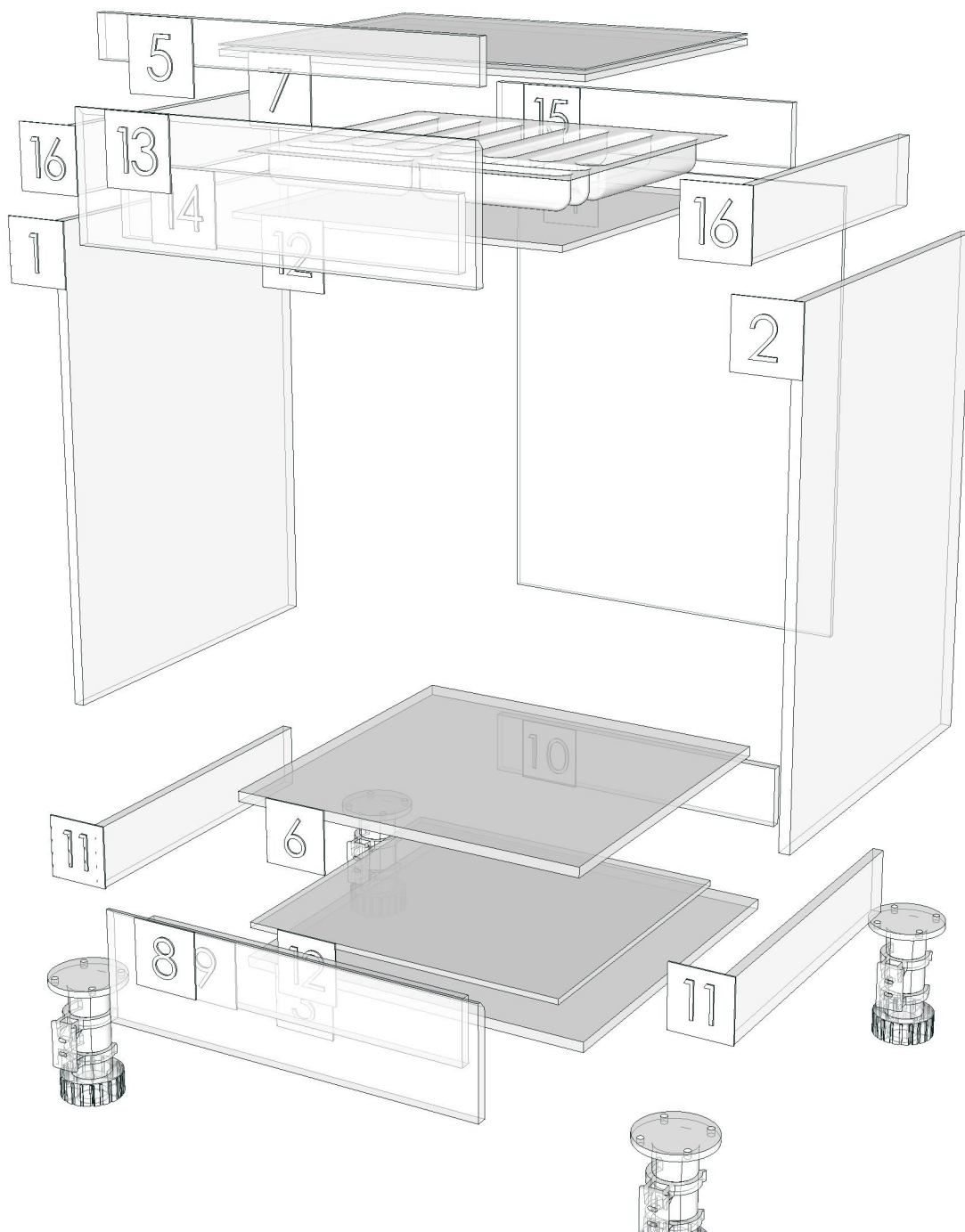

Model	RF_KS_DBS60		
Creator	CHALEAMPHON	.BCP Name	INDEX_C3D_KITCHEN2
Reviewer		Order	H001941
Approves		Date	17/09/2025

RF_KS_DBS60-600X570X738

Colour

05.107=ML.TONIC#MD716 (EVELYN)

05.01=ML WHITE VM1012 18/18

Edge

01.344=1 MD716

01.47=1 WHITE



K2L-160174732

K3R-160174741



Model	-		
Creator	CHALEAMPHON	.BCP Name	INDEX_C3D_KITCHEN2
Reviewer		Order	H001941
Approves		Date	17/09/2025

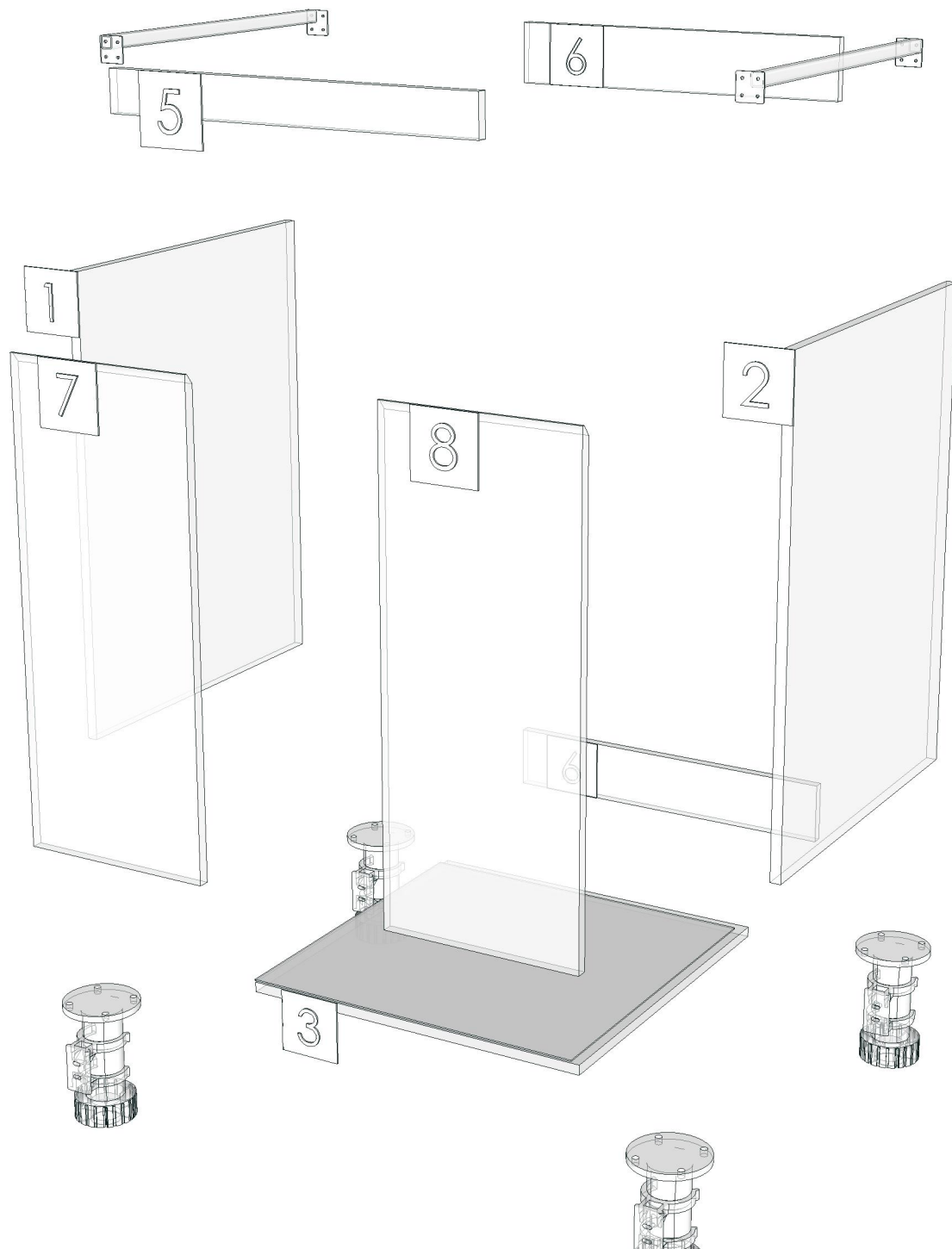

Model	RF_KS_DDM_1750		
Creator	CHALEAMPON	.BCP Name	INDEX_C3D_KITCHEN2
Reviewer		Order	H002199
Approves		Date	19/12/2025

RF_KS_DDM_1750-1750X6X550

Colour

03.13=PVC WHITE#630 T0.15MM.

Edge

R&D REVIEW	
<input checked="" type="checkbox"/>	DWG.Customer
<input checked="" type="checkbox"/>	Work Report
<input type="checkbox"/>	Function
<input type="checkbox"/>	สินค้าตรงตัวอย่าง
ผู้ทบทวน <u>P.SAWAI</u>	
<u>22/12/25</u>	

K3R-160174741

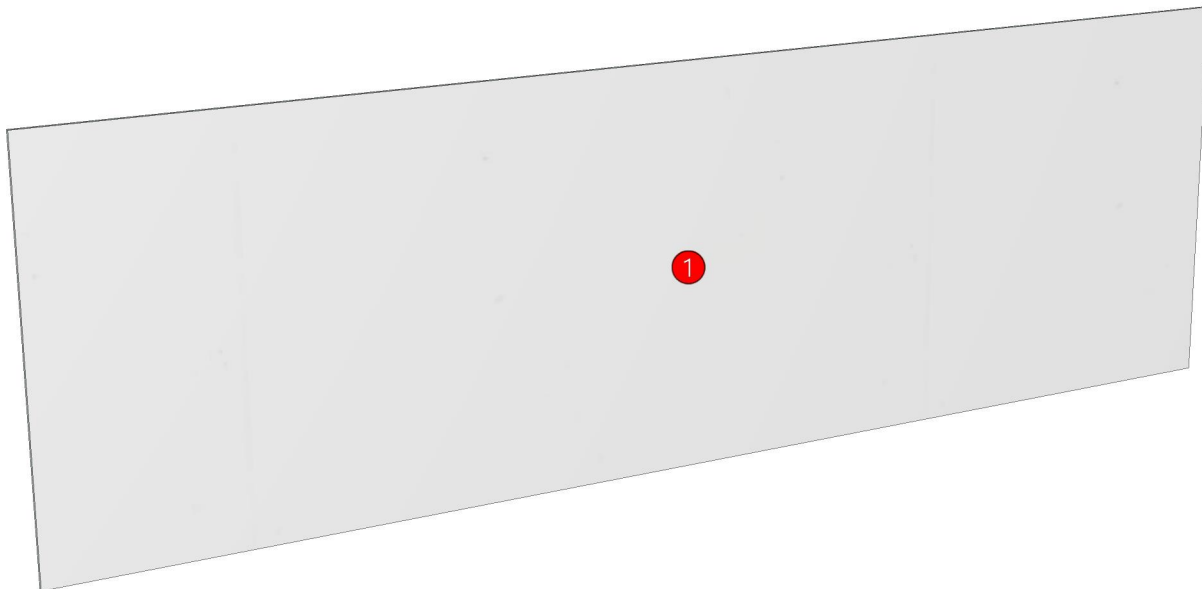

Model	RF_KS_DDM_1750		
Creator	CHALEAMPON	.BCP Name	INDEX_C3D_KITCHEN2
Reviewer		Order	H002199
Approves		Date	19/12/2025

No.	Article No.	Description	Mat	Dimension	Cutting Size	Typepology	Skin
0	RF_KS_DDM_1750			1750x550x6			
	RF_KS_DDM_1750-01	WALL MOUNT	MDF-ST	6x550x1750	6X550X1750;NO EDGE	183000_STR=03.13_EDG=-	2

Model	RF_KS_DFB		
Creator	CHALEAMPHON	.BCP Name	INDEX_C3D_KITCHEN2
Reviewer		Order	H001961
Approves		Date	26/08/2025

RF_KS_DFB-150X570X738

Colour

05.107=ML.TONIC#MD716 (EVELYN)

05.01=ML WHITE VM1012 18/18

Edge

01.344=1 MD716

01.47=1 WHITE



K2L-160147432

K3R160174741



Model	-		
Creator	CHALEAMPON	.BCP Name	INDEX_C3D_KITCHEN2
Reviewer		Order	H001961
Approves		Date	26/08/2025

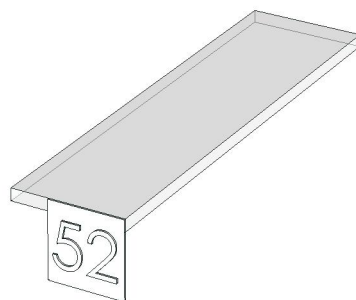
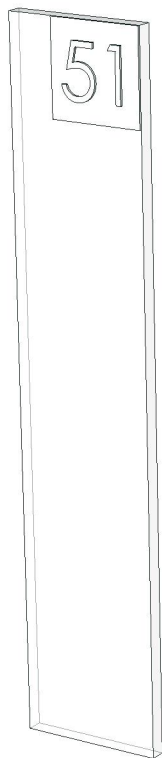

Model	RF_KS_DFCL_2430		
Creator	CHALEAMPHON	.BCP Name	INDEX_C3D_KITCHEN2
Reviewer		Order	H001965
Approves		Date	02/09/2025

RF_KS_DFCL_2430-2430X9X100

Colour

05.107=ML.TONIC#MD716 (EVELYN)

05.01=ML WHITE VM1012 18/18

Edge

01.344=1 MD716

01.47=1 WHITE

R&D REVIEW	
<input checked="" type="checkbox"/>	DWG.Customer
<input checked="" type="checkbox"/>	Work Report
<input type="checkbox"/>	Function
<input type="checkbox"/>	สินค้าตรงตัวอย่าง
ผู้ทบทวน <u>P.SAWAI</u>	
<u>02/09/25</u>	

K1L-160169808

K1R-160174721

K3R-160174741

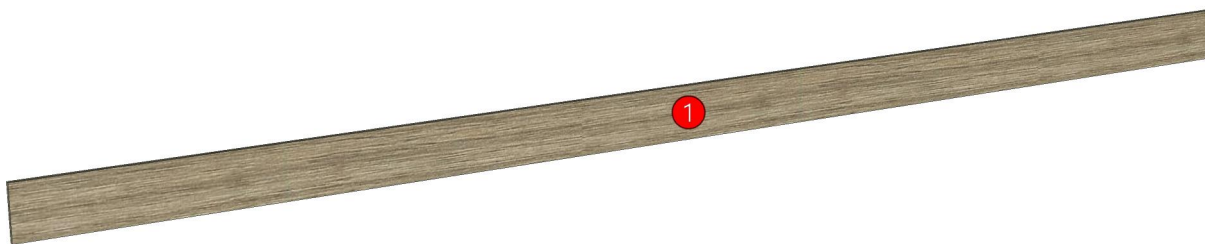

Model	RF_KS_DFCL_2430		
Creator	CHALEAMPHON	.BCP Name	INDEX_C3D_KITCHEN2
Reviewer		Order	H001965
Approves		Date	02/09/2025

No.	Article No.	Description	Mat	Dimension	Cutting Size	Typepology	Skin
0	RF_KS_DFCL_2430			2430x100x9			
	RF_KS_DFCL_2430-01	FILLER TOP	PB-ST	9x100x2430	9X99X2429;L1:W1	183000_STR=05.107_EDG=MD716-1	2

Model	RF_KS_DFL		
Creator	CHALEAMPHON	.BCP Name	INDEX_C3D_KITCHEN2
Reviewer		Order	H001962
Approves		Date	26/08/2025

RF_KS_DFL-150X300X900

Colour

05.107=ML.TONIC#MD716 (EVELYN)

05.01=ML WHITE VM1012 18/18

Edge

01.344=1 MD716

01.47=1 WHITE



K4L-160169819
K2L-160174732
K3R-160174741
K5R-160174753



Model	-		
Creator	CHALEAMPHON	.BCP Name	INDEX_C3D_KITCHEN2
Reviewer		Order	H001962
Approves		Date	26/08/2025

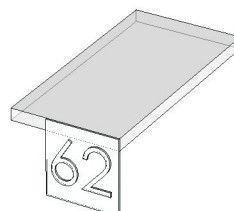
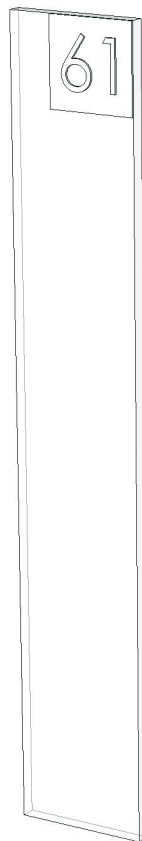
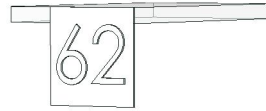

Model	RF_KS_DFW		
Creator	CHALEAMPHON	.BCP Name	INDEX_C3D_KITCHEN2
Reviewer		Order	H002225
Approves		Date	12/01/2026

RF_KS_DFW-150X300X600

Colour

05.107=ML.TONIC#MD716 (EVELYN)

05.01=ML WHITE VM1012 18/18

Edge

01.344=1 MD716

01.47=1 WHITE

R&D REVIEW	
<input checked="" type="checkbox"/>	DWG.Customer
<input checked="" type="checkbox"/>	Work Report
<input type="checkbox"/>	Function
<input type="checkbox"/>	สินค้าตรงตัวอย่าง
ผู้ทบทวน <u>P.SAWAI</u>	
<u>22/01/2026</u>	

K3R-160174741



Model	-		
Creator	CHALEAMPON	.BCP Name	INDEX_C3D_KITCHEN2
Reviewer		Order	H002225
Approves		Date	12/01/2026

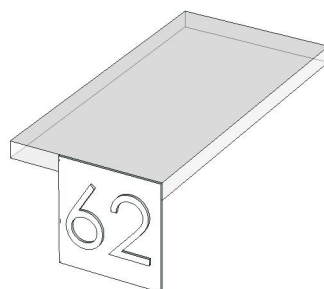
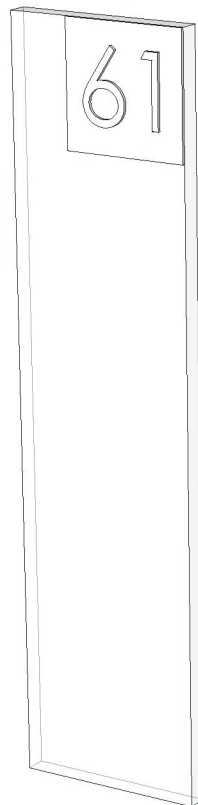
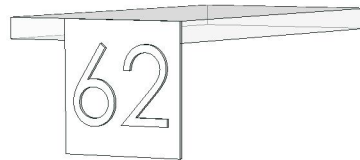

Model	RF_KS_DL45L		
Creator	CHALEAMPHON	.BCP Name	INDEX_C3D_KITCHEN2
Reviewer		Order	H002216
Approves		Date	09/01/2026

RF_KS_DL45L-450X300X900

Colour

05.107=ML.TONIC#MD716 (EVELYN)

05.01=ML WHITE VM1012 18/18

Edge

01.344=1 MD716

01.47=1 WHITE



K3R-160174741



Model	-		
Creator	CHALEAMPHON	.BCP Name	INDEX_C3D_KITCHEN2
Reviewer		Order	H002216
Approves		Date	09/01/2026

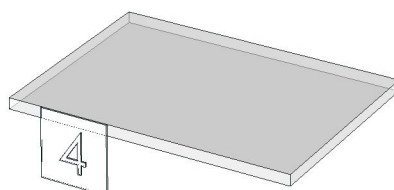
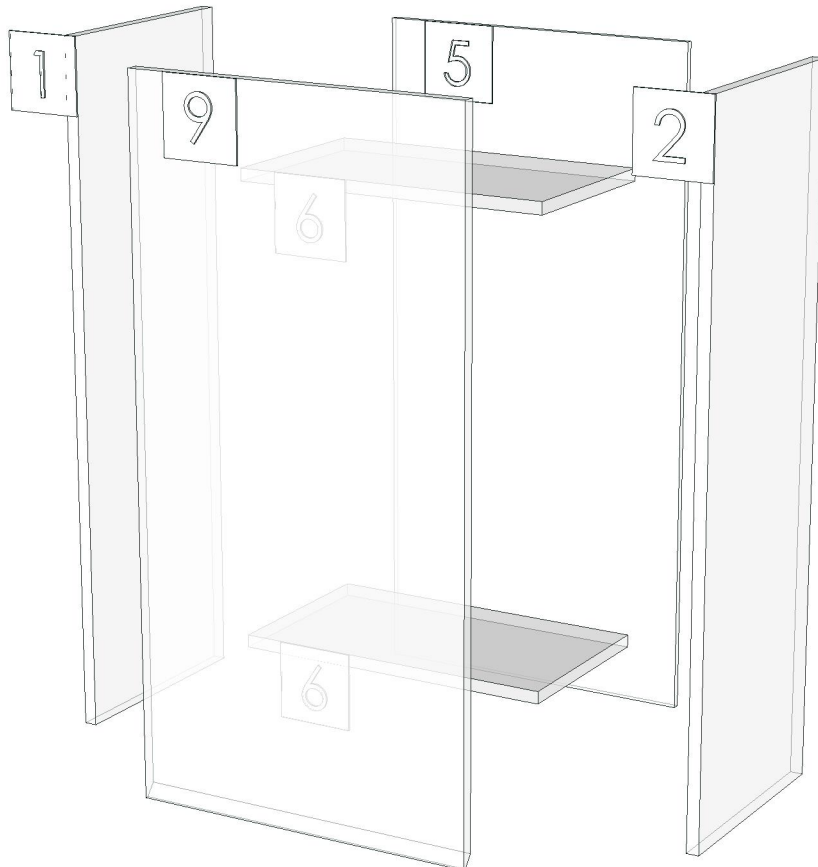

Model	RF_KS_DL60(H)		
Creator	CHALEAMPHON	.BCP Name	INDEX_C3D_KITCHEN2
Reviewer		Order	H001957
Approves		Date	21/08/2025

RF_KS_DL60(H)-600X300X860

Colour

05.107=ML.TONIC#MD716 (EVELYN)

05.01=ML WHITE VM1012 18/18

Edge

01.344=1 MD716

01.47=1 WHITE



- K2L-160174732
- K3R-160174741
- K4L-160169819
- K5R-160174753



Model	-		
Creator	CHALEAMPHON	.BCP Name	INDEX_C3D_KITCHEN2
Reviewer		Order	H001957
Approves		Date	21/08/2025

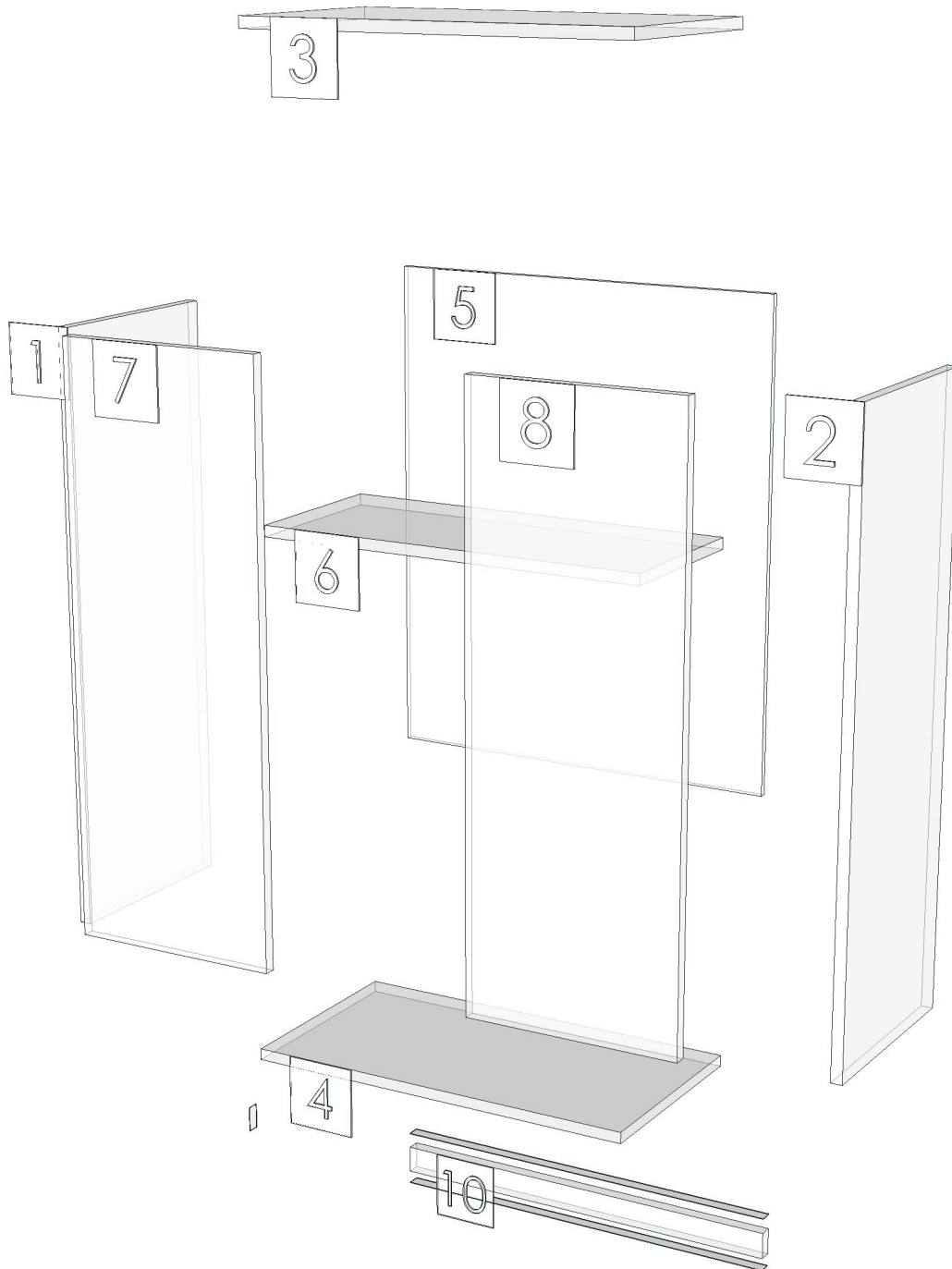

Model	RF_KS_DL60		
Creator	CHALEAMPHON	.BCP Name	INDEX_C3D_KITCHEN2
Reviewer		Order	H001944
Approves		Date	14/08/2025

RF_KS_DL60-600X300X900

Colour

05.107=ML.TONIC#MD716 (EVELYN)

05.01=ML WHITE VM1012 18/18

Edge

01.344=1 MD716

01.47=1 WHITE

R&D REVIEW	
<input checked="" type="checkbox"/>	DWG.Customer
<input checked="" type="checkbox"/>	Work Report
<input type="checkbox"/>	Function
<input type="checkbox"/>	สินค้าตรงตัวอย่าง
ผู้ทบทวน <u>P.SAWAI</u>	
<u>22/8/25</u>	

K2L-160174732

K3R-160174741



Model	-RF_K		
Creator	CHALEAMPHON	.BCP Name	INDEX_C3D_KITCHEN2
Reviewer		Order	H001944
Approves		Date	14/08/2025

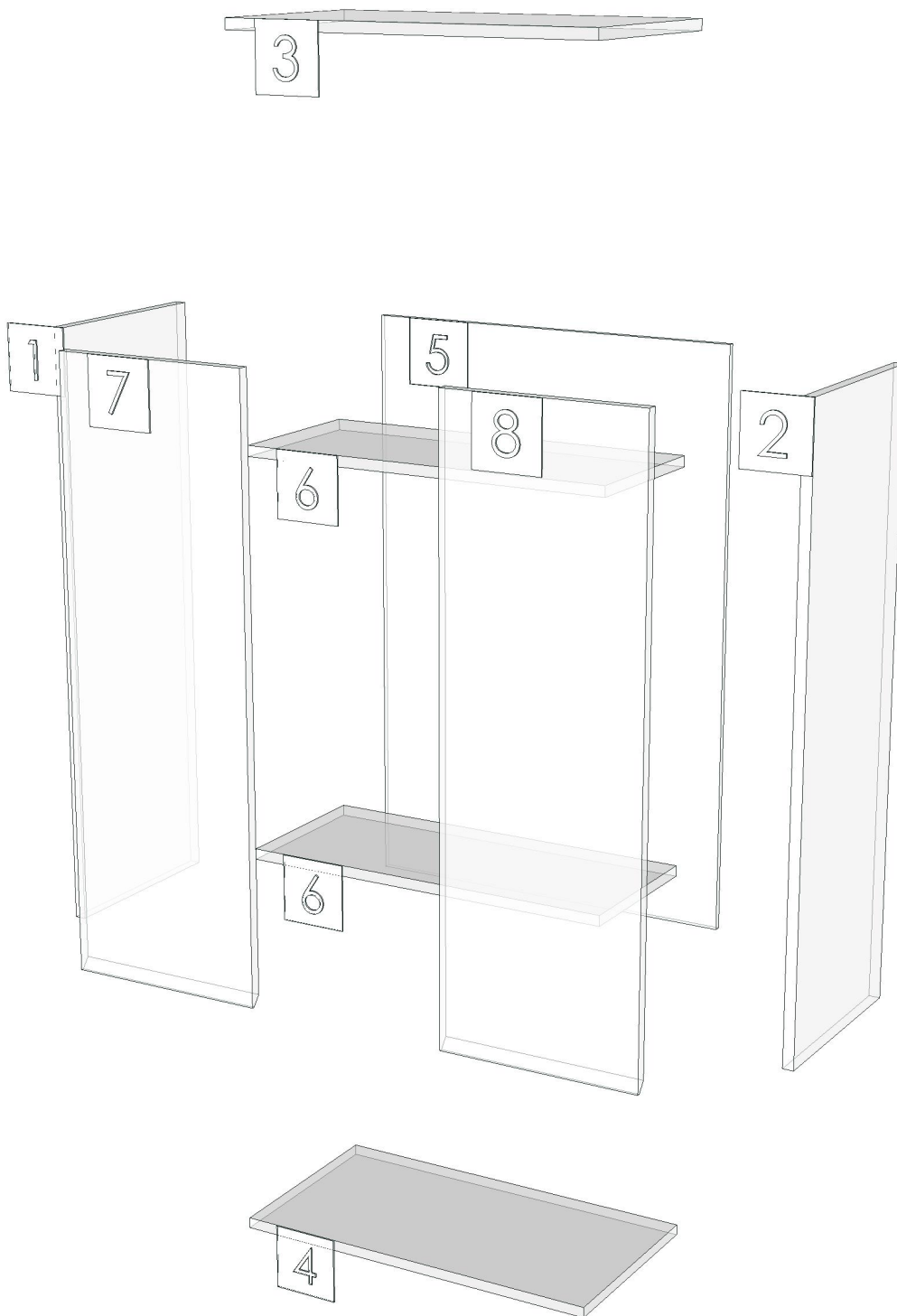

Model	RF_KS_DPLT_1750		
Creator	CHALEAMPHON	.BCP Name	INDEX_C3D_KITCHEN2
Reviewer		Order	H002227
Approves		Date	12/01/2026

RF_KS_DPLT_1750-1750X9X100

Colour

05.107=ML.TONIC#MD716 (EVELYN)

05.01=ML WHITE VM1012 18/18

Edge

01.344=1 MD716

01.47=1 WHITE



K3R-160174741

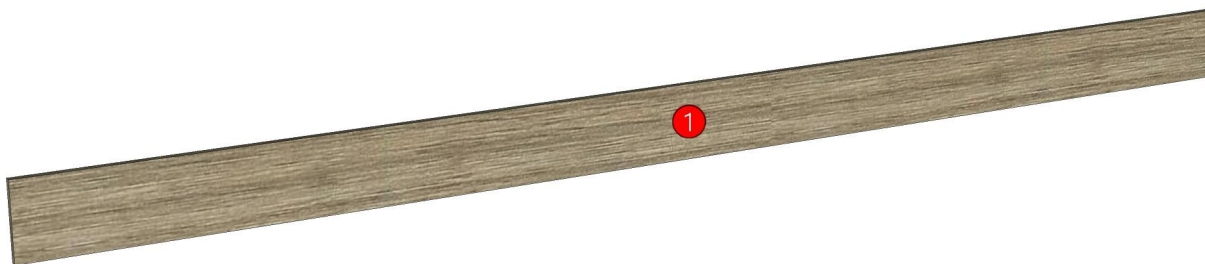

Model	RF_KS_DPLT_1750		
Creator	CHALEAMPHON	.BCP Name	INDEX_C3D_KITCHEN2
Reviewer		Order	H002227
Approves		Date	12/01/2026

No.	Article No.	Description	Mat	Dimension	Cutting Size	Typepology	Skin
0	RF_KS_DPLT_1750			1750x100x9			
	RF_KS_DPLT_1750-02	LED BOTTOM	PB-ST	9x100x1750	9X98X1749;L2:W1	183000_STR=05.107_EDG=MD716-1	2

Model	RF_KS_DPLT_600		
Creator	CHALEAMPHON	.BCP Name	INDEX_C3D_KITCHEN2
Reviewer		Order	H001969
Approves		Date	02/09/2025

RF_KS_DPLT_600-600X9X100

Colour

05.107=ML.TONIC#MD716 (EVELYN)

05.01=ML WHITE VM1012 18/18

Edge

01.344=1 MD716

01.47=1 WHITE



K1L-160169808

K4L-160169819

K1R-160174721

K2L-160174732

K3R-160174741

K5R-160174753

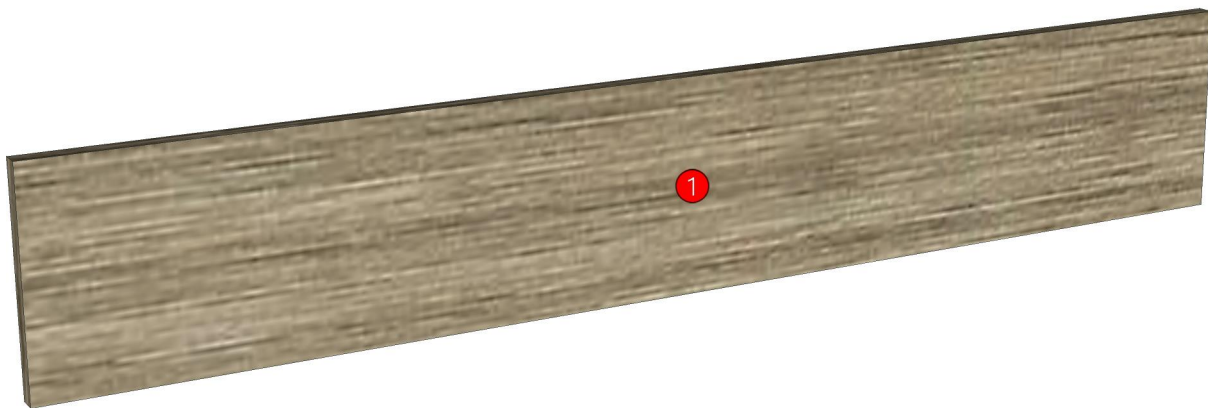

Model	RF_KS_DPLT_600		
Creator	CHALEAMPHON	.BCP Name	INDEX_C3D_KITCHEN2
Reviewer		Order	H001969
Approves		Date	02/09/2025

No.	Article No.	Description	Mat	Dimension	Cutting Size	Typepology	Skin
0	RF_KS_DPLT_600			600x100x9			
	RF_KS_DPLT_600-01	LED BOTTOM	PB-ST	9x100x600	9X98X598;L2:W2	183000_STR=05.107_EDG=MD716-1	2

Model	RF_KS_DW65		
Creator	CHALEAMPHON	.BCP Name	INDEX_C3D_KITCHEN2
Reviewer		Order	H002221
Approves		Date	09/01/2026

RF_KS_DW65-650X300X600

Colour

05.107=ML.TONIC#MD716 (EVELYN)

05.01=ML WHITE VM1012 18/18

Edge

01.344=1 MD716

01.47=1 WHITE



K3R-160174741

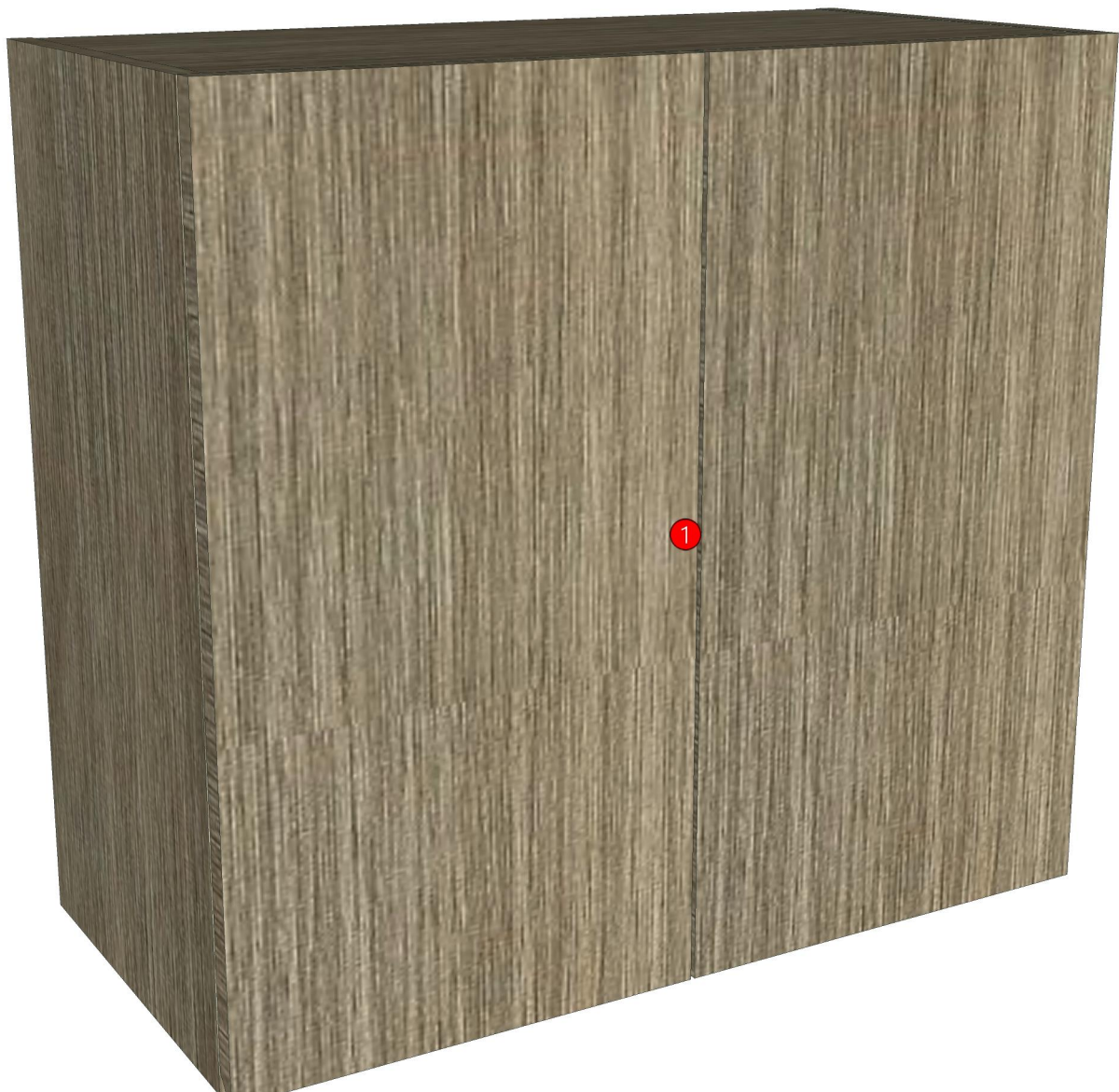

Model	-		
Creator	CHALEAMPON	.BCP Name	INDEX_C3D_KITCHEN2
Reviewer		Order	H002221
Approves		Date	09/01/2026

