

<b>Model</b>	RHYTHM_CN_DBH602(S)N		
<b>Creator</b>	CHALEAMPHON	<b>.BCP Name</b>	INDEX_C3D_KITCHEN2
<b>Reviewer</b>		<b>Order</b>	H001365
<b>Approves</b>		<b>Date</b>	12/12/2024

## RHYTHM\_CN\_DBH602(S)N-600X570X785

**Colour**

05.68=ML.BROWN NORDIC#BT1 (MATT WOODGRAIN)  
20.04=ML.SANDSTONE#073 \_PEARL

**Edge**

01.381=1 ML.BROWN NORDIC BT1  
01.155=1 SANDSTONE (P7-500M1)

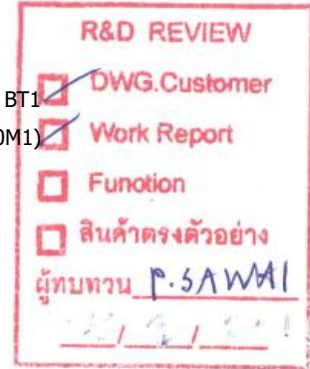

- K101R-160151571
- K102L-160151586
- K102R-160151600
- K103L-160151614
- K104L-160151629
- K208L-160151655
- K100R-160158666
- K103R-160158679
- K105L-160158694
- K104R-160168861
- K1001L-160168916
- K1001R-160168930
- K1002R-160168888
- K1003R-160168901
- K1004L-160168944
- K1004R-160168959
- K1006R-160169004
- K200L-160171928
- K200R-160171841
- K201L-160171854
- K201R-160171868
- K202R-160171882
- K204L-160171896
- K204R-160171906
- K205R-160171916
- K209L-160171949

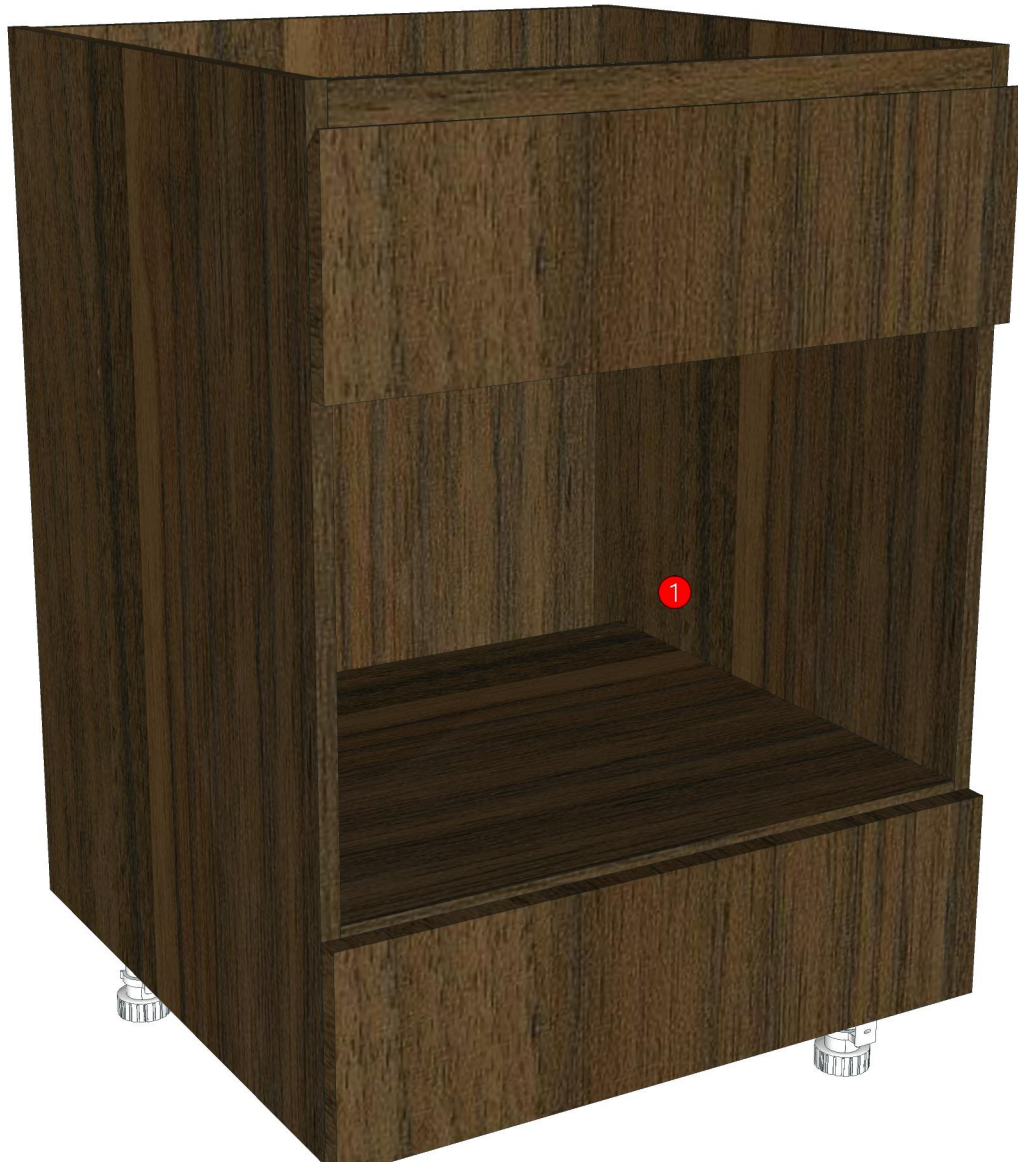

<b>Model</b>	-RHYTHM_CN		
<b>Creator</b>	CHALEAMPHON	<b>.BCP Name</b>	INDEX_C3D_KITCHEN2
<b>Reviewer</b>		<b>Order</b>	H001365
<b>Approves</b>		<b>Date</b>	12/12/2024

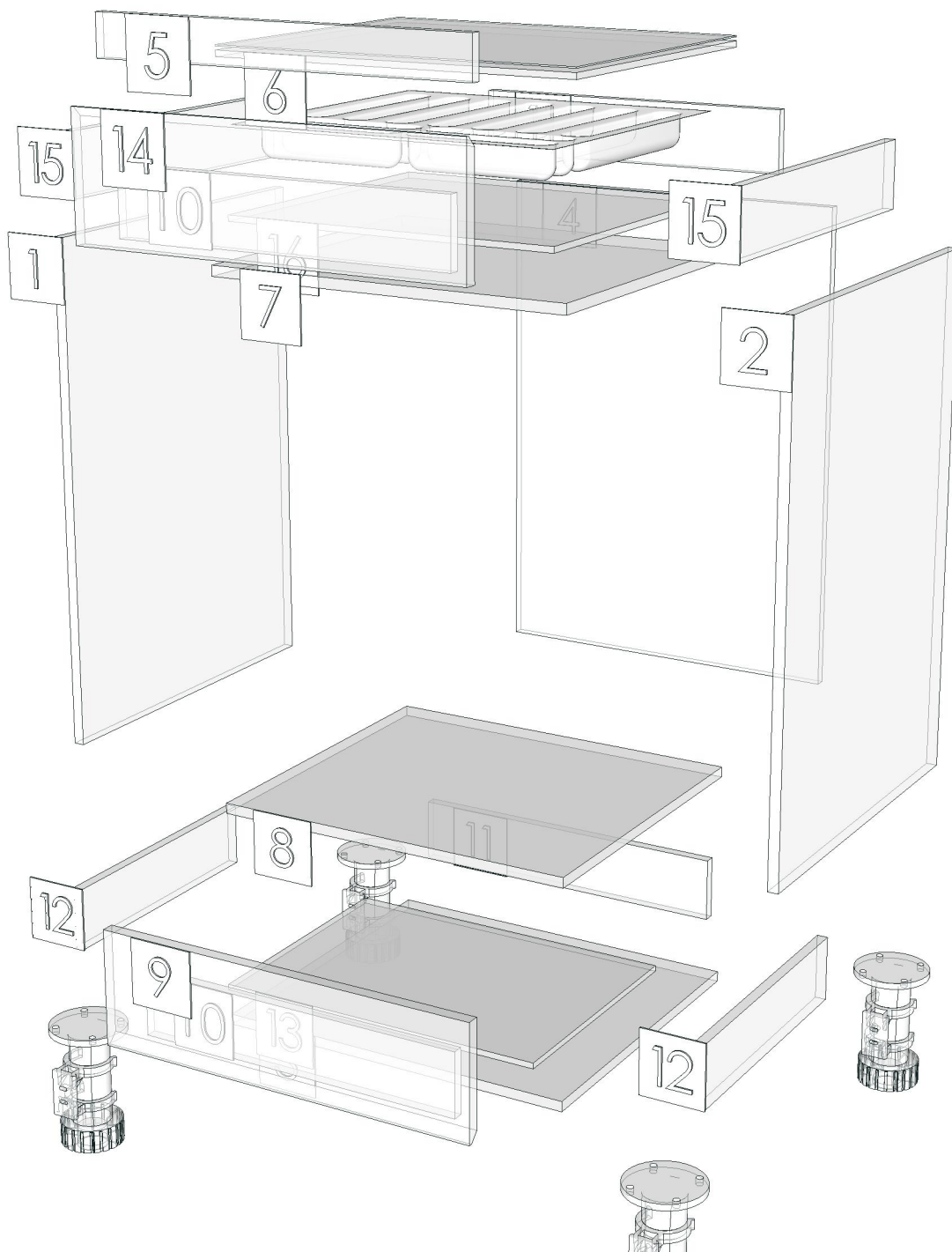

<b>Model</b>	RHYTHM_CN_DBS55R(GL)N		
<b>Creator</b>	CHALEAMPHON	<b>.BCP Name</b>	INDEX_C3D_KITCHEN2
<b>Reviewer</b>		<b>Order</b>	H001370
<b>Approves</b>		<b>Date</b>	13/12/2024

## **RHYTHM\_CN\_DBS55R(GL)N-550X570X785**

### **Colour**

05.68=ML.BROWN NORDIC#BT1 (MATT WOODGRAIN)  
20.04=ML.SANDSTONE#073\_PEARL

### **Edge**

01.381=1 ML.BROWN NORDIC BT1  
01.155=1 SANDSTONE (P7-500M1)

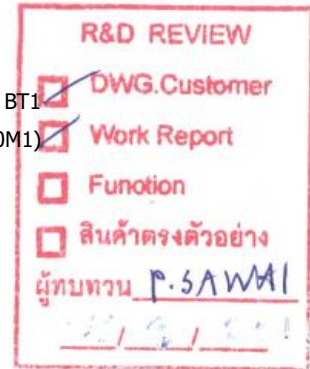

- K102R-160151600
- K100R-160158666
- K1001R-160168930
- K1002R-160168888
- K200R-160171841
- K201R-160171868
- K202R-160171882

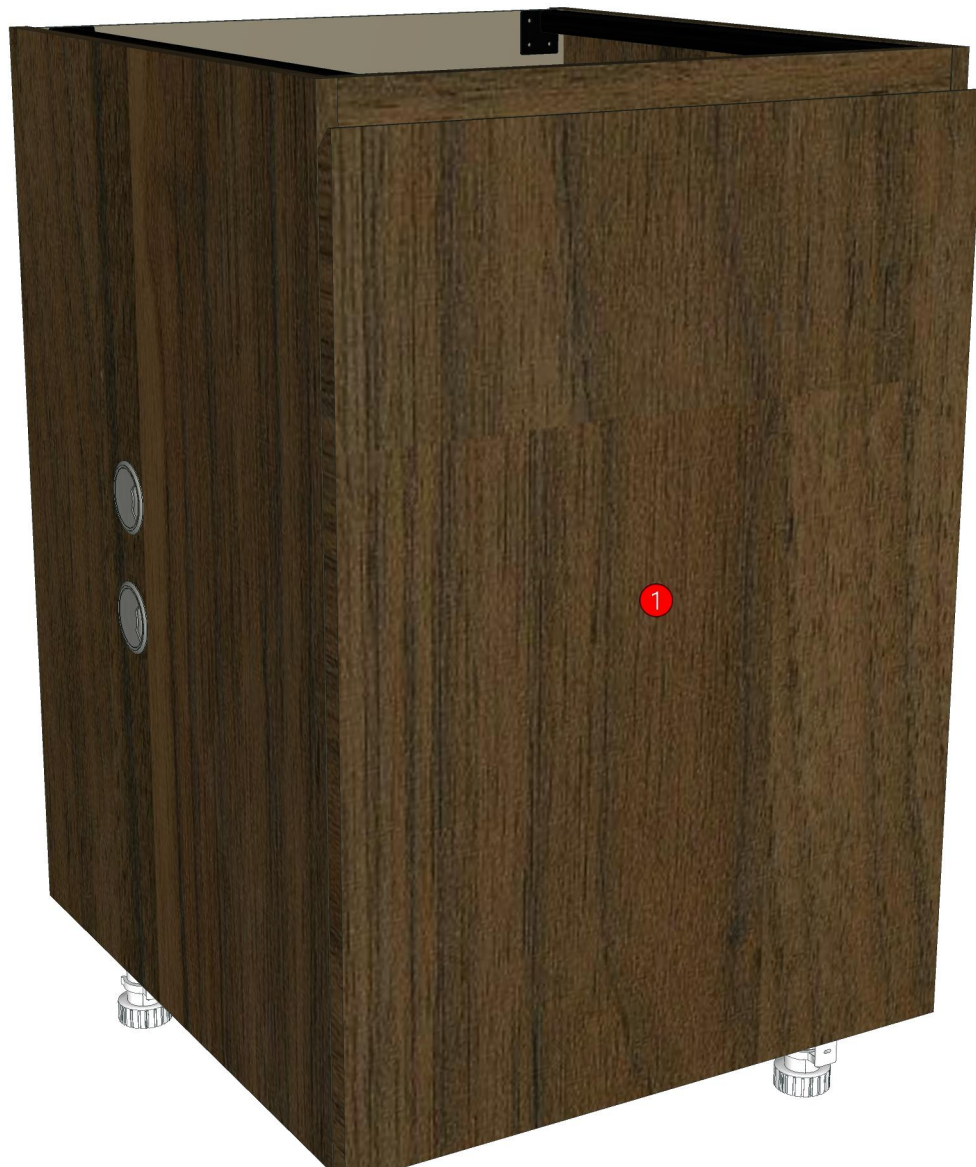

<b>Model</b>	-RHYTHM_CN		
<b>Creator</b>	CHALEAMPHON	<b>.BCP Name</b>	INDEX_C3D_KITCHEN2
<b>Reviewer</b>		<b>Order</b>	H001370
<b>Approves</b>		<b>Date</b>	13/12/2024

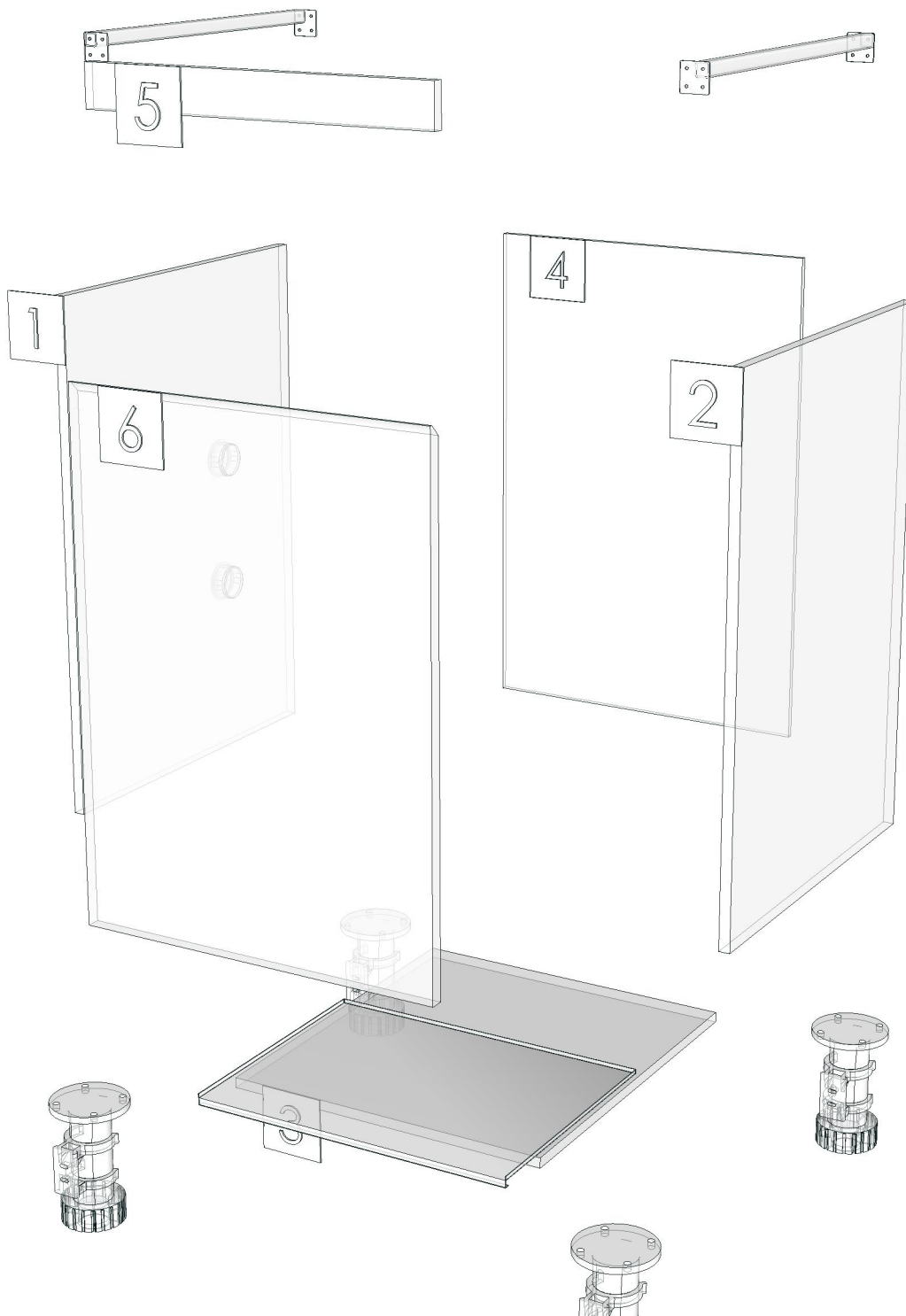

<b>Model</b>	RHYTHM_CN_DDM_1798C		
<b>Creator</b>	CHALEAMPHON	<b>.BCP Name</b>	INDEX_C3D_KITCHEN2
<b>Reviewer</b>		<b>Order</b>	H001982
<b>Approves</b>		<b>Date</b>	09/09/2025

## **RHYTHM\_CN\_DDM\_1798C-1798X6X600**

**Colour**

03.13=PVC WHITE#630 T0.15MM.

**Edge**

<b>R&amp;D REVIEW</b>	
<input checked="" type="checkbox"/>	DWG.Customer
<input checked="" type="checkbox"/>	Work Report
<input type="checkbox"/>	Function
<input type="checkbox"/>	สินค้าตรงตัวอย่าง
ผู้ทบทวน <u>P.SAWAI</u>	
<u>22/9/25</u>	

K1002R-160168888

K200L-160171828

K200R-160171941

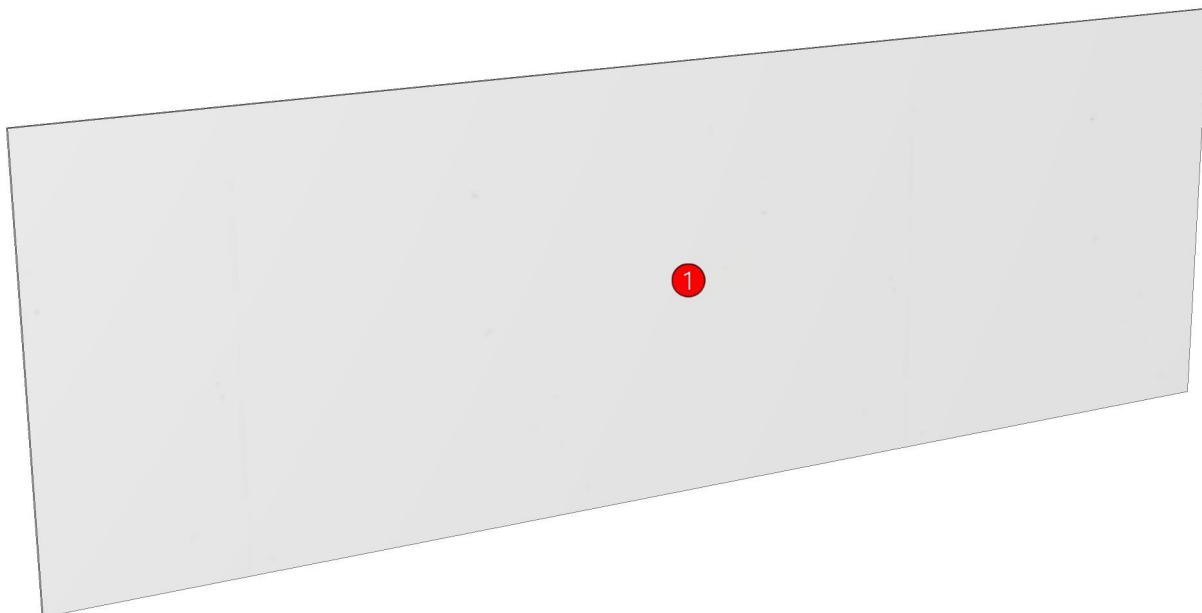

<b>Model</b>	RHYTHM_CN_DDM_1798C		
<b>Creator</b>	CHALEAMPHON	<b>.BCP Name</b>	INDEX_C3D_KITCHEN2
<b>Reviewer</b>		<b>Order</b>	H001982
<b>Approves</b>		<b>Date</b>	09/09/2025

No.	Article No.	Description	Mat	Dimension	Cutting Size	Typepology	Skin
0	RHYTHM_CN_DDM_1798C			1798x600x6			
	RHYTHM_CN_DDM_1798C-01	WALL MOUNT	MDF-ST	6x600x1798	6X600X1798;NO EDGE	183000_STR=03.13_EDG=-	2

<b>Model</b>	RHYTHM_CN_DFCL_1800H1		
<b>Creator</b>	CHALEAMPON	<b>.BCP Name</b>	INDEX_C3D_KITCHEN2
<b>Reviewer</b>		<b>Order</b>	H002126
<b>Approves</b>		<b>Date</b>	13/11/2025

## RHYTHM\_CN\_DFCL\_1800H1-1800X16X105

**Colour**

20.04=ML.SANDSTONE#073\_PEARL

**Edge**

01.155=1 SANDSTONE (P7-500M1)

<b>R&amp;D REVIEW</b>	
<input checked="" type="checkbox"/>	DWG.Customer
<input checked="" type="checkbox"/>	Work Report
<input type="checkbox"/>	Function
<input type="checkbox"/>	สินค้าตรงตัวอย่าง
ผู้ทบทวน <u>P.SAWAI</u>	
<u>22/11/25</u>	

K200L-160171828

K200R-160171841

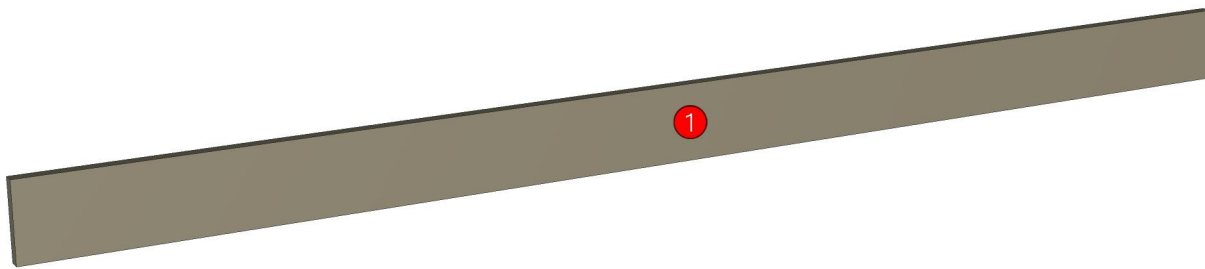

<b>Model</b>	RHYTHM_CN_DFCL_1800H1		
<b>Creator</b>	CHALEAMPHON	<b>.BCP Name</b>	INDEX_C3D_KITCHEN2
<b>Reviewer</b>		<b>Order</b>	H002126
<b>Approves</b>		<b>Date</b>	13/11/2025

No.	Article No.	Description	Mat	Dimension	Cutting Size	Typepology	Skin
0	RHYTHM_CN_DFCL_1800H1			1800x105x16			
	RHYTHM_CN_DFCL_1800H1-02	FILLER FRONT	PB-ST	16x105x1800	16X104X1798;L1:W2	183000_STR=20.04_EDG=SANDSTONE073-1	2

<b>Model</b>	RHYTHM_CN_DFCL_300H1		
<b>Creator</b>	CHALEAMPHON	<b>.BCP Name</b>	INDEX_C3D_KITCHEN2
<b>Reviewer</b>		<b>Order</b>	H001393
<b>Approves</b>		<b>Date</b>	19/12/2024

## **RHYTHM\_CN\_DFCL\_300H1-300X16X105**

**Colour**

20.04=ML.SANDSTONE#073\_PEARL

**Edge**

01.155=1 SANDSTONE (P7-500M1)

<b>R&amp;D REVIEW</b>	
<input checked="" type="checkbox"/>	DWG.Customer
<input checked="" type="checkbox"/>	Work Report
<input type="checkbox"/>	Function
<input type="checkbox"/>	สินค้าตรงตัวอย่าง
ผู้ทบทวน <u>P.SAWAI</u>	
<u>22/12/24</u>	

- K208L-160151655
- K200L-160171828
- K200R-160171841
- K201L-160171854
- K201R-160171868
- K204L-160171896
- K204R-160171906

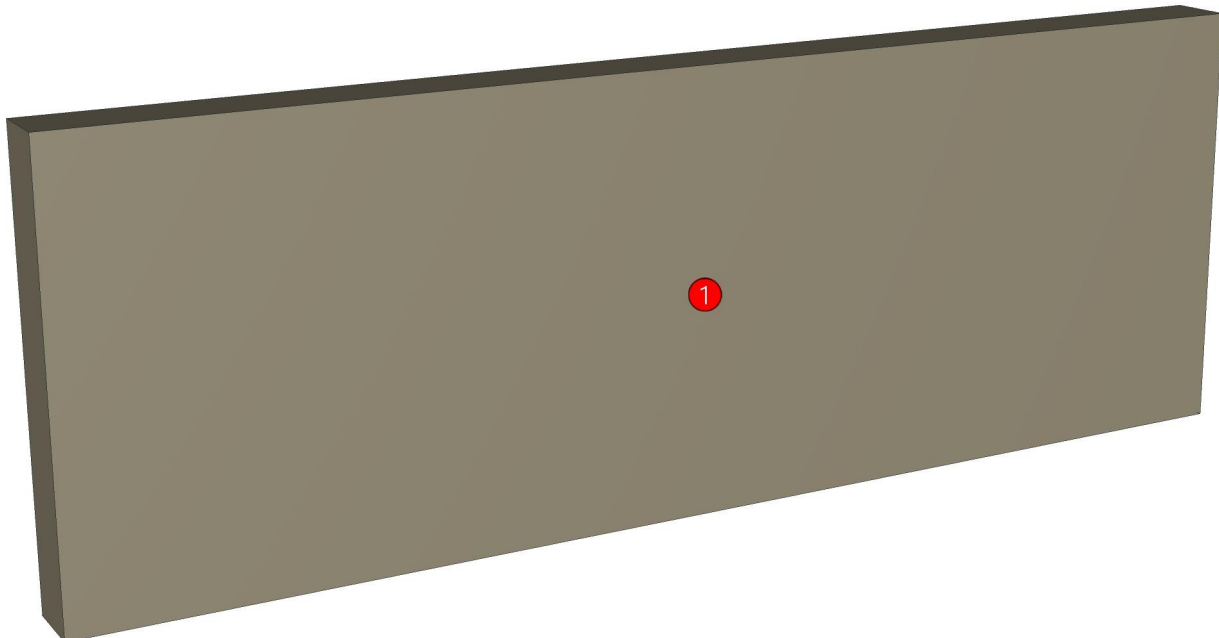

<b>Model</b>	RHYTHM_CN_DFCL_300H1		
<b>Creator</b>	CHALEAMPHON	<b>.BCP Name</b>	INDEX_C3D_KITCHEN2
<b>Reviewer</b>		<b>Order</b>	H001393
<b>Approves</b>		<b>Date</b>	19/12/2024

No.	Article No.	Description	Mat	Dimension	Cutting Size	Typepology	Skin
0	RHYTHM_CN_DFCL_300H1			300x105x16			
	RHYTHM_CN_DFCL_300H1-01	FILLER TOP	PB-ST	16x105x300	16X104X299;L1:W1	183000_STR=20.04_EDG=SANDSTONE073-1	2

<b>Model</b>	RHYTHM_CN_DFLR_650		
<b>Creator</b>	CHALEAMPHON	<b>.BCP Name</b>	INDEX_C3D_KITCHEN2
<b>Reviewer</b>		<b>Order</b>	H001391
<b>Approves</b>		<b>Date</b>	19/12/2024

## **RHYTHM\_CN\_DFLR\_650-650X570X16**

### **Colour**

05.68=ML.BROWN NORDIC#BT1 (MATT WOODGRAIN)  
20.04=ML.SANDSTONE#073\_PEARL

### **Edge**

01.381=1 ML.BROWN NORDIC BT1  
01.155=1 SANDSTONE (P7-500M1)

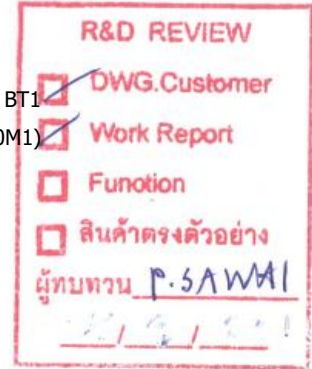

- K102L-160151586
- K102R-160151600
- K100R-160158666
- K1001L-160168916
- K1001R-160168930
- K1002R-160168888
- K200L-160171828
- K200R-160171841
- K201L-160171854
- K201R-160171868
- K202R-160171882



<b>Model</b>	RHYTHM_CN_DFLR_650		
<b>Creator</b>	CHALEAMPON	<b>.BCP Name</b>	INDEX_C3D_KITCHEN2
<b>Reviewer</b>		<b>Order</b>	H001391
<b>Approves</b>		<b>Date</b>	19/12/2024

No.	Article No.	Description	Mat	Dimension	Cutting Size	Typepology	Skin
0	RHYTHM_CN_DFLR_650			650x16x570			
	RHYTHM_CN_DFLR_650-01	CLOSE TOP	PB-ST	16x570x650	16X568X650;L2:W0	182000_STR=05.68_EDG=BT1-1	2

<b>Model</b>	RHYTHM_CN_DL60(H1)R		
<b>Creator</b>	CHALEAMPHON	<b>.BCP Name</b>	INDEX_C3D_KITCHEN2
<b>Reviewer</b>		<b>Order</b>	H002115
<b>Approves</b>		<b>Date</b>	12/11/2025

## **RHYTHM\_CN\_DL60(H1)R-600X300X500**

### **Colour**

05.68=ML.BROWN NORDIC#BT1 (MATT WOODGRAIN)  
20.04=ML.SANDSTONE#073 \_PEARL

### **Edge**

01.381=1 ML.BROWN NORDIC BT1  
01.155=1 SANDSTONE (P7-500M1)

<b>R&amp;D REVIEW</b>	
<input checked="" type="checkbox"/>	DWG.Customer
<input checked="" type="checkbox"/>	Work Report
<input type="checkbox"/>	Function
<input type="checkbox"/>	สินค้าตรงตัวอย่าง
ผู้ทบทวน <u>P.SAWAI</u>	
<u>22/11/25</u>	

K200L-160171828  
K201L-160171854  
K204R-160171906

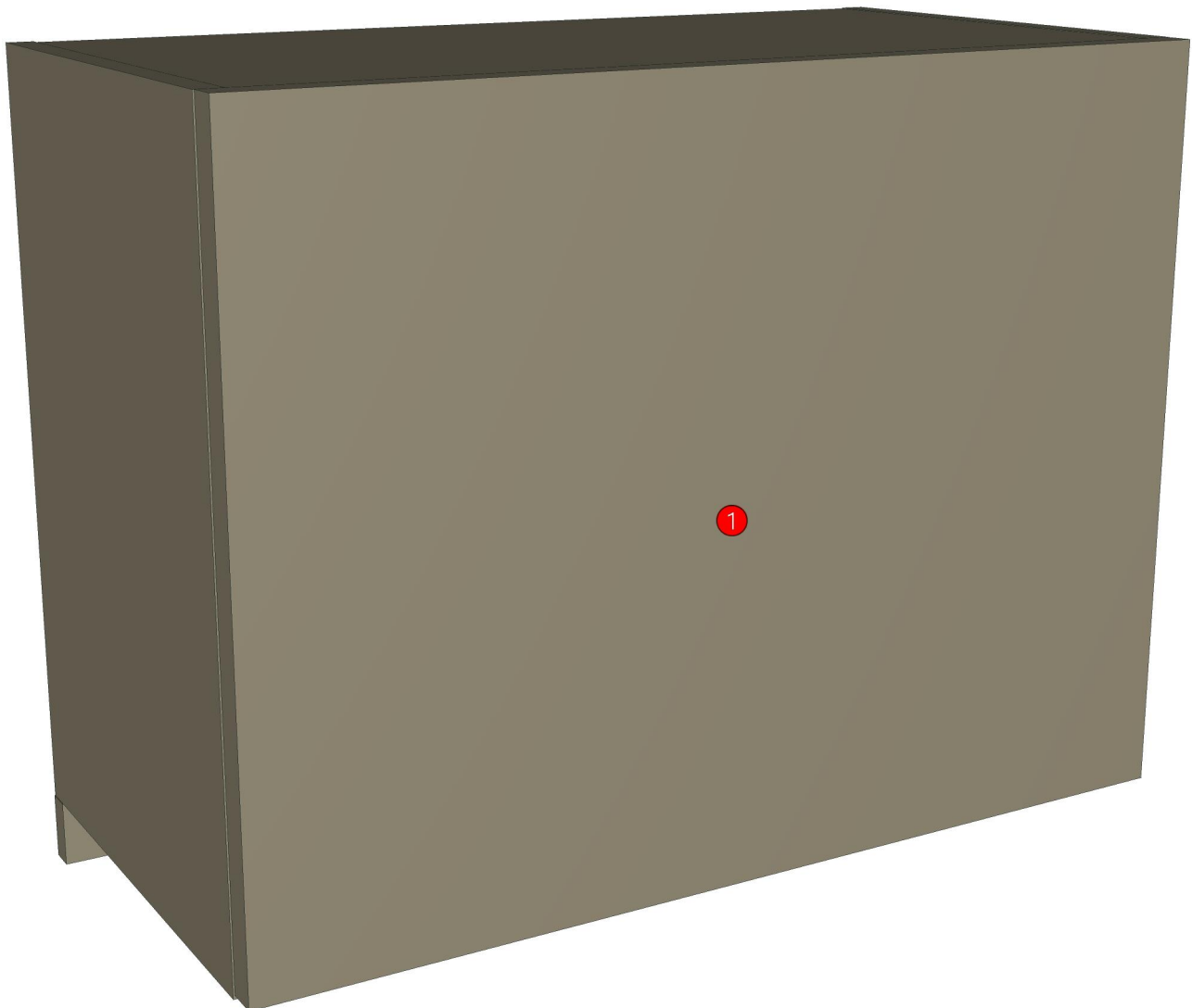

<b>Model</b>	-		
<b>Creator</b>	CHALEAMPHON	<b>.BCP Name</b>	INDEX_C3D_KITCHEN2
<b>Reviewer</b>		<b>Order</b>	H002115
<b>Approves</b>		<b>Date</b>	12/11/2025

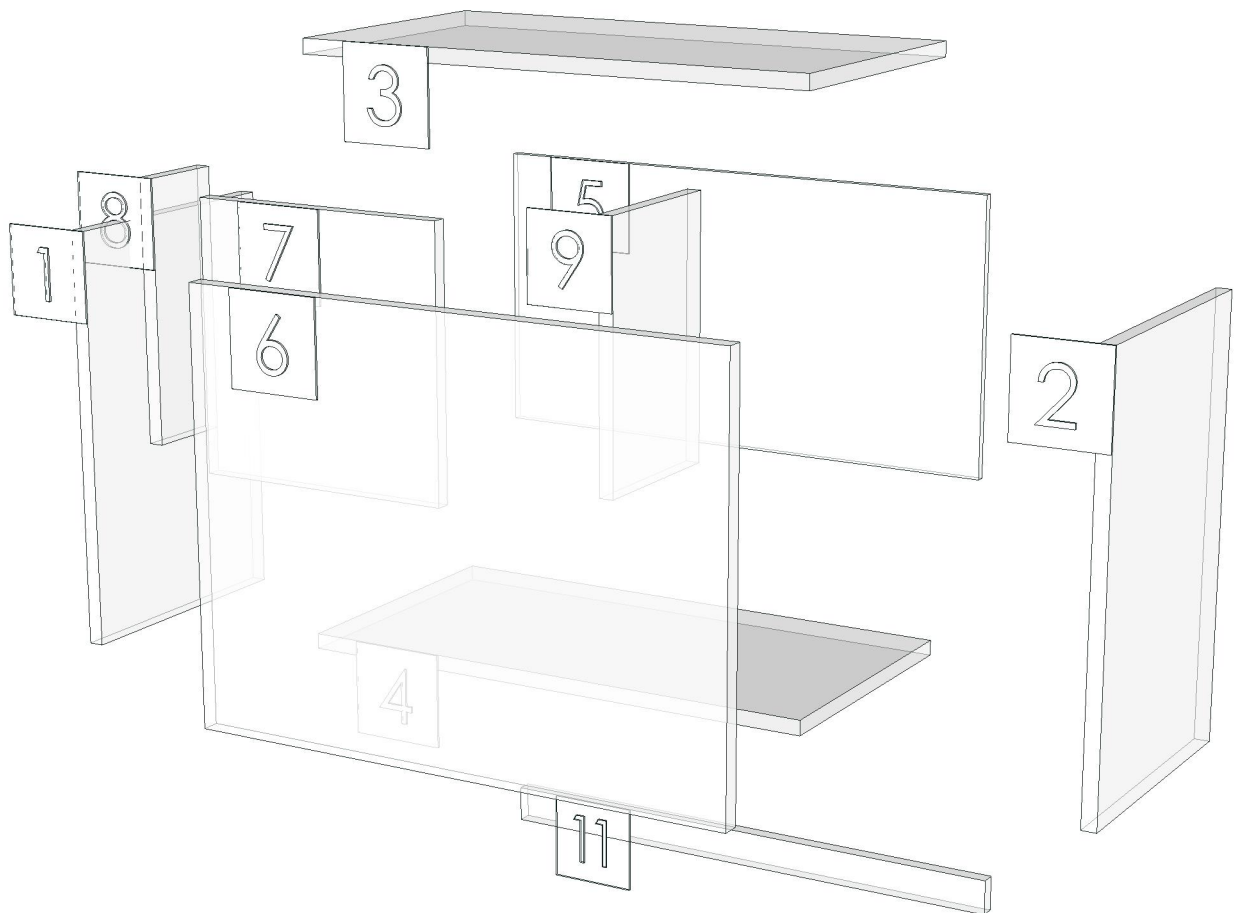

<b>Model</b>	RHYTHM_CN_DL60L(LH1)		
<b>Creator</b>	CHALEAMPHON	<b>.BCP Name</b>	INDEX_C3D_KITCHEN2
<b>Reviewer</b>		<b>Order</b>	H002116
<b>Approves</b>		<b>Date</b>	12/11/2025

## **RHYTHM\_CN\_DL60L(LH1)-600X300X500**

### **Colour**

05.68=ML.BROWN NORDIC#BT1 (MATT WOODGRAIN)  
20.04=ML.SANDSTONE#073\_PEARL

### **Edge**

01.381=1 ML.BROWN NORDIC BT1  
01.155=1 SANDSTONE (P7-500M1)

<b>R&amp;D REVIEW</b>	
<input checked="" type="checkbox"/>	DWG.Customer
<input checked="" type="checkbox"/>	Work Report
<input type="checkbox"/>	Function
<input type="checkbox"/>	สินค้าตรงตัวอย่าง
ผู้ทบทวน <u>P.SAWAI</u>	
<u>22/11/25</u>	

K200L-160171828  
K200R-160171841  
K201L-160171854  
K201R-160171868  
K202R-160171882

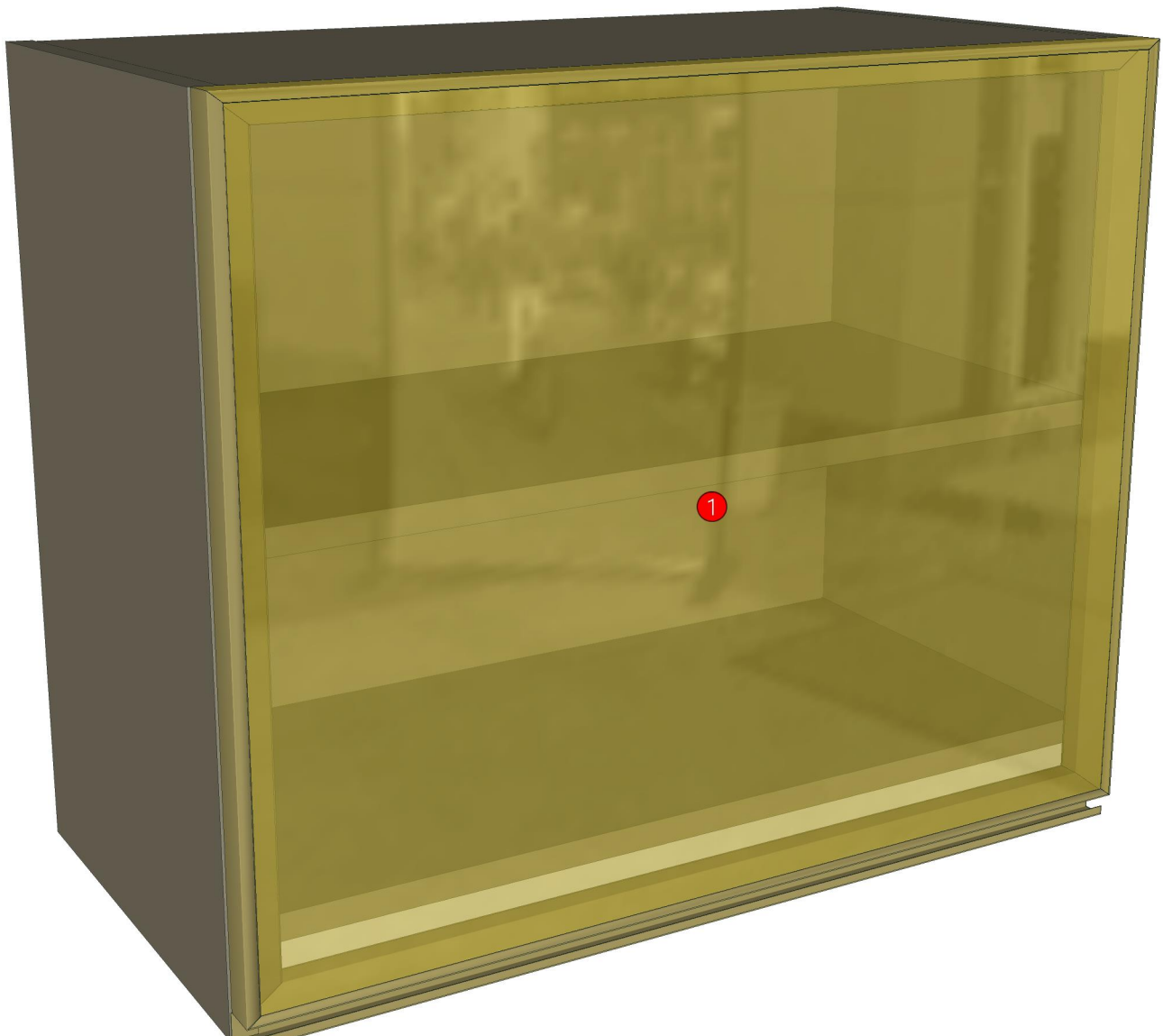

<b>Model</b>	-		
<b>Creator</b>	CHALEAMPON	<b>.BCP Name</b>	INDEX_C3D_KITCHEN2
<b>Reviewer</b>		<b>Order</b>	H002116
<b>Approves</b>		<b>Date</b>	12/11/2025

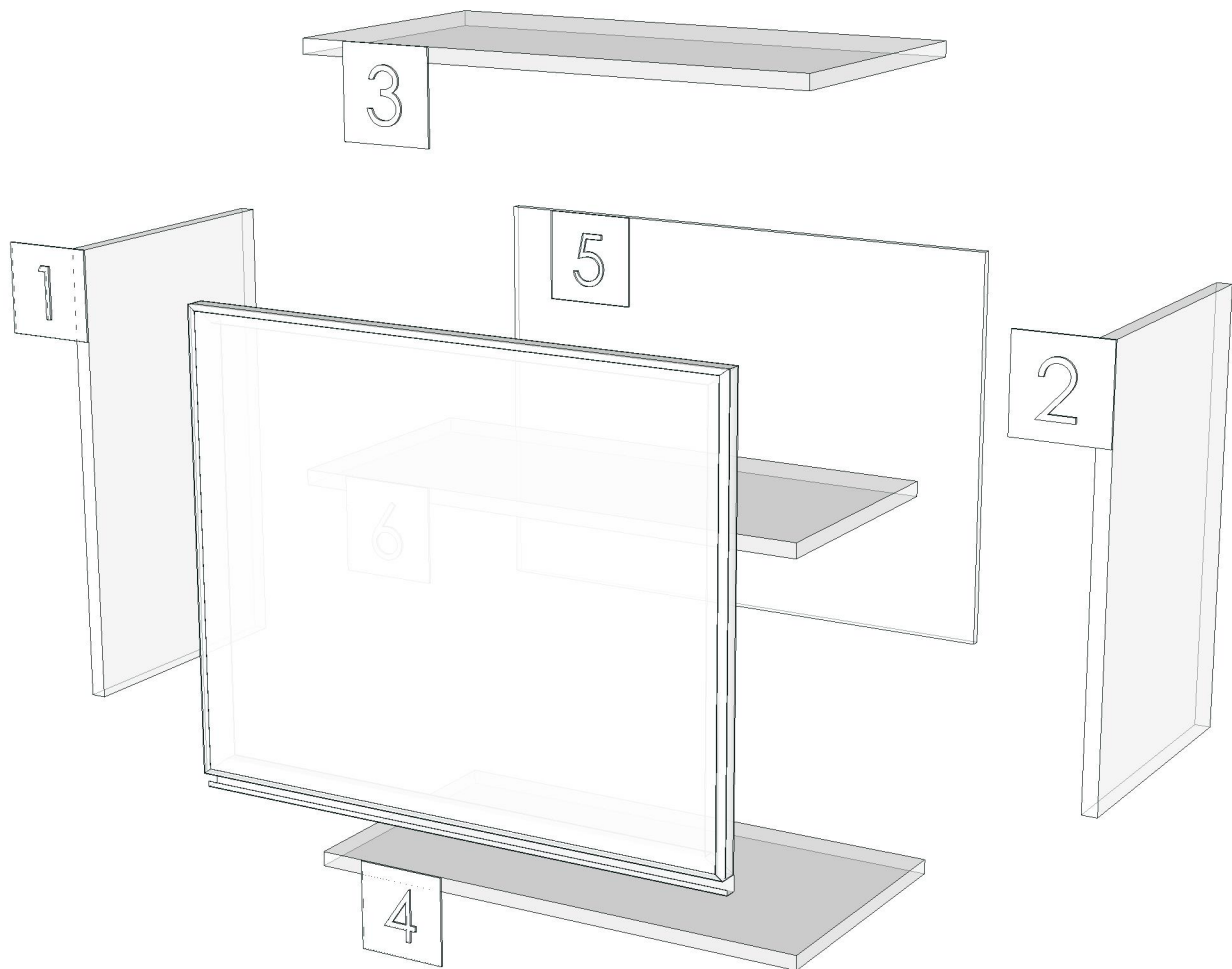

<b>Model</b>	RHYTHM_CN_DL60R(RH1)		
<b>Creator</b>	CHALEAMPON	<b>.BCP Name</b>	INDEX_C3D_KITCHEN2
<b>Reviewer</b>		<b>Order</b>	H002117
<b>Approves</b>		<b>Date</b>	12/11/2025

## **RHYTHM\_CN\_DL60R(RH1)-600X300X500**

### **Colour**

05.68=ML.BROWN NORDIC#BT1 (MATT WOODGRAIN)  
20.04=ML.SANDSTONE#073\_PEARL

### **Edge**

01.381=1 ML.BROWN NORDIC BT1  
01.155=1 SANDSTONE (P7-500M1)

<b>R&amp;D REVIEW</b>	
<input checked="" type="checkbox"/>	DWG.Customer
<input checked="" type="checkbox"/>	Work Report
<input type="checkbox"/>	Function
<input type="checkbox"/>	สินค้าตรงตัวอย่าง
ผู้ทบทวน <u>P.SAWAI</u>	
<u>22/11/25</u>	

K200L-160171828  
K200R-160171841  
K201L-160171854  
K201R-160171868  
K202R-160171882

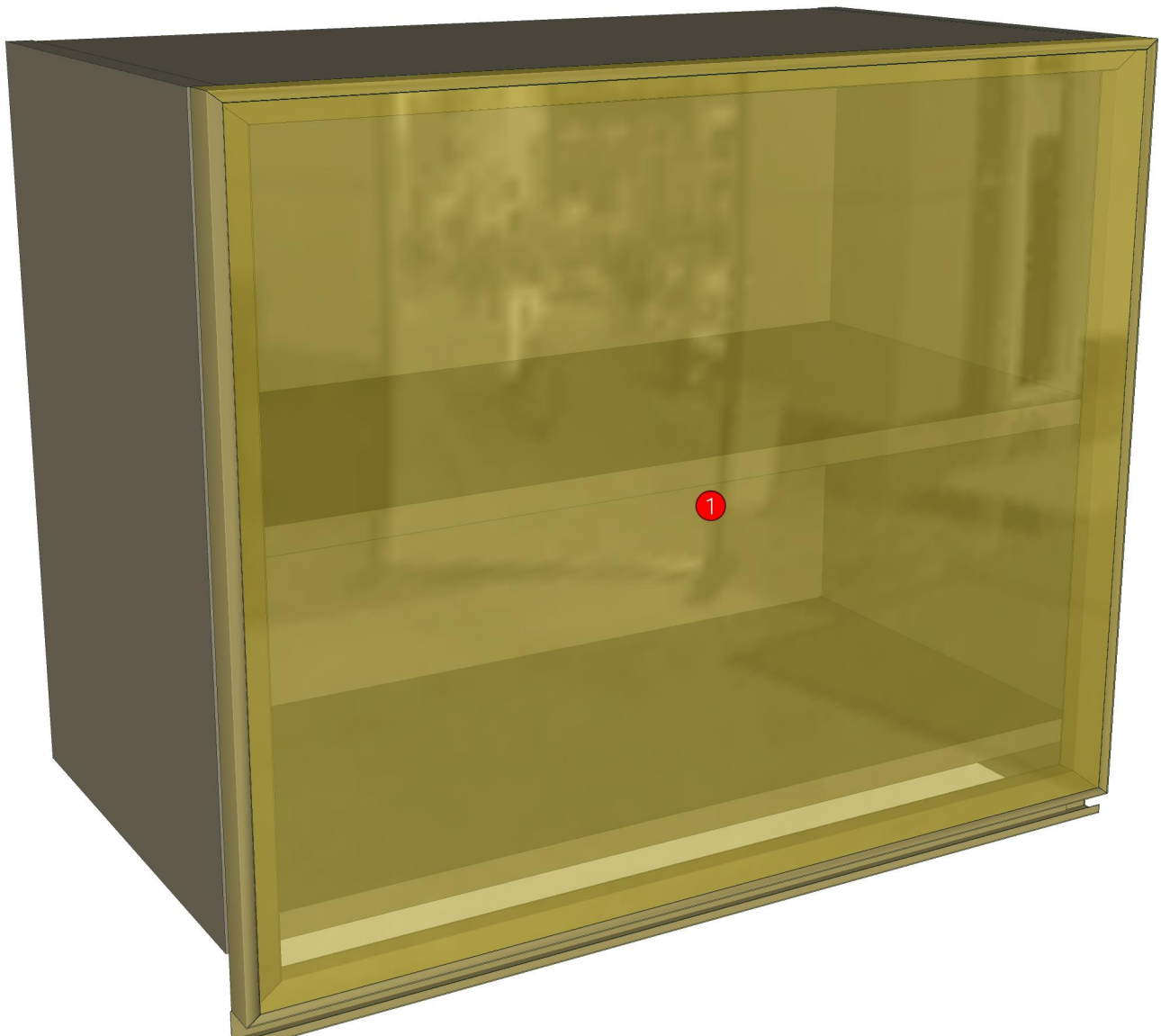

<b>Model</b>	-		
<b>Creator</b>	CHALEAMPON	<b>.BCP Name</b>	INDEX_C3D_KITCHEN2
<b>Reviewer</b>		<b>Order</b>	H002117
<b>Approves</b>		<b>Date</b>	12/11/2025

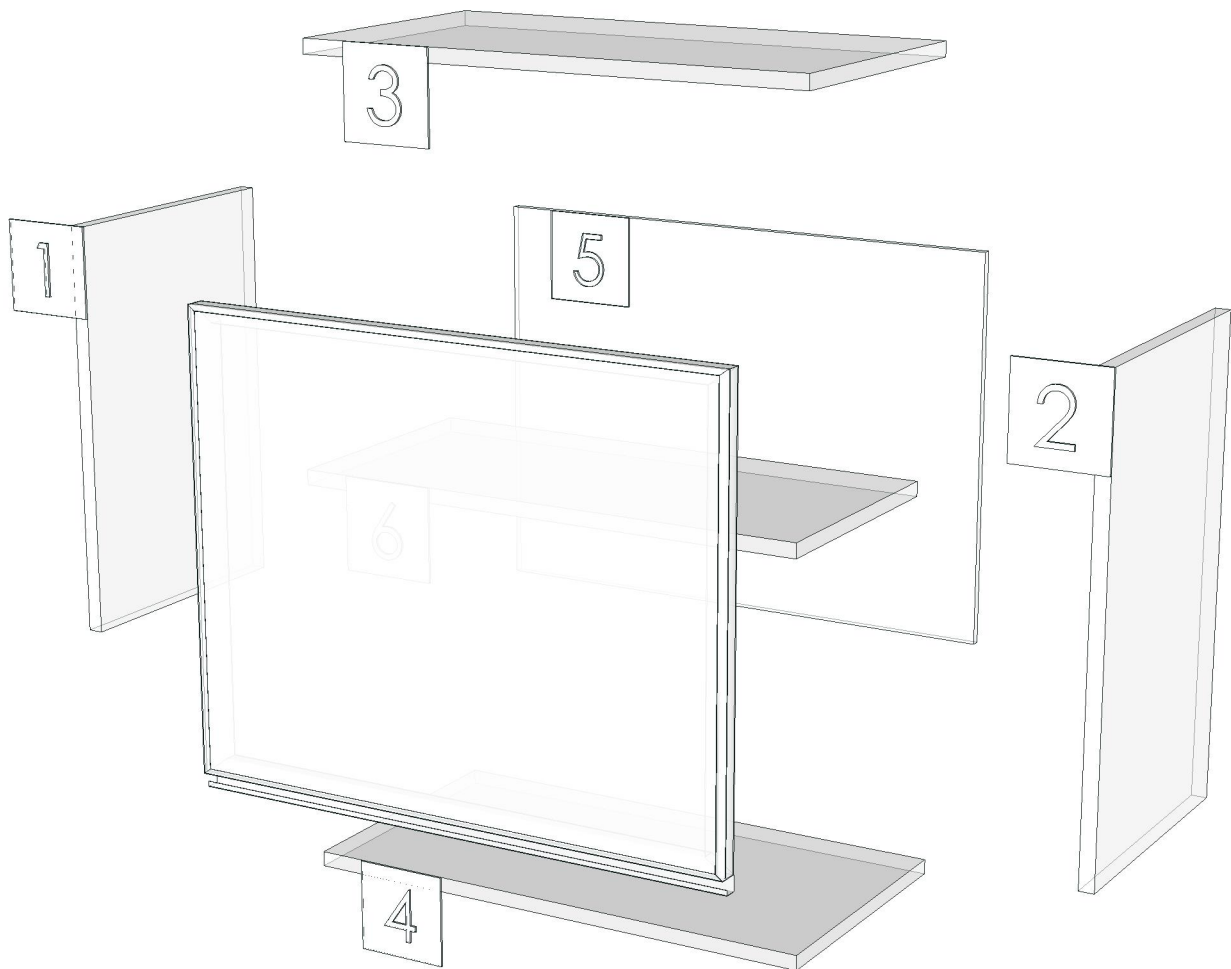

<b>Model</b>	RHYTHM_CN_DPLT_550N		
<b>Creator</b>	CHALEAMPHON	<b>.BCP Name</b>	INDEX_C3D_KITCHEN2
<b>Reviewer</b>		<b>Order</b>	H001405
<b>Approves</b>		<b>Date</b>	19/12/2024

## **RHYTHM\_CN\_DPLT\_550N-550X9X100**

**Colour**

05.68=ML.BROWN NORDIC#BT1 (MATT WOODGRAIN)

**Edge**

01.381=1 ML.BROWN NORDIC BT1

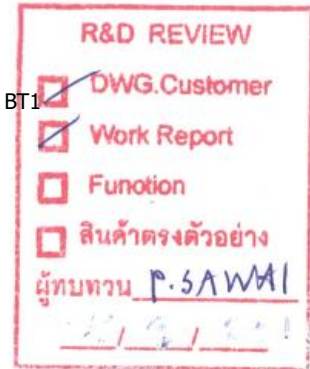

- K102L-160151586
- K102R-160151600
- K100R-160158666
- K1001L-160168916
- K1001R-160168930
- K1002R-160168888
- K200L-160171828
- K200R-160171841
- K201L-160171854
- K201R-160171868

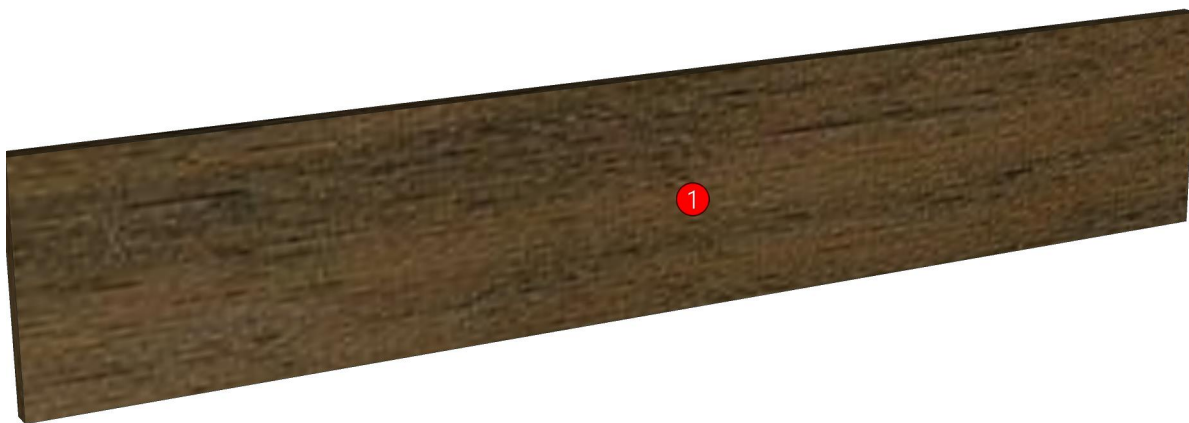

<b>Model</b>	RHYTHM_CN_DPLT_550N		
<b>Creator</b>	CHALEAMPHON	<b>.BCP Name</b>	INDEX_C3D_KITCHEN2
<b>Reviewer</b>		<b>Order</b>	H001405
<b>Approves</b>		<b>Date</b>	19/12/2024

No.	Article No.	Description	Mat	Dimension	Cutting Size	Typepology	Skin
0	RHYTHM_CN_DPLT_550N			550x100x9			
	RHYTHM_CN_DPLT_550N-02	LED BOTTOM	PB-ST	9x100x550	9X98X548;L2:W2	183000_STR=05.68_EDG=BT1-1	2

<b>Model</b>	RHYTHM_CN_DPLT_600G		
<b>Creator</b>	CHALEAMPON	<b>.BCP Name</b>	INDEX_C3D_KITCHEN2
<b>Reviewer</b>		<b>Order</b>	H001615
<b>Approves</b>		<b>Date</b>	19/03/2025

## RHYTHM\_CN\_DPLT\_600G-600X9X100

**Colour**

05.68=ML.BROWN NORDIC#BT1 (MATT WOODGRAIN)

**Edge**

01.381=1 ML.BROWN NORDIC BT1

<b>R&amp;D REVIEW</b>	
<input checked="" type="checkbox"/>	DWG.Customer
<input checked="" type="checkbox"/>	Work Report
<input type="checkbox"/>	Function
<input type="checkbox"/>	สินค้าตรงตัวอย่าง
ผู้ทบทวน <u>P.SAWAI</u>	
<u>22/3/25</u>	

K100R-160158666  
K1002R-160168888  
K200L-160171828  
K200R-160171841

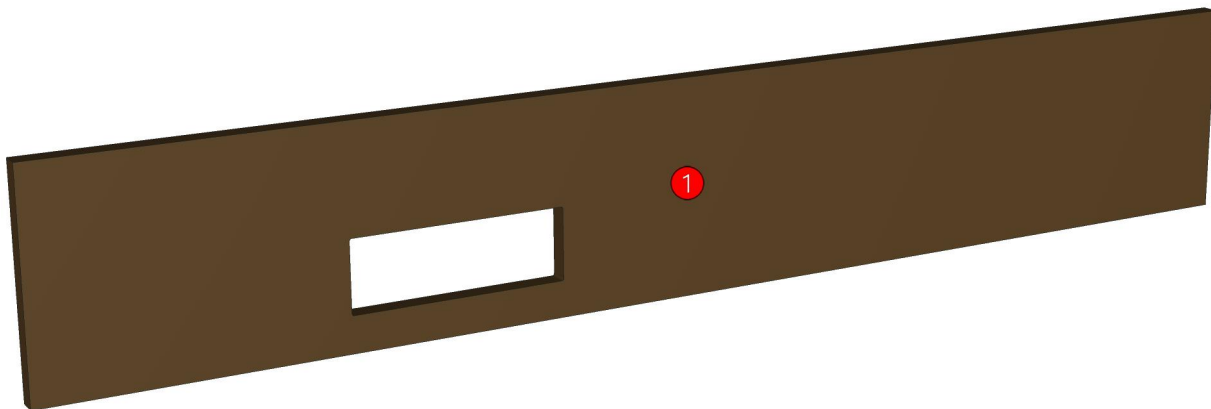

<b>Model</b>	RHYTHM_CN_DPLT_600G		
<b>Creator</b>	CHALEAMPHON	<b>.BCP Name</b>	INDEX_C3D_KITCHEN2
<b>Reviewer</b>		<b>Order</b>	H001615
<b>Approves</b>		<b>Date</b>	19/03/2025

No.	Article No.	Description	Mat	Dimension	Cutting Size	Typepology	Skin
0	RHYTHM_CN_DPLT_600G			600x100x9			
	RHYTHM_CN_DPLT_600G-01	LED BOTTOM	PB-ST	9x100x600	9X98X599;L2:W1	183000_STR=05.68_EDG=BT1-1	2

<b>Model</b>	RHYTHM_CN_DPLT_600N		
<b>Creator</b>	CHALEAMPHON	<b>.BCP Name</b>	INDEX_C3D_KITCHEN2
<b>Reviewer</b>		<b>Order</b>	H001406
<b>Approves</b>		<b>Date</b>	19/12/2024

## RHYTHM\_CN\_DPLT\_600N-600X9X100

**Colour**

05.68=ML.BROWN NORDIC#BT1 (MATT WOODGRAIN)

**Edge**

01.381=1 ML.BROWN NORDIC BT1

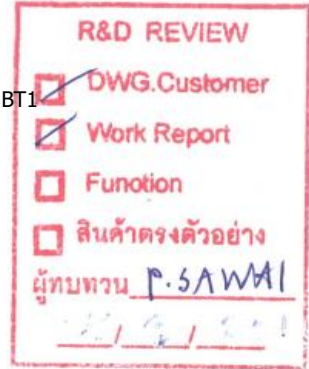

- K101R-160151571
- K102L-160151586
- K102R-160151600
- K103L-160151614
- K104L-160151629
- K208L-160151655
- K100R-160158666
- K103R-160158679
- K105L-160158694
- K104R-160168861
- K1001L-160168916
- K1001R-160168930
- K1002R-160168888
- K1003R-160168901
- K1004L-160168944
- K1004R-160168959
- K1005L-160168974
- K1005R-160168989
- K1006R-160169004
- K200L-160171828
- K200R-160171841
- K201L-160171854
- K201R-160171868
- K202R-160171882
- K204L-160171896
- K204R-160171906
- K205R-160171916
- K209L-160171949



<b>Model</b>	RHYTHM_CN_DPLT_600N		
<b>Creator</b>	CHALEAMPHON	<b>.BCP Name</b>	INDEX_C3D_KITCHEN2
<b>Reviewer</b>		<b>Order</b>	H001406
<b>Approves</b>		<b>Date</b>	19/12/2024

No.	Article No.	Description	Mat	Dimension	Cutting Size	Typepology	Skin
0	RHYTHM_CN_DPLT_600N			600x100x9			
	RHYTHM_CN_DPLT_600N-01	LED BOTTOM	PB-ST	9x100x600	9X98X599;L2:W1	183000_STR=05.68_EDG=BT1-1	2

<b>Model</b>	RHYTHM_CN_DUT-1800N		
<b>Creator</b>	CHALEAMPON	<b>.BCP Name</b>	INDEX_C3D_KITCHEN2
<b>Reviewer</b>		<b>Order</b>	H001617
<b>Approves</b>		<b>Date</b>	19/03/2025

## **RHYTHM\_CN\_DUT-1800N-1800X60X25**

**Colour**

20.07=ML.WHITE #VM1012 18/18(MATT)

**Edge**

01.47=1 WHITE



- K100R-160158666
- K1002R-160168888
- K1006R-160169004
- K200L-160171828
- K200R-160171841

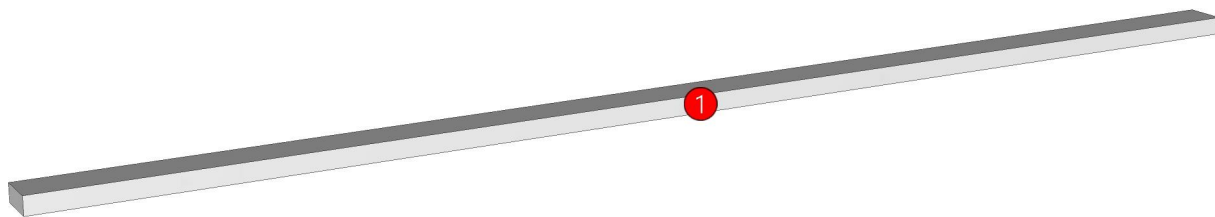

<b>Model</b>	RHYTHM_CN_DUT-1800N		
<b>Creator</b>	CHALEAMPHON	<b>.BCP Name</b>	INDEX_C3D_KITCHEN2
<b>Reviewer</b>		<b>Order</b>	H001617
<b>Approves</b>		<b>Date</b>	19/03/2025

No.	Article No.	Description	Mat	Dimension	Cutting Size	Typepology	Skin
0	RHYTHM_CN_DUT-1800N			1800x25x60			
	RHYTHM_CN_DUT-1800N-01	UNDER	PB-ST	25x60x1800	25X58X1800;L2:W0	182000 _STR=20.07 _EDG=WHITE-1	2

<b>Model</b>	RHYTHM_CN_DUT-500N		
<b>Creator</b>	CHALEAMPON	<b>.BCP Name</b>	INDEX_C3D_KITCHEN2
<b>Reviewer</b>		<b>Order</b>	H001413
<b>Approves</b>		<b>Date</b>	20/12/2024

## RHYTHM\_CN\_DUT-500N-500X60X25

**Colour**

20.07=ML.WHITE #VM1012 18/18(MATT)

**Edge**

01.47=1 WHITE



- |                  |                 |
|------------------|-----------------|
| K101R-160151571  | K205R-160171916 |
| K102L-160151586  | K206L-160171933 |
| K102R-160151600  | K206R-160171941 |
| K103L-160151614  | K209L-160171949 |
| K104L-160151629  | K207R-160175481 |
| K106L-160159937  |                 |
| K208L-160151655  |                 |
| K100R-160158666  |                 |
| K103R-160158679  |                 |
| K105L-160158694  |                 |
| K107L-160158706  |                 |
| K104R-160168861  |                 |
| K108L-160168881  |                 |
| K1001L-160168916 |                 |
| K1001R-160168930 |                 |
| K1002R-160168888 |                 |
| K1003R-160168901 |                 |
| K1004L-160168944 |                 |
| K1004R-160168959 |                 |
| K106R-160168873  |                 |
| K1005L-160169874 |                 |
| K1005R-160168989 |                 |
| K1006R-160169004 |                 |
| K200L-160171828  |                 |
| K200R-160171841  |                 |
| K201L-160171854  |                 |
| K201R-160171868  |                 |
| K202R-160171882  |                 |
| K204L-160171896  |                 |
| K204R-160171906  |                 |

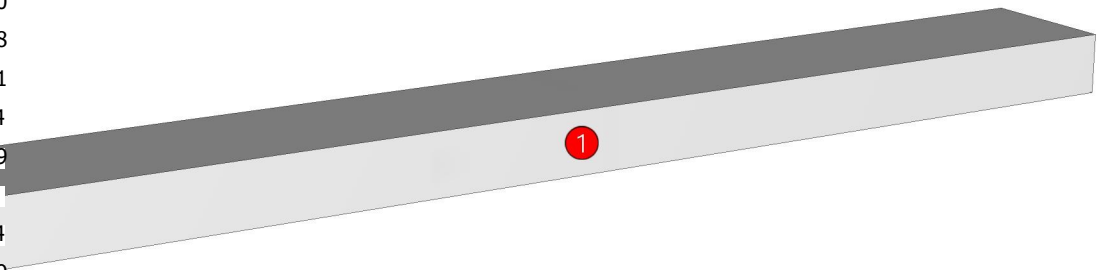

<b>Model</b>	RHYTHM_CN_DUT-500N		
<b>Creator</b>	CHALEAMPHON	<b>.BCP Name</b>	INDEX_C3D_KITCHEN2
<b>Reviewer</b>		<b>Order</b>	H001413
<b>Approves</b>		<b>Date</b>	20/12/2024

No.	Article No.	Description	Mat	Dimension	Cutting Size	Typepology	Skin
0	RHYTHM_CN_DUT-500N			500x25x60			
	RHYTHM_CN_DUT-500N-01	UNDER	PB-ST	25x60x500	25X58X500;L2:W0	182000 _STR=20.07 _EDG=WHITE-1	2

<b>Model</b>	RHYTHM_CN_LED_1167R		
<b>Creator</b>	CHALEAMPON	<b>.BCP Name</b>	INDEX_C3D_KITCHEN2
<b>Reviewer</b>		<b>Order</b>	H001416
<b>Approves</b>		<b>Date</b>	20/12/2024

## RHYTHM\_CN\_LED\_1167R-1167X299X48

### Colour

05.68=ML.BROWN NORDIC#BT1 (MATT WOODGRAIN)  
20.04=ML.SANDSTONE#073\_PEARL

### Edge

01.381=1 ML.BROWN NORDIC BT1  
01.155=1 SANDSTONE (P7-500M1)

<b>R&amp;D REVIEW</b>	
<input checked="" type="checkbox"/>	DWG.Customer
<input checked="" type="checkbox"/>	Work Report
<input type="checkbox"/>	Function
<input type="checkbox"/>	สินค้าตรงตัวอย่าง
ผู้ทบทวน <u>P.SAWAI</u>	
<u>20/12/2024</u>	

K102R-160151600  
K100R-160158666  
K1001R-160168930  
K1002R-160168888  
K200R-160171841  
K201R-160171868  
K202R-160171882

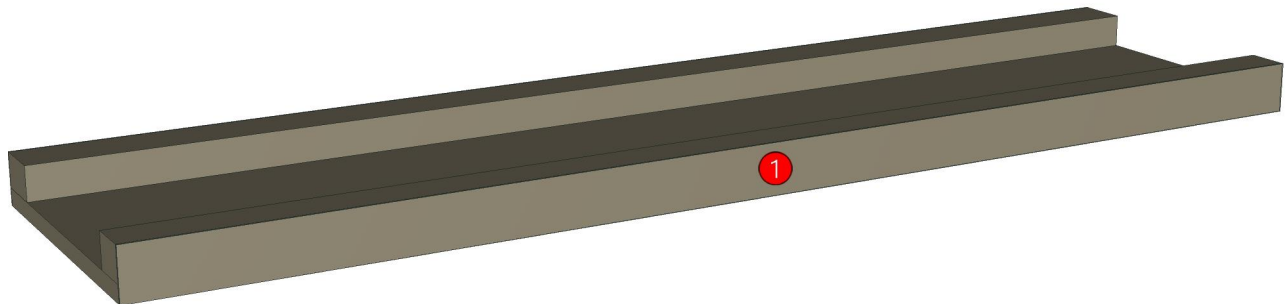

<b>Model</b>	RHYTHM_CN_LED_1167R		
<b>Creator</b>	CHALEAMPHON	<b>.BCP Name</b>	INDEX_C3D_KITCHEN2
<b>Reviewer</b>		<b>Order</b>	H001416
<b>Approves</b>		<b>Date</b>	20/12/2024

No.	Article No.	Description	Mat	Dimension	Cutting Size	Typepology	Skin
0	RHYTHM_CN_LED_1167R			1167x48x299			
	RHYTHM_CN_LED_1167R-01	LED_BOX	PB-	48x299x1167	48X297X1167;L2:W0	182000_STR=20.04_EDG=SANDSTONE073-1	2
	RHYTHM_CN_LED_1167R-01A	FLOOR BOX	PB-ST	16x299x1167	16X299X1167;NO EDGE	182001_STR=20.04_EDG=-	2
	RHYTHM_CN_LED_1167R-01B	FRONT SUPPORT BOX	PB-	32x40x1167	32X40X1167;NO EDGE	182002_STR=20.04_EDG=-	2
	RHYTHM_CN_LED_1167R-01C	BACK SUPPORT BOX	PB-	32x50x1167	32X50X1167;NO EDGE	182003_STR=20.04_EDG=-	2