

Model	ESCENT_UB2_DB20LSGR		
Creator	PASATHORN	.BCP Name	INDEX_C3D_KITCHEN2
Reviewer		Order	I004612
Approves		Date	06/11/2025

ESCENT_UB2_DB20LSGR-200X570X922

Colour

03.41 PVC T.0.13 MM. BEIGE MFI599_ED
05.41 ML FOSS ZILK# BK2 (CROSS METAL)_

-
-
-

Edge

01.319 1 MFI599 PEARL _
01.299 1 FOSS ZILK BK2 A1285 TH00 _

-
-
-



R&D REVIEW	
<input checked="" type="checkbox"/>	DWG.Customer
<input checked="" type="checkbox"/>	Work Report
<input type="checkbox"/>	Function
<input type="checkbox"/>	สินค้าตรงตัวอย่าง
ผู้ทบทวน _____	

K7L-160170744

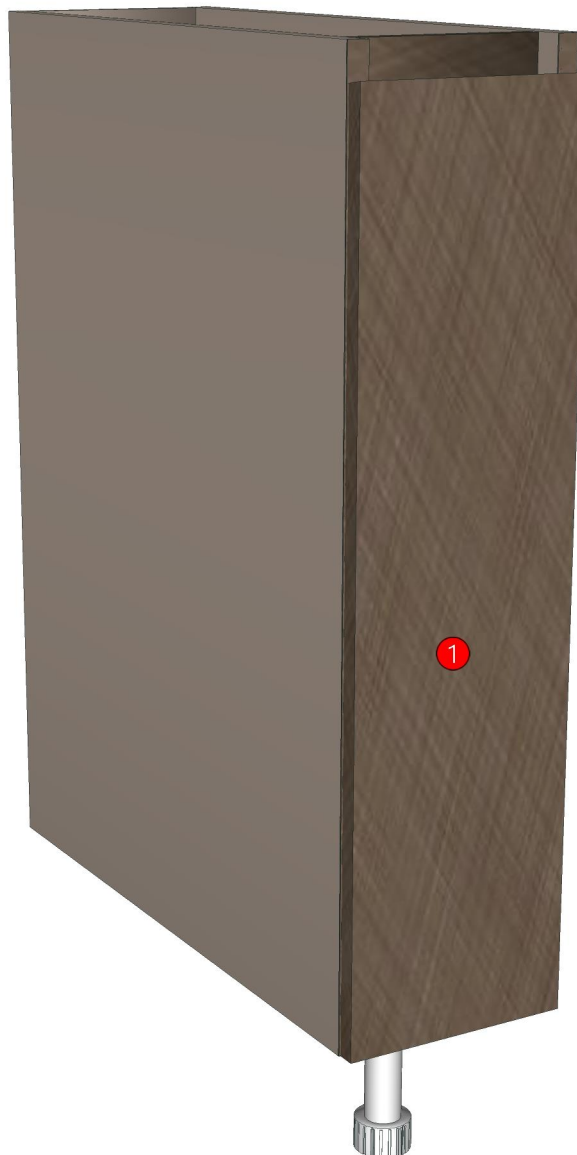

Model	-ESCENT_UB2_DB20LSGR		
Creator		.BCP Name	INDEX_C3D_KITCHEN2
Reviewer		Order	I004612
Approves		Date	



Model	ESCENT_UB2_DBC7550RS		
Creator	PASATHORN	.BCP Name	INDEX_C3D_KITCHEN2
Reviewer		Order	I004618
Approves		Date	07/11/2025

ESCENT_UB2_DBC7550RS-750X570X922

Colour

03.41 PVC T.0.13 MM.?? BEIGE MFI599_
05.41 ML FOSS ZILK# BK2 (CROSS METAL)_
06.01 TEXTURE DEAD STOCK_
-
-

Edge

01.319 1 MFI599 PEARL _
01.299 1 FOSS ZILK BK2 A1285 TH00 _
-
-
-

R&D REVIEW	
<input checked="" type="checkbox"/>	DWG.Customer
<input checked="" type="checkbox"/>	Work Report
<input type="checkbox"/>	Function
<input type="checkbox"/>	สินค้าตรงตัวอย่าง
ผู้ทบทวน _____	

K7L-160170744



Model	-ESCENT_UB2_DBC7550RS		
Creator		.BCP Name	INDEX_C3D_KITCHEN2
Reviewer		Order	I004618
Approves		Date	

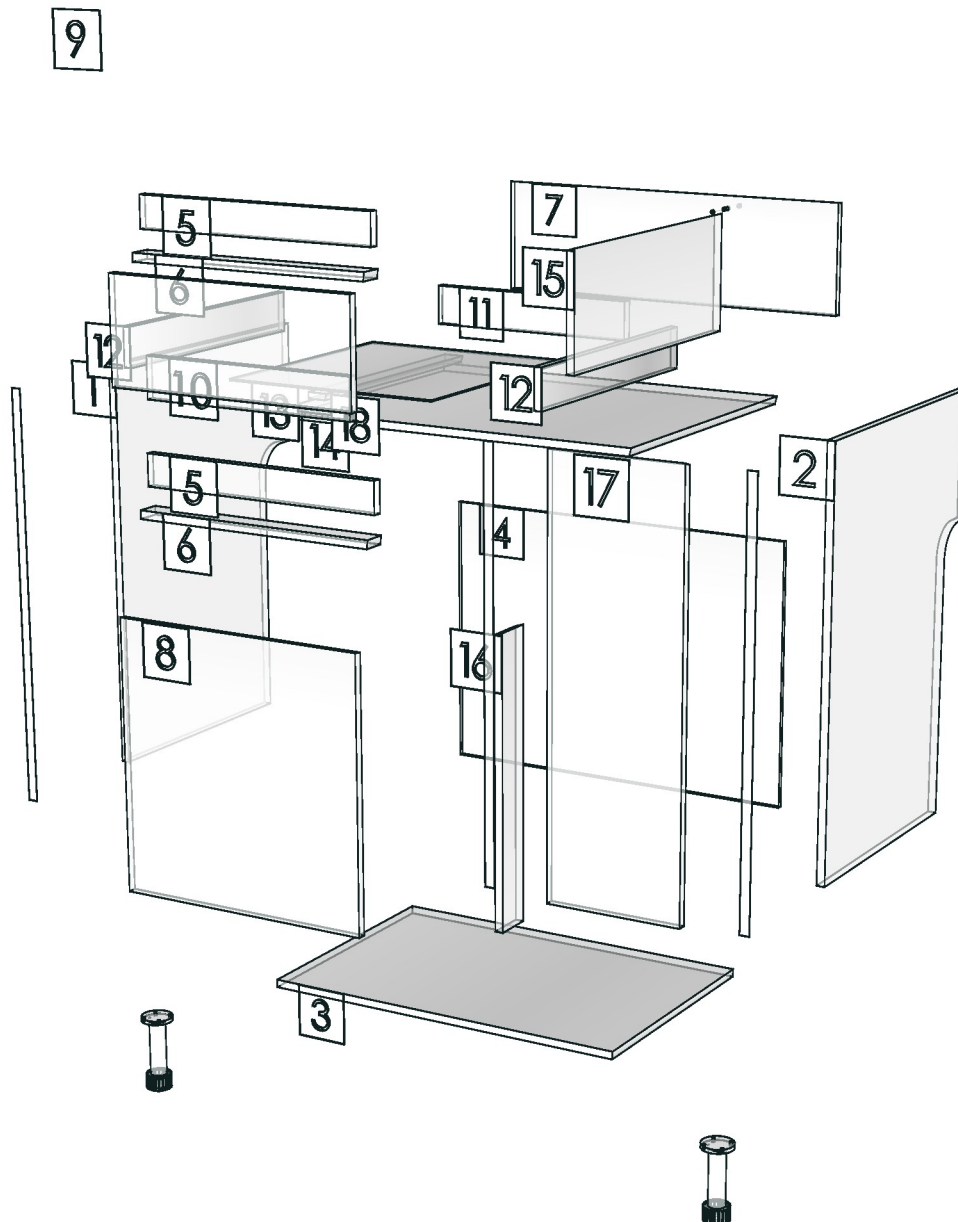

Model	ESCENT_UB2_DBO666R		
Creator	PASATHORN	.BCP Name	INDEX_C3D_KITCHEN2
Reviewer		Order	I004608
Approves		Date	06/11/2025

ESCENT_UB2_DBO666R-666X570X922

Colour

03.41 PVC T.0.13 MM.?? BEIGE MFI599_ED
05.41 ML FOSS ZILK# BK2 (CROSS METAL)_
-
-
-



Edge

01.319 1 MFI599 PEARL _
01.299 1 FOSS ZILK BK2 A1285 TH00 _
-
-
-

R&D REVIEW	
<input checked="" type="checkbox"/>	DWG.Customer
<input checked="" type="checkbox"/>	Work Report
<input type="checkbox"/>	Function
<input type="checkbox"/>	สินค้าตรงตัวอย่าง
ผู้ทบทวน _____	

K7L-160170744

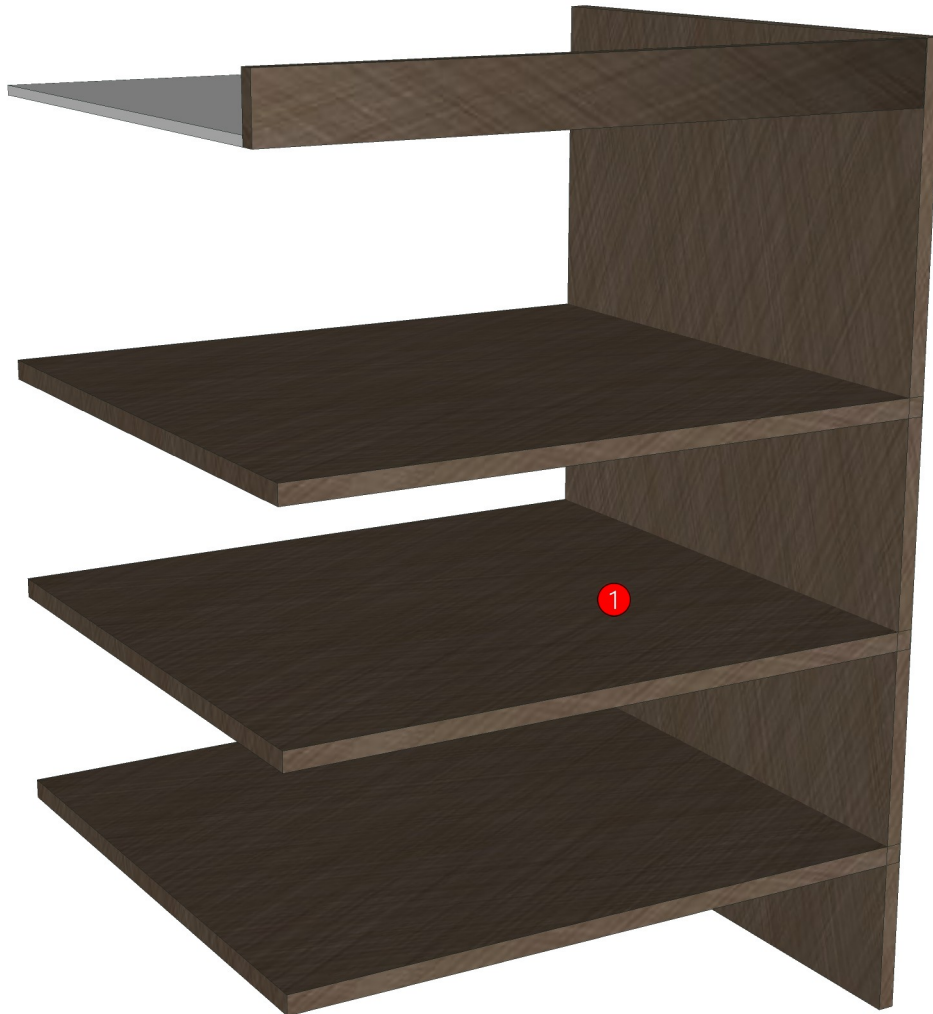

Model	-ESCENT_UB2_DBO666R		
Creator		.BCP Name	INDEX_C3D_KITCHEN2
Reviewer		Order	I004608
Approves		Date	

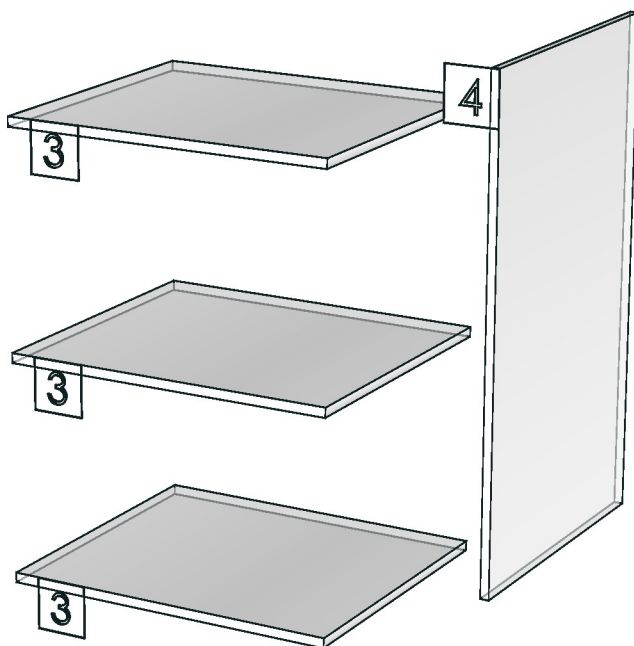
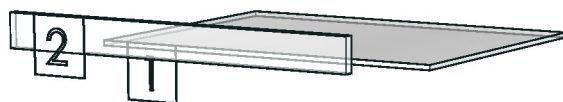

Model	ESCENT_UB2_DBS60L		
Creator	PASATHORN	.BCP Name	INDEX_C3D_KITCHEN2
Reviewer		Order	I004573
Approves		Date	03/11/2025

ESCENT_UB2_DBS60L-600X570X922

Colour

03.41 PVC T.0.13 MM.?? BEIGE MFI599_ED
05.41 ML FOSS ZILK# BK2 (CROSS METAL)_

-
-
-



Edge

01.319 1 MFI599 PEARL _
01.299 1 FOSS ZILK BK2 A1285 TH00 _

-
-
-

R&D REVIEW	
<input checked="" type="checkbox"/>	DWG.Customer
<input checked="" type="checkbox"/>	Work Report
<input type="checkbox"/>	Function
<input type="checkbox"/>	สินค้าตรงตัวอย่าง
ผู้ทบทวน _____	

K7L-160170744



Model	-ESCENT_UB2_DBS60L		
Creator		.BCP Name	INDEX_C3D_KITCHEN2
Reviewer		Order	I004573
Approves		Date	

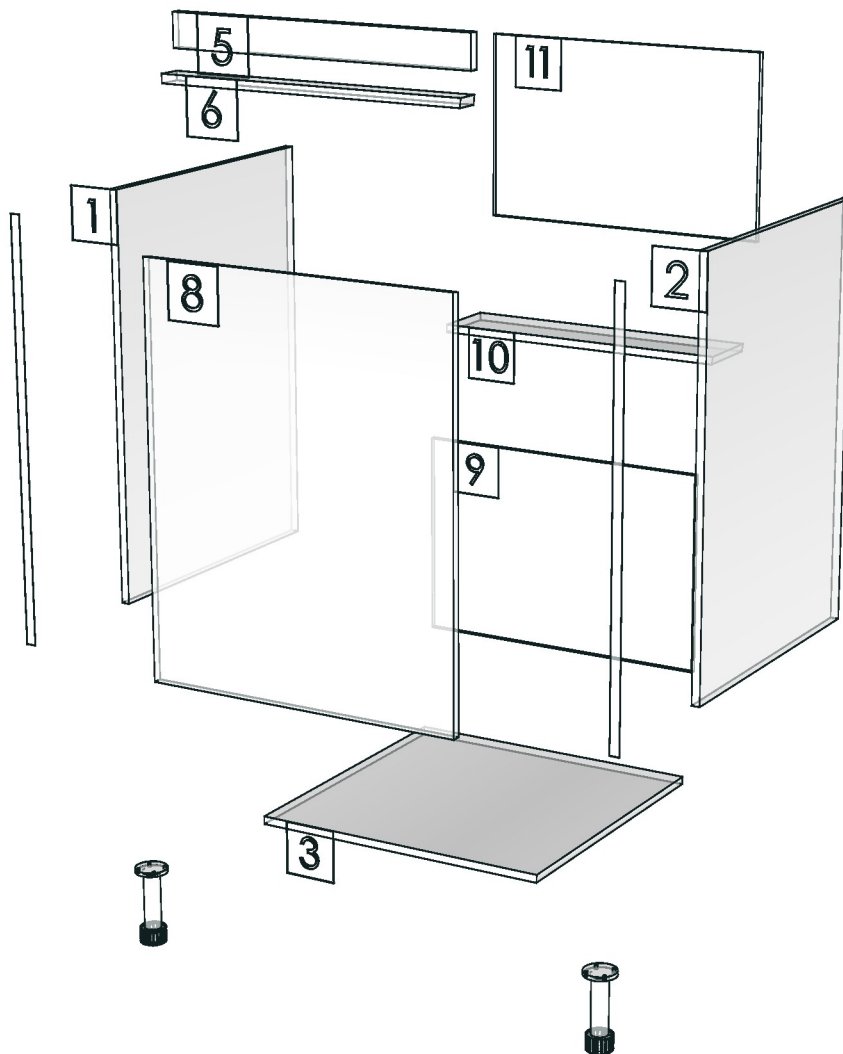

Model	ESCENT_UB2_DEPB		
Creator	PASATHORN	.BCP Name	INDEX_C3D_KITCHEN2
Reviewer		Order	I003204
Approves		Date	02/07/2024

ESCENT_UB2_DEPB-16X590X772

Colour

05.41 ML FOSS ZILK# BK2 (CROSS METAL)_

-

-

-

K1L-160177280_ED



K1R-160170715

K2L-160177289_ED



K2R-160147377

K3L-160147386_ED



K3R-160170724

K4R-160170734

K5L-160177265_ED



K7L-160170744

K8R-160170757

Edge

01.299 1 FOSS ZILK BK2 A1285 TH00 _

-

-

-

-

K9L-160170770

K1100R-160170780



Model	ESCENT_UB2_DEPB		
Creator	PASATHORN	.BCP Name	INDEX_C3D_KITCHEN2
Reviewer		Order	I003204
Approves		Date	02/07/2024

No.	Article No.	Description	Mat	Dimension	Cutting Size	Typepology	Skin
0	ESCENT_UB2_DEPB ESCENT_UB2_DEPB-01	ESCENT_UB2_DEPB DEP-SP	PB-	16x772x590 16x590x772	16X588X770;L2:W2	181000_STR=05.41_EDG=A1285TH00-1	2

Model	ESCENT_UB2_DFB		
Creator	PASATHORN	.BCP Name	INDEX_C3D_KITCHEN2
Reviewer		Order	I003201
Approves		Date	02/07/2024





ESCENT_UB2_DFB-150X16X772

Colour

03.41 PVC T.0.13 MM.?? BEIGE MFI599_ED
05.41 ML FOSS ZILK# BK2 (CROSS METAL)_

Edge

01.319 1 MFI599 PEARL _
01.299 1 FOSS ZILK BK2 A1285 TH00 _

- -
 - K1L-160177280_ED 
 - K1R-160170715
 - K2L-160177289_ED 
 - K2R-160147377
 - K3L-160147386_ED 
 - K3R-160170724
 - K4R-160170734
 - K5L-160177265_ED 
 - K7L-160170744
 - K8R-160170757
- K9L-160170770
K1100R-160170780

R&D REVIEW

- DWG.Customer
- Work Report
- Function
- สินค้าตรงตัวอย่าง

ผู้ทบทวน 



Model	-ESCENT_UB2_DFB		
Creator		.BCP Name	INDEX_C3D_KITCHEN2
Reviewer		Order	I003201
Approves		Date	

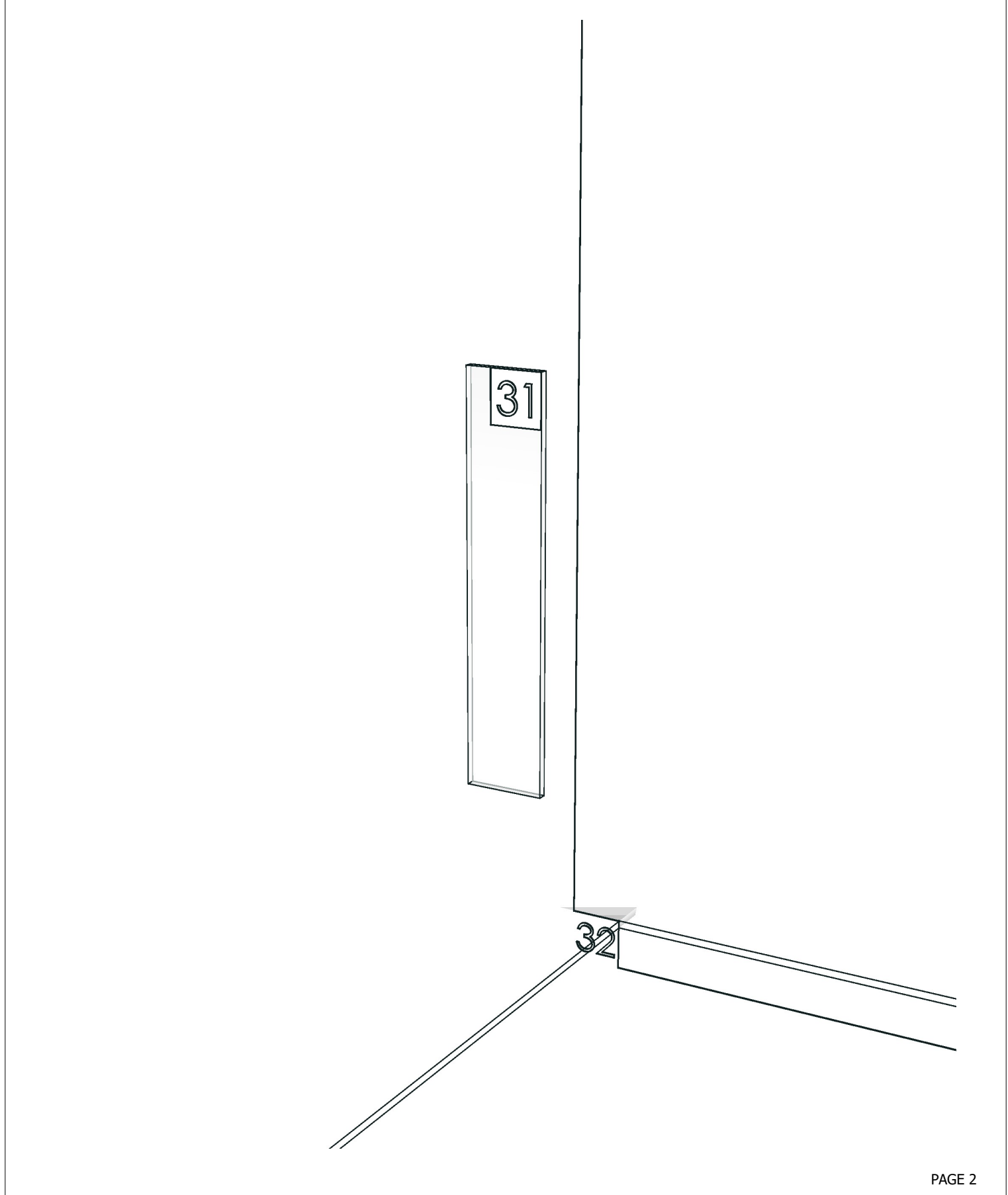

Model	ESCENT_UB2_DFLMV		
Creator	PASATHORN	.BCP Name	INDEX_C3D_KITCHEN2
Reviewer		Order	I003203
Approves		Date	02/07/2024

ESCENT_UB2_DFLMV-150X16X800

Colour

03.41 PVC T.0.13 MM.?? BEIGE MFI599_

-

-

-

K1L-160177280_ED



K1R-160170715

K2L-160177289_ED



K2R-160147377

Edge

01.319 1 MFI599 PEARL _

-

-

-

-

K1100R-160170780

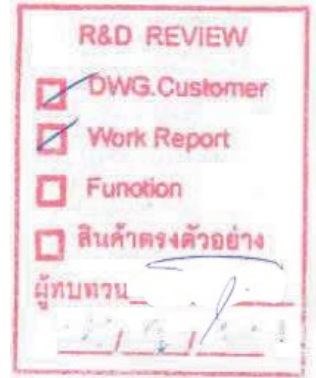

K7L-160170744

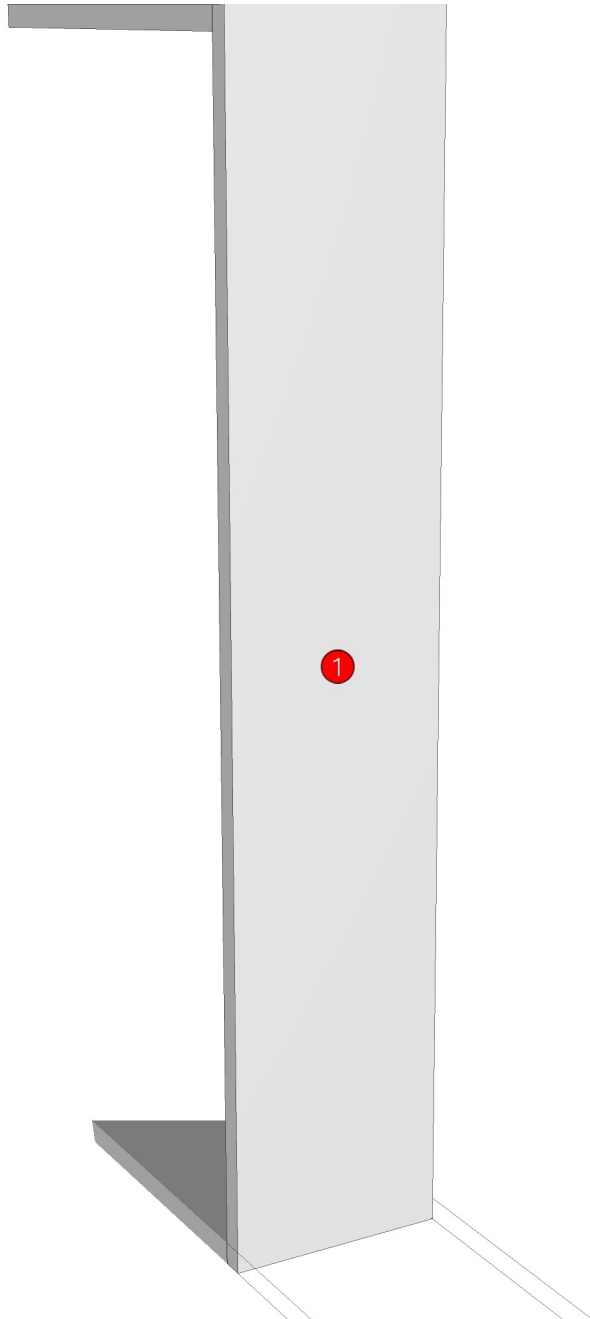

Model	-ESCENT_UB2_DFLMV		
Creator		.BCP Name	INDEX_C3D_KITCHEN2
Reviewer		Order	I003203
Approves		Date	

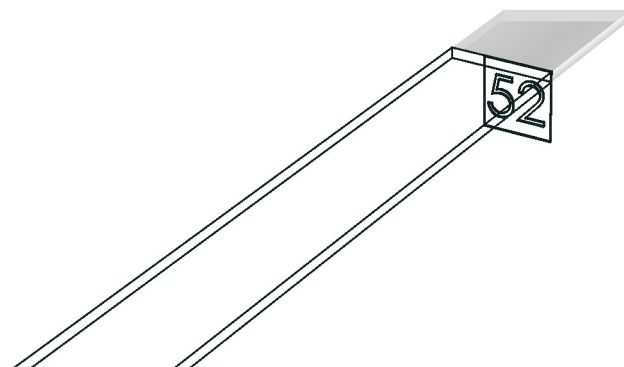
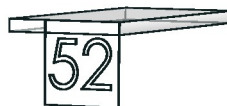

Model	ESCENT_UB2_DFLS		
Creator	PASATHORN	.BCP Name	INDEX_C3D_KITCHEN2
Reviewer		Order	I004594
Approves		Date	04/11/2025

ESCENT_UB2_DFLS-400X400X640

Colour

03.41 PVC T.0.13 MM. BEIGE MFI599_ED

-
-
-
-

Edge

01.319 1 MFI599 PEARL _

-
-
-
-



R&D REVIEW	
<input checked="" type="checkbox"/>	DWG.Customer
<input checked="" type="checkbox"/>	Work Report
<input type="checkbox"/>	Function
<input type="checkbox"/>	สินค้าตรงตัวอย่าง
ผู้ทบทวน _____	

K7L-160170744

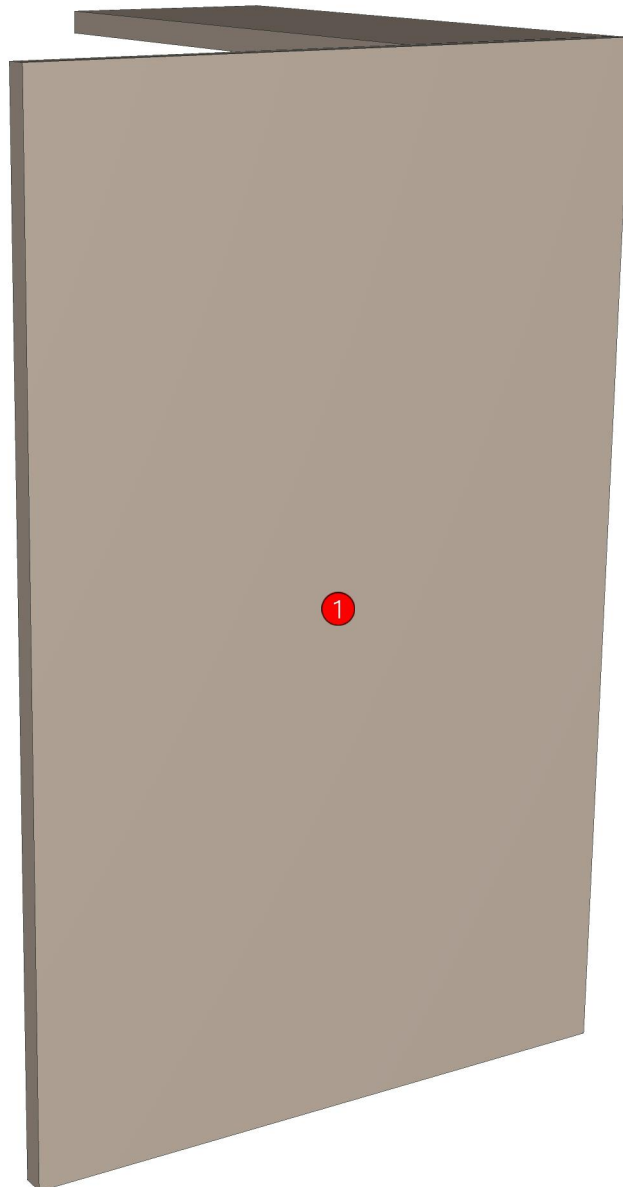

Model	-ESCENT_UB2_DFLS		
Creator		.BCP Name	INDEX_C3D_KITCHEN2
Reviewer		Order	I004594
Approves		Date	

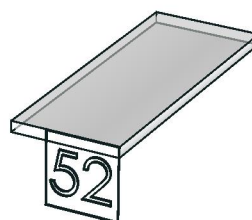
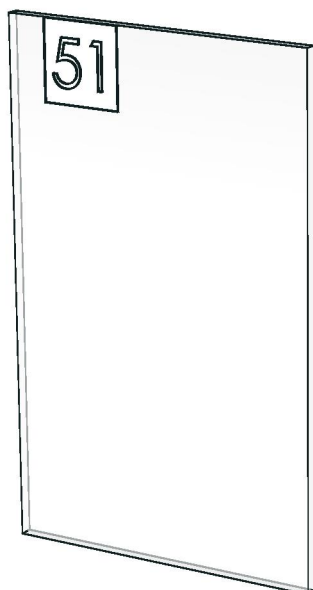

Model	ESCENT_UB2_DF_CL1450		
Creator	PASATHORN	.BCP Name	INDEX_C3D_KITCHEN2
Reviewer		Order	I004617
Approves	P.SAWAI	Date	07/11/2025

ESCENT_UB2_DF_CL1450-1450X9X370

Colour

03.41 PVC T.0.13 MM. BEIGE MFI599_ED

-
-
-
-

Edge

01.319 1 MFI599 PEARL _

-
-
-
-



R&D REVIEW

- DWG.Customer
- Work Report
- Function
- สินค้าตรงตัวอย่าง

ผู้ทบทวน P.SAWAI
25/8/2563

K7L-160170744

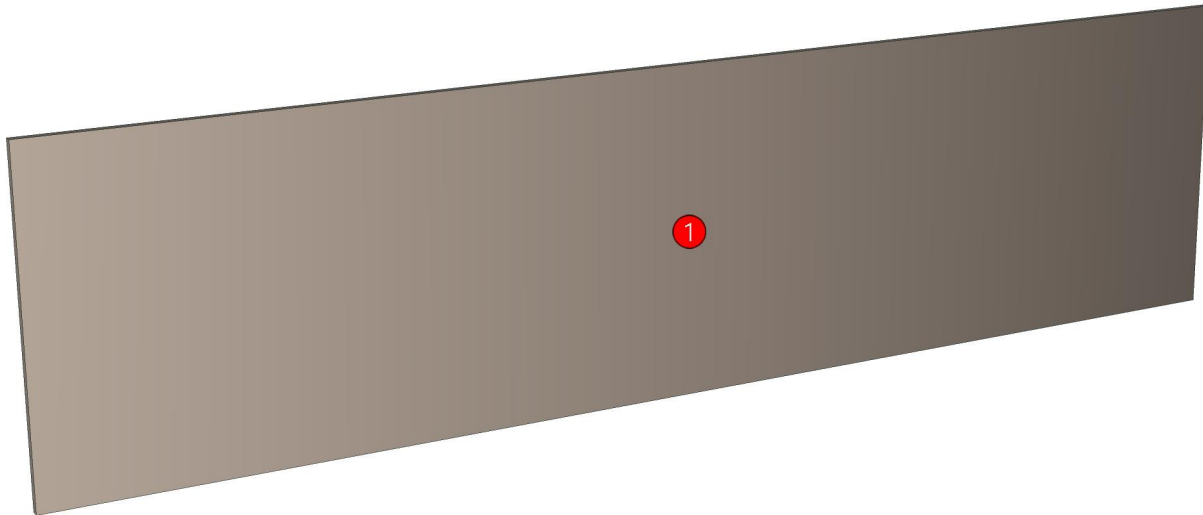

Model	ESCENT_UB2_DF_CL1450		
Creator	PASATHORN	.BCP Name	INDEX_C3D_KITCHEN2
Reviewer		Order	I004617
Approves	P. SAWAI	Date	07/11/2025

No.	Article No.	Description	Mat	Dimension	Cutting Size	Typepology	Skin
0	ESCENT_UB2_DF_	ESCENT_UB2_DF_CL1450		1450x370x9			
	ESCENT_UB2_DF_CL1450-01	DFCL_ED-SP	PB-SP	9x370x1450	9X369X1449;L1:W1	183000_STR=03.41_EDG=MFI599 PEARL-1	2



Model	ESCENT_UB2_DF_CL300		
Creator	PASATHORN	.BCP Name	INDEX_C3D_KITCHEN2
Reviewer		Order	I004584
Approves		Date	04/11/2025

ESCENT_UB2_DF_CL300-300X9X370

Colour

03.41 PVC T.0.13 MM.?? BEIGE MFI599_

-

-

K1L-160177280_ED



K1R-160170715

Edge

01.319 1 MFI599 PEARL _

-

-

-

-

K9L-160170770

K1100R-160170780





K4R-160170734

K5L-160177265_ED

K7L-160170744

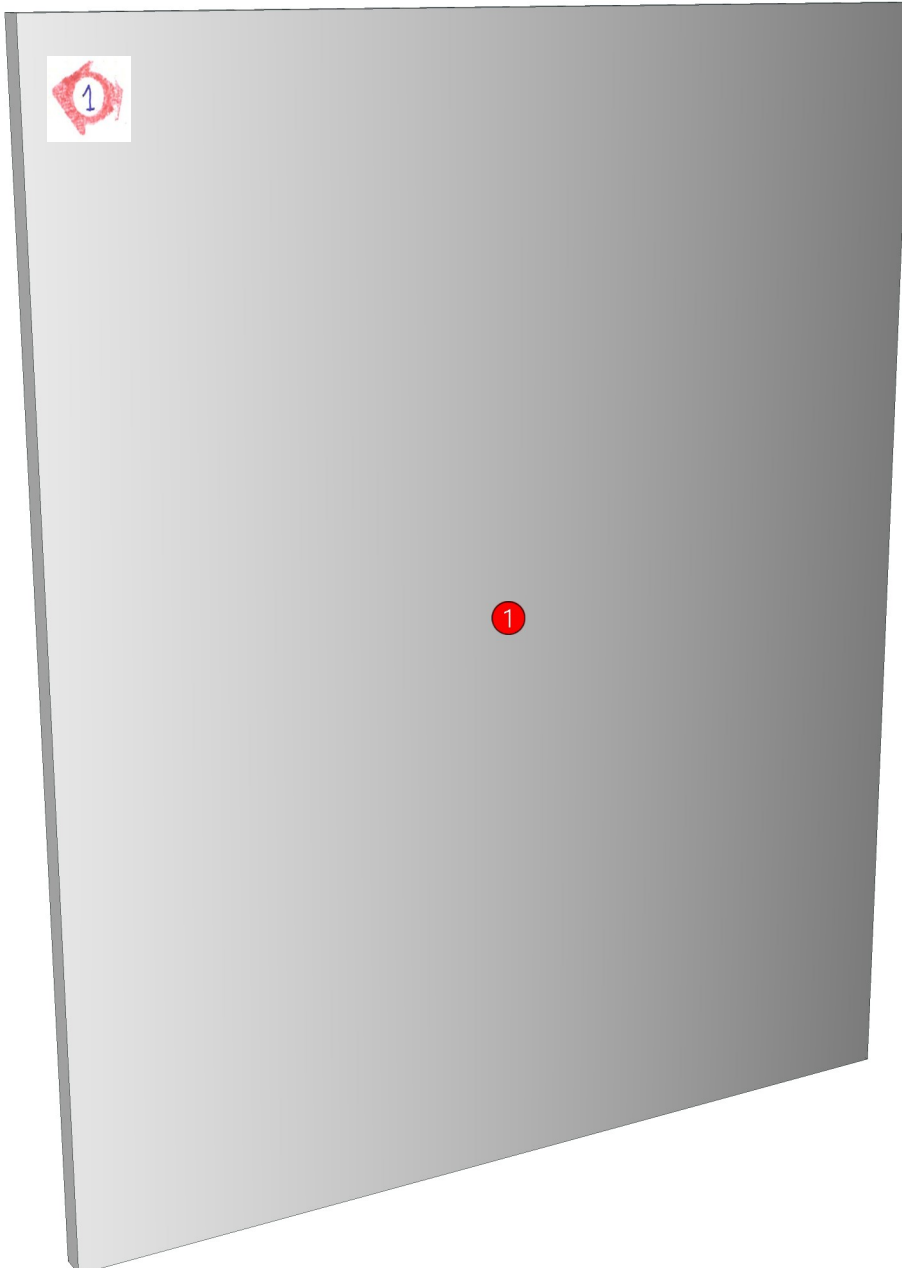
K8R-160170757



Model	ESCENT_UB2_DF_CL300		
Creator	PASATHORN	.BCP Name	INDEX_C3D_KITCHEN2
Reviewer		Order	I004584
Approves		Date	04/11/2025

No.	Article No.	Description	Mat	Dimension	Cutting Size	Typepology	Skin
0	ESCENT_UB2_DF_	ESCENT_UB2_DF_CL300		300x370x9			
	ESCENT_UB2_DF_CL300-01	DFCL_ED-SP	 PB-ST	9x370x300	9X369X299;L1:W1	183000_STR=03.41_EDG=MFI599 PEARL-1	2

Model	ESCENT_UB2_DF_CL400		
Creator	PASATHORN	.BCP Name	INDEX_C3D_KITCHEN2
Reviewer		Order	I004585
Approves	P.SAWAI	Date	04/11/2025

ESCENT_UB2_DF_CL400-400X9X370

Colour

03.41 PVC T.0.13 MM. BEIGE MFI599_ED

-
-
-
-



Edge

01.319 1 MFI599 PEARL _

-
-
-
-

R&D REVIEW

- DWG.Customer
- Work Report
- Function
- สินค้าตรงตัวอย่าง

ผู้ทบทวน P.SAWAI
25/8/2563

K7L-160170744

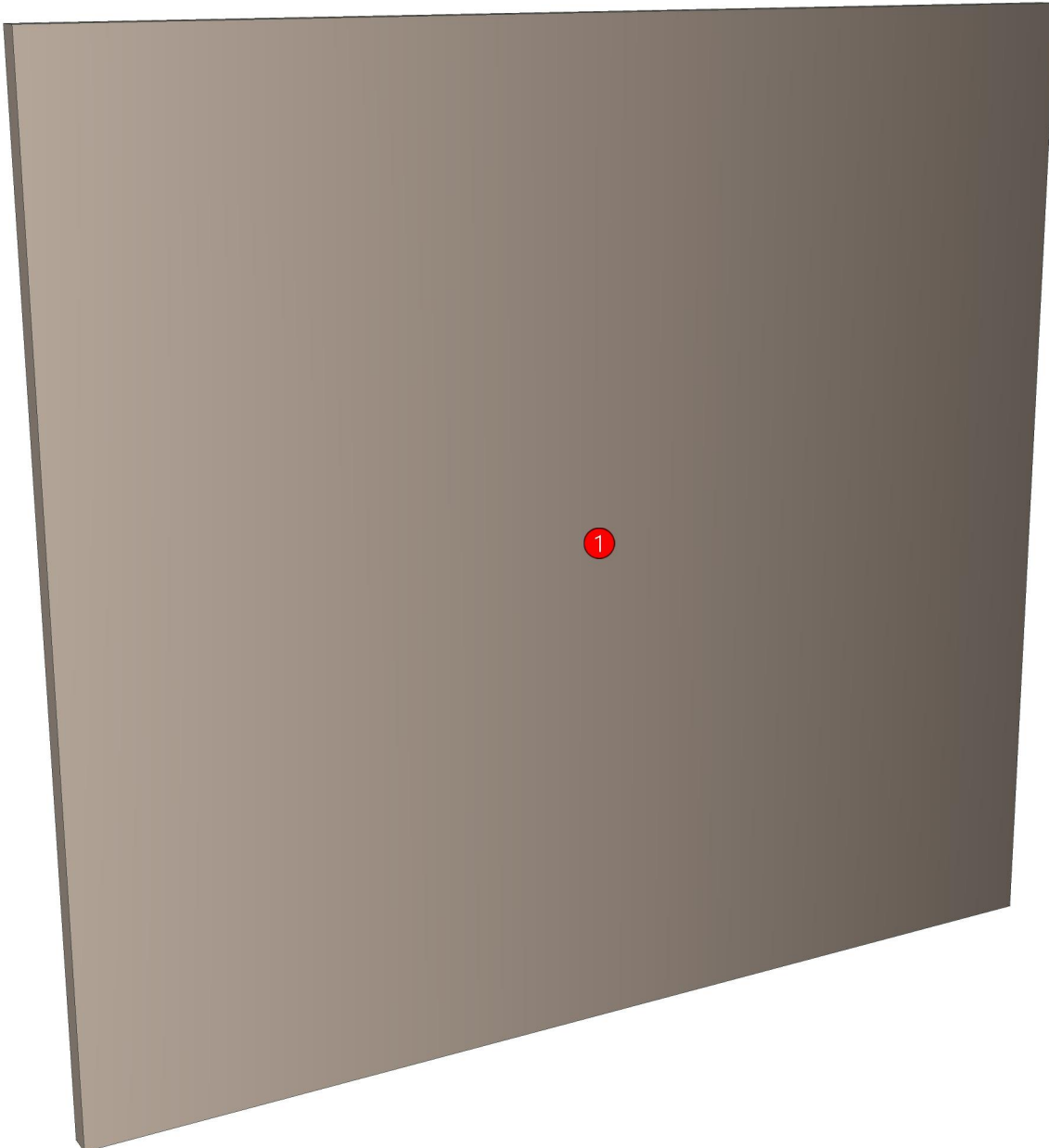

Model	ESCENT_UB2_DF_CL400		
Creator	PASATHORN	.BCP Name	INDEX_C3D_KITCHEN2
Reviewer		Order	I004585
Approves	P. SAWAI	Date	04/11/2025

No.	Article No.	Description	Mat	Dimension	Cutting Size	Typepology	Skin
0	ESCENT_UB2_DF_	ESCENT_UB2_DF_CL400		400x370x9			
	ESCENT_UB2_DF_CL400-01	DFCL_ED-SP	PB-SP	9x370x400	9X369X399;L1:W1	183000_STR=03.41_EDG=MFI599 PEARL-1	2



Model	ESCENT_UB2_DF_CL950		
Creator	PASATHORN	.BCP Name	INDEX_C3D_KITCHEN2
Reviewer		Order	I004587
Approves	P.SAWAI	Date	04/11/2025

ESCENT_UB2_DF_CL950-950X9X370

Colour

03.41 PVC T.0.13 MM. BEIGE MFI599_ED

-
-
-
-



Edge

01.319 1 MFI599 PEARL _

-
-
-
-

R&D REVIEW

- DWG.Customer
- Work Report
- Function
- สินค้าตรงตัวอย่าง

ผู้ทบทวน P.SAWAI
25/8/2563

K7L-160170744

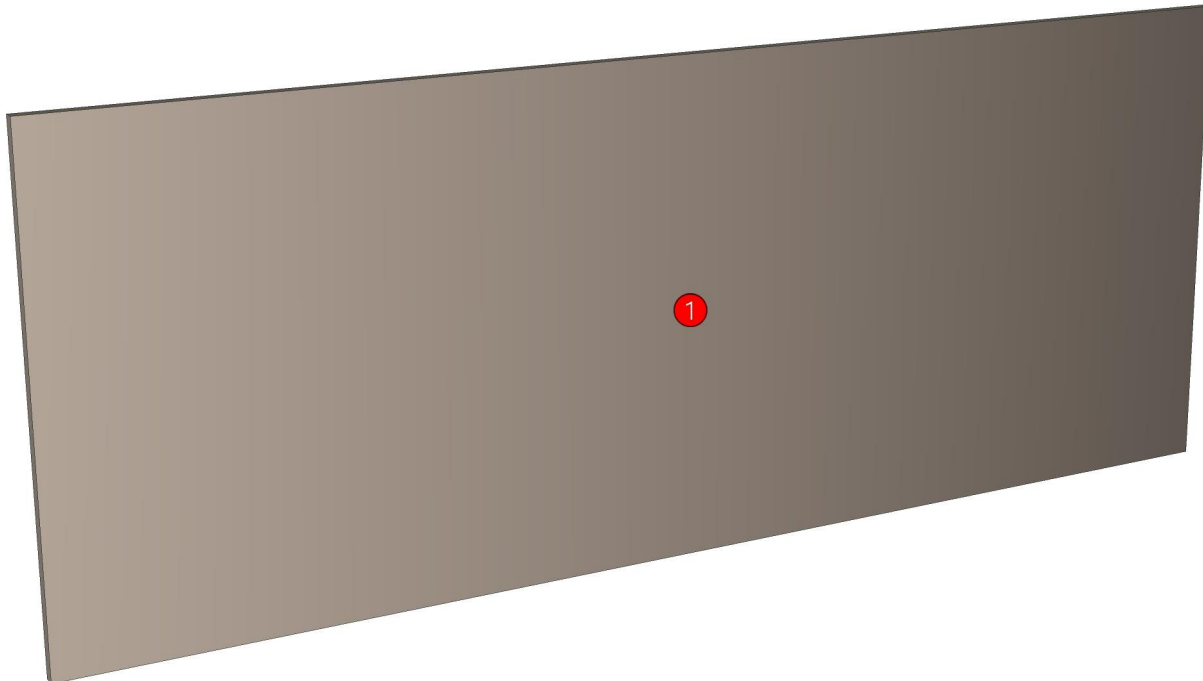

Model	ESCENT_UB2_DF_CL950		
Creator	PASATHORN	.BCP Name	INDEX_C3D_KITCHEN2
Reviewer		Order	I004587
Approves	P. SAWAI	Date	04/11/2025

No.	Article No.	Description	Mat	Dimension	Cutting Size	Typepology	Skin
0	ESCENT_UB2_DF_CL950-01	ESCENT_UB2_DF_CL950 DFCL_ED-SP	PB-SP	950x370x9 9x370x950	9X369X949;L1:W1	183000_STR=03.41_EDG=MFI599 PEARL-1	2



Model	ESCENT_UB2_DL20LS		
Creator	PASATHORN	.BCP Name	INDEX_C3D_KITCHEN2
Reviewer		Order	I004967
Approves		Date	07/04/2026

ESCENT_UB2_DL20LS-200X400X640

Colour

03.41 PVC T.0.13 MM.?? BEIGE MFI599_

-
-
-
-

Edge

01.319 1 MFI599 PEARL _

-
-
-
-

R&D REVIEW	
<input checked="" type="checkbox"/>	DWG.Customer
<input checked="" type="checkbox"/>	Work Report
<input type="checkbox"/>	Function
<input type="checkbox"/>	สินค้าตรงตัวอย่าง
ผู้ทบทวน _____	

K7L-160170744

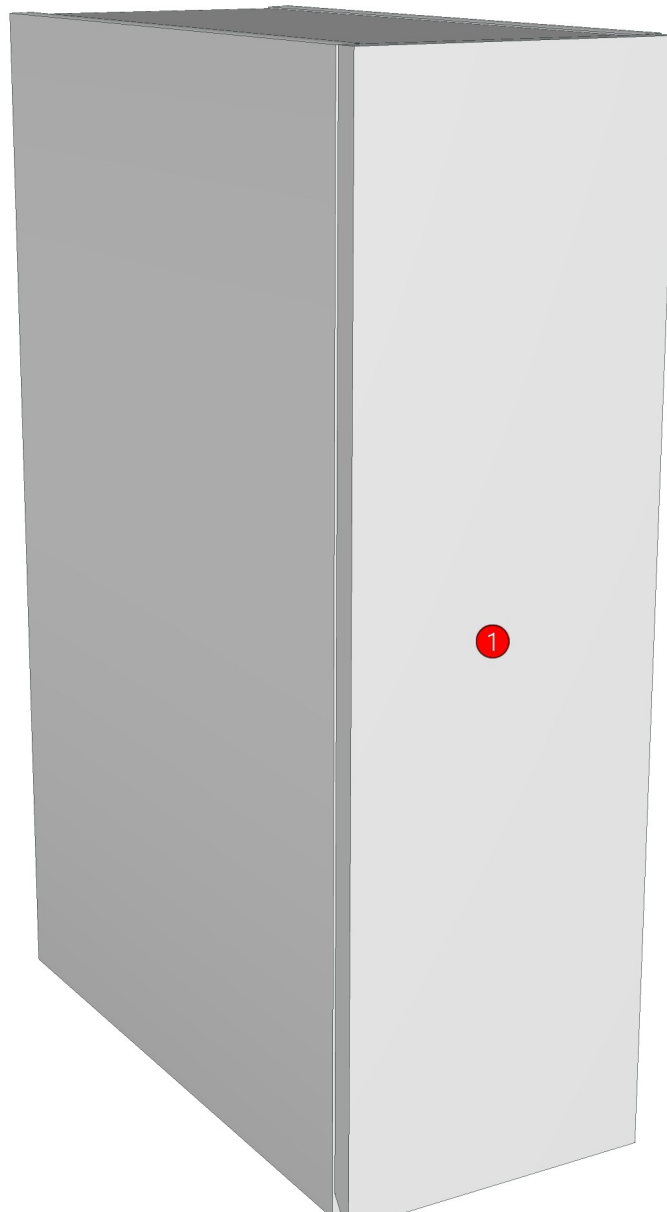

Model	-ESCENT_UB2_DL20LS		
Creator		.BCP Name	INDEX_C3D_KITCHEN2
Reviewer		Order	I004967
Approves		Date	

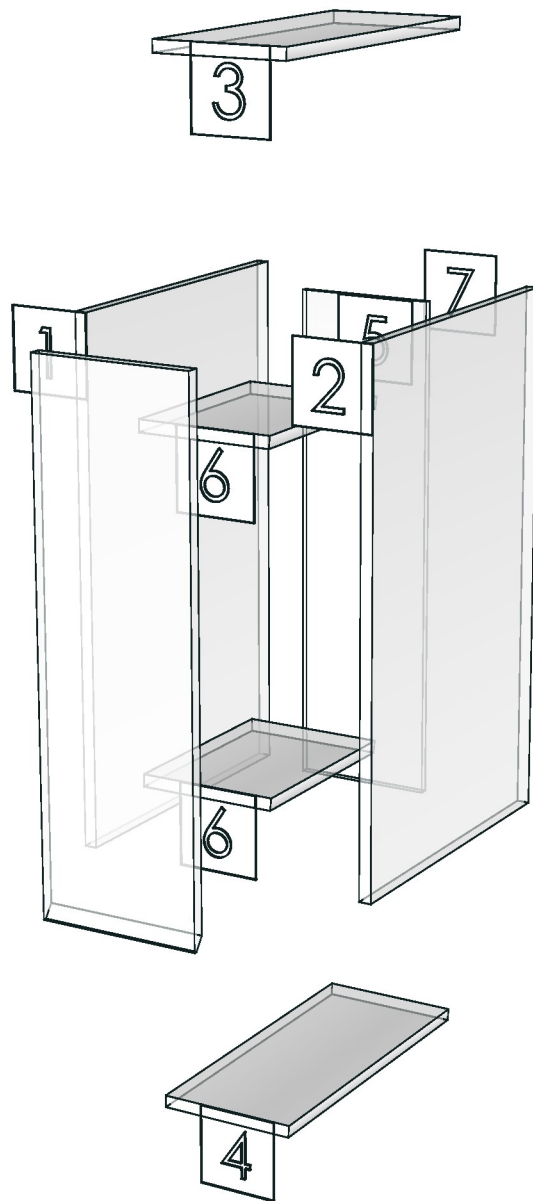

Model	ESCENT_UB2_DL60HRS		
Creator	PASATHORN	.BCP Name	INDEX_C3D_KITCHEN2
Reviewer		Order	I004611
Approves	P.SAWAI	Date	06/11/2025

ESCENT_UB2_DL60HRS-600X400X600

Colour

03.41 PVC T.0.13 MM. BEIGE MFI599_ED

-
-
-
-

Edge

01.319 1 MFI599 PEARL _

-
-
-
-



R&D REVIEW	
<input checked="" type="checkbox"/>	DWG.Customer
<input checked="" type="checkbox"/>	Work Report
<input type="checkbox"/>	Function
<input type="checkbox"/>	สินค้าตรงตัวอย่าง
ผู้ทบทวน <u>P.SAWAI</u>	
<u>06/11/2025</u>	

K7L-160170744

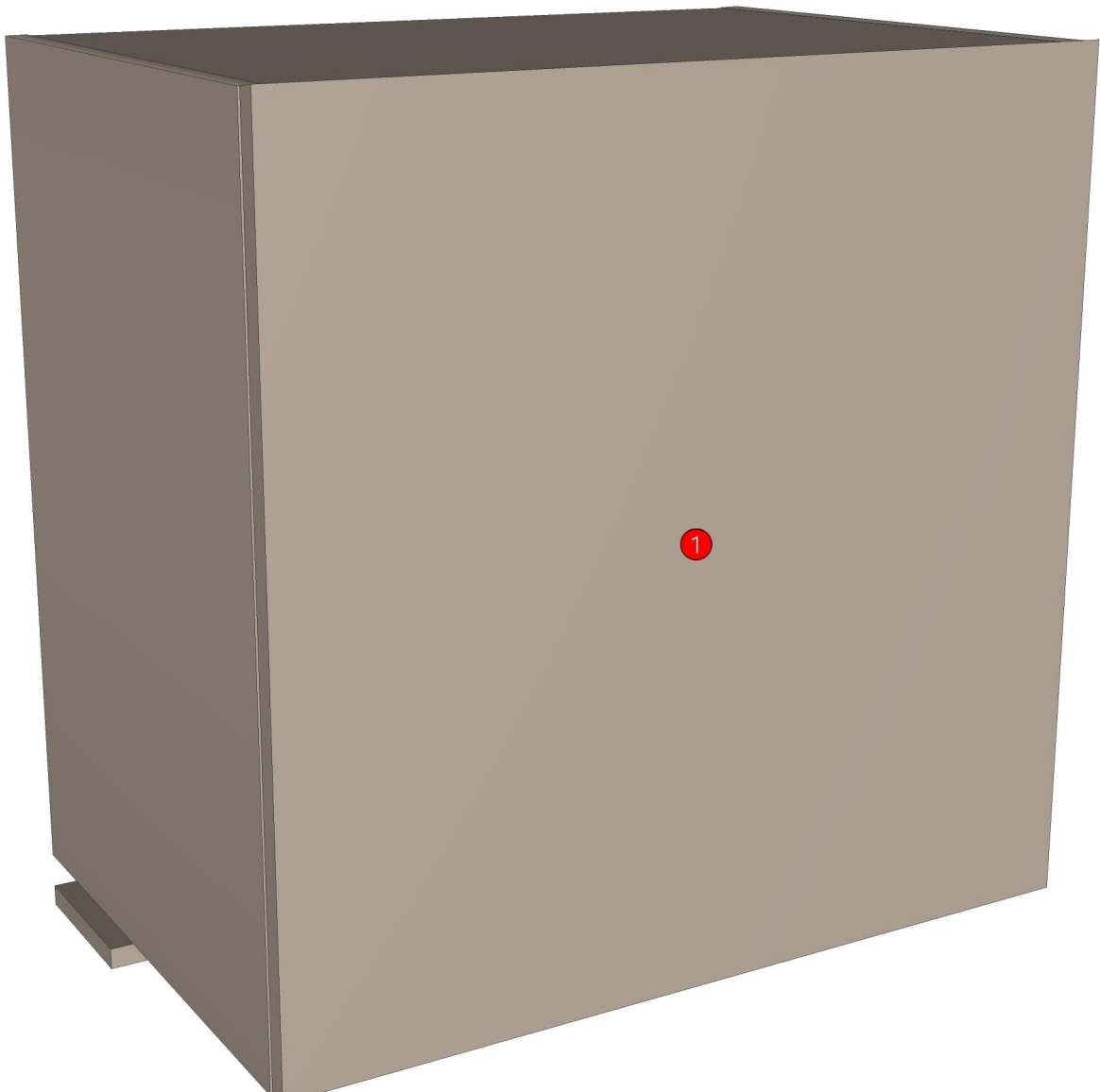

Model	-ESCENT_UB2_DL60HRS		
Creator		.BCP Name	INDEX_C3D_KITCHEN2
Reviewer		Order	I004611
Approves	P. SAWAI	Date	

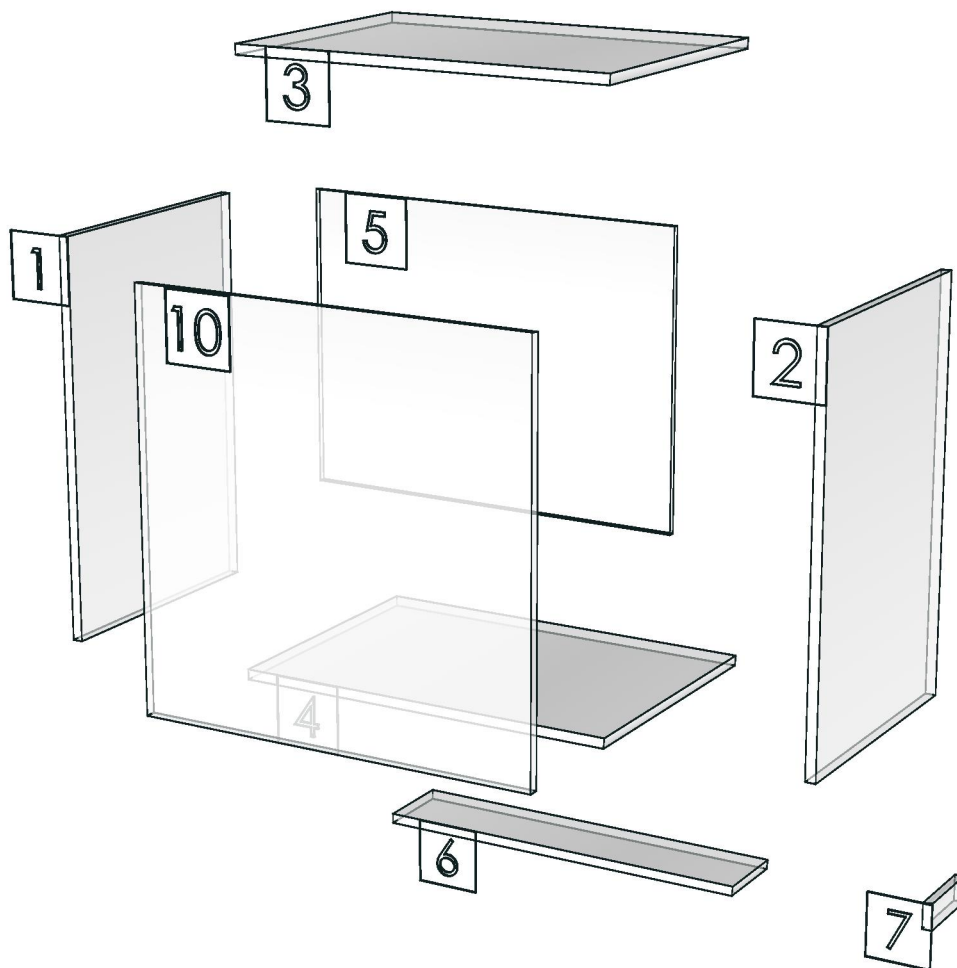

Model	ESCENT_UB2_DLMV60R		
Creator	PASATHORN	.BCP Name	INDEX_C3D_KITCHEN2
Reviewer		Order	I003209
Approves	P.SAWAI	Date	03/07/2024

ESCENT_UB2_DLMV60R-600X350X800

Colour

03.41 PVC T.0.13 MM. BEIGE MFI599_ED

-

-

-

-

K2R-160147377

K7L-160170744

Edge

01.319 1 MFI599 PEARL _

-

-

-

-



R&D REVIEW	
<input checked="" type="checkbox"/>	DWG.Customer
<input checked="" type="checkbox"/>	Work Report
<input type="checkbox"/>	Function
<input type="checkbox"/>	สินค้าตรงตัวอย่าง
ผู้ทบทวน <u>P.SAWAI</u>	
<u>25/8/2563</u>	

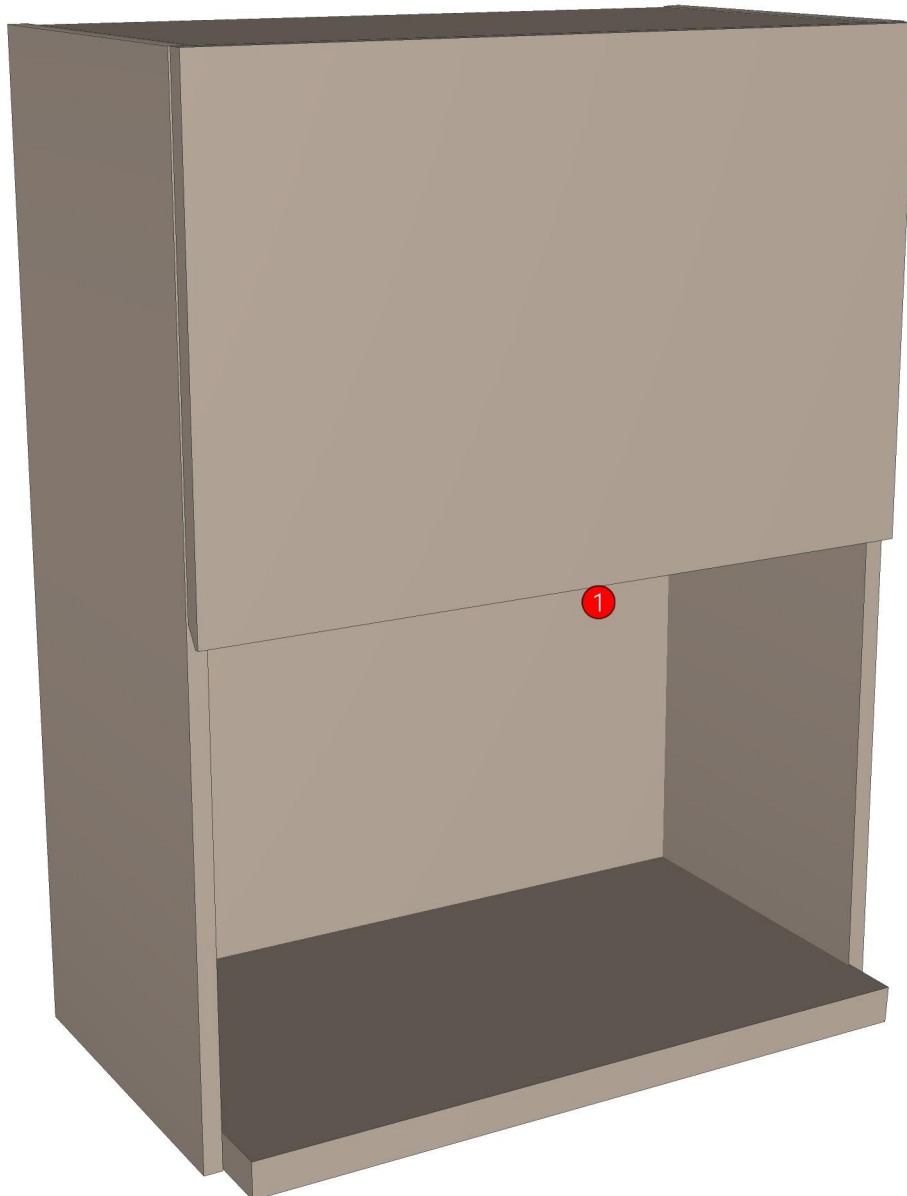

Model	-ESCENT_UB2_DLMV60R		
Creator		.BCP Name	INDEX_C3D_KITCHEN2
Reviewer		Order	I003209
Approves	P.SAWAI	Date	

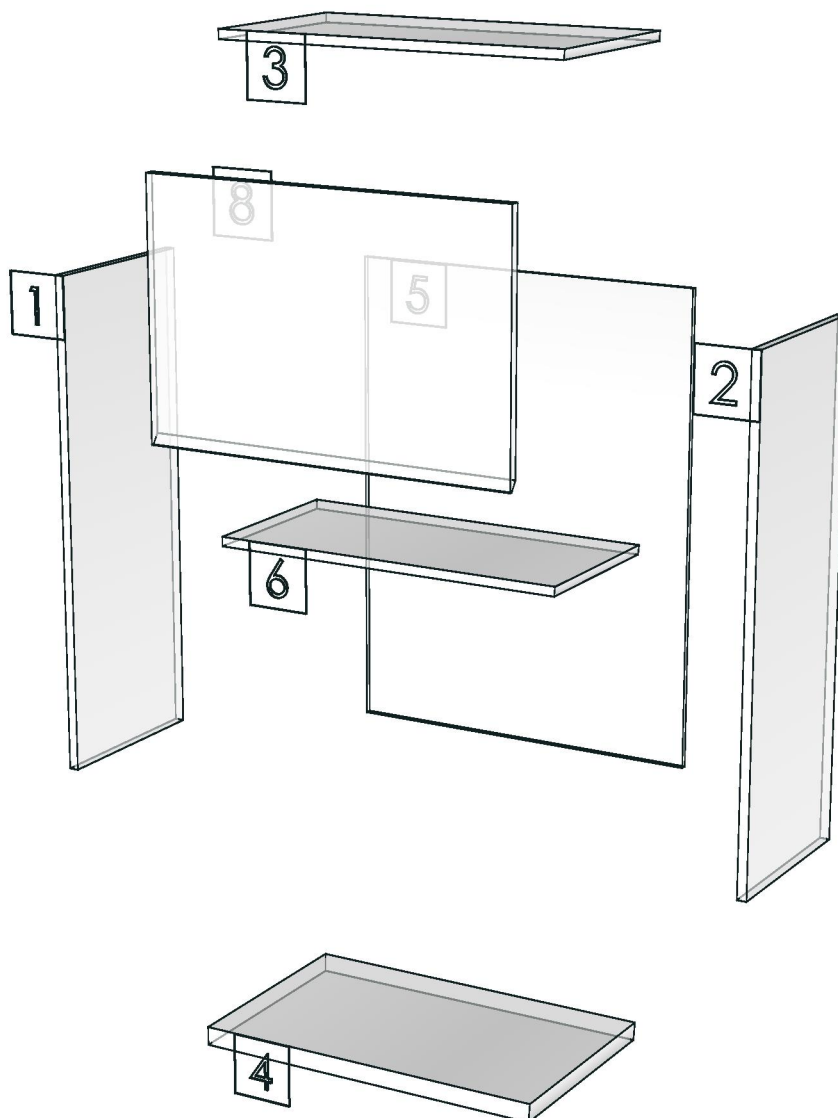

Model	ESCENT_UB2_DUT1450		
Creator	PASATHORN	.BCP Name	INDEX_C3D_KITCHEN2
Reviewer		Order	I004580
Approves		Date	03/11/2025

ESCENT_UB2_DUT1450-1450X60X9

Colour

05.01 ML WHITE VM1012 18/18_

-
-
-
-

Edge

01.47 1 WHITE _

-
-
-
-

R&D REVIEW

- DWG.Customer
- Work Report
- Function
- สินค้าตรงตัวอย่าง

ผู้ทบทวน _____

K7L-160170744

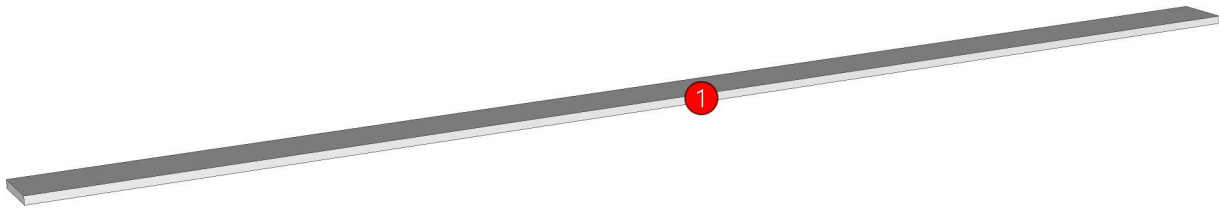

Model	ESCENT_UB2_DUT1450		
Creator	PASATHORN	.BCP Name	INDEX_C3D_KITCHEN2
Reviewer		Order	I004580
Approves		Date	03/11/2025

No.	Article No.	Description	Mat	Dimension	Cutting Size	Typepology	Skin
0	ESCENT_UB2_DUT1450	ESCENT_UB2_DUT1450		1450x9x60			
	ESCENT_UB2_DUT1450-01	DUT-SP	PB-SP	9x60x1450	9X58X1450;L2:W0	182000 _STR=05.01 _EDG=WHITE-1	2

Model	ESCENT_UB2_DUT500		
Creator	PASATHORN	.BCP Name	INDEX_C3D_KITCHEN2
Reviewer		Order	I003197
Approves		Date	02/07/2024

ESCENT_UB2_DUT500-500X60X9

Colour

05.01 ML WHITE VM1012 18/18_

-

-

-

K1L-160177280_ED



K1R-160170715

K2L-160177289_ED



K2R-160147377

K3L-160147386_ED



K3R-160170724

K4R-160170734

K5L-160177265_ED



K7L-160170744

K8R-160170757

Edge

01.47 1 WHITE _

-

-

-

-

K9L-160170770

K1100R-160170780

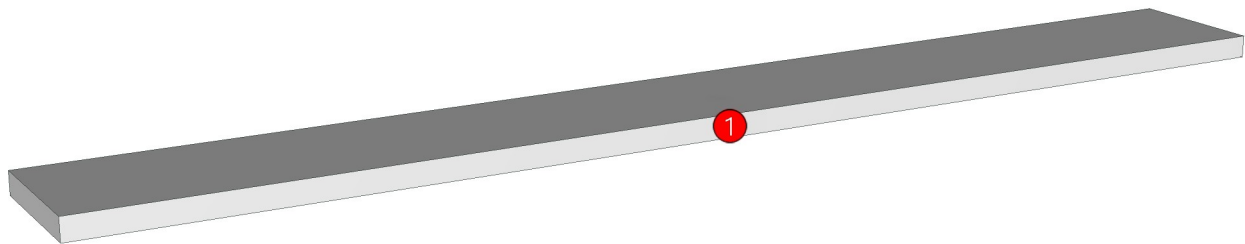
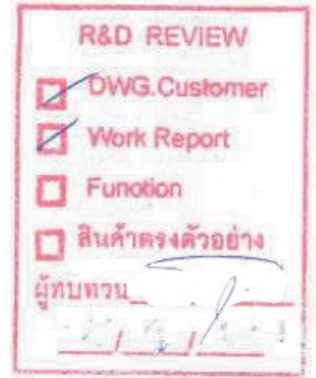

Model	ESCENT_UB2_DUT500		
Creator	PASATHORN	.BCP Name	INDEX_C3D_KITCHEN2
Reviewer		Order	I003197
Approves		Date	02/07/2024

No.	Article No.	Description	Mat	Dimension	Cutting Size	Typepology	Skin
0	ESCENT_UB2_DUT500 ESCENT_UB2_DUT500-01	ESCENT_UB2_DUT500 DUT-SP	PB-ST	500x9x60 9x60x500	9X58X500;L2:W0	182000 _STR=05.01 _EDG=WHITE-1	2

Model	ESCENT_UB2_DUT950		
Creator	PASATHORN	.BCP Name	INDEX_C3D_KITCHEN2
Reviewer		Order	I004578
Approves		Date	03/11/2025

ESCENT_UB2_DUT950-950X60X9

Colour

05.01 ML WHITE VM1012 18/18_

-
-
-
-

Edge

01.47 1 WHITE _

-
-
-
-

R&D REVIEW	
<input checked="" type="checkbox"/>	DWG.Customer
<input checked="" type="checkbox"/>	Work Report
<input type="checkbox"/>	Function
<input type="checkbox"/>	สินค้าตรงตัวอย่าง
ผู้ทบทวน _____	

K7L-160170744

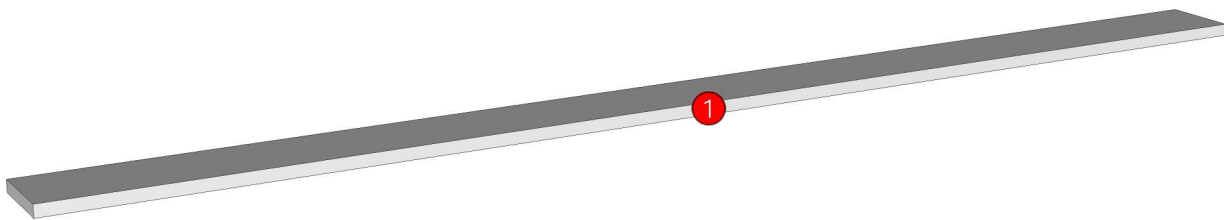

Model	ESCENT_UB2_DUT950		
Creator	PASATHORN	.BCP Name	INDEX_C3D_KITCHEN2
Reviewer		Order	I004578
Approves		Date	03/11/2025

No.	Article No.	Description	Mat	Dimension	Cutting Size	Typepology	Skin
0	ESCENT_UB2_DUT950 ESCENT_UB2_DUT950-01	ESCENT_UB2_DUT950 DUT-SP	PB-SP	950x9x60 9x60x950	9X58X950;L2:W0	182000 _STR=05.01 _EDG=WHITE-1	2

Model	ESCENT_UB2_DW75		
Creator	PASATHORN	.BCP Name	INDEX_C3D_KITCHEN2
Reviewer		Order	I004597
Approves	P.SAWAI	Date	04/11/2025

ESCENT_UB2_DW75-750X300X400

Colour

03.41 PVC T.0.13 MM. BEIGE MFI599_ED

-
-
-
-

Edge

01.319 1 MFI599 PEARL _

-
-
-
-



R&D REVIEW	
<input checked="" type="checkbox"/>	DWG.Customer
<input checked="" type="checkbox"/>	Work Report
<input type="checkbox"/>	Function
<input type="checkbox"/>	สินค้าตรงตัวอย่าง
ผู้ทบทวน <u>P.SAWAI</u>	
<u>25/8/2563</u>	

K7L-160170744

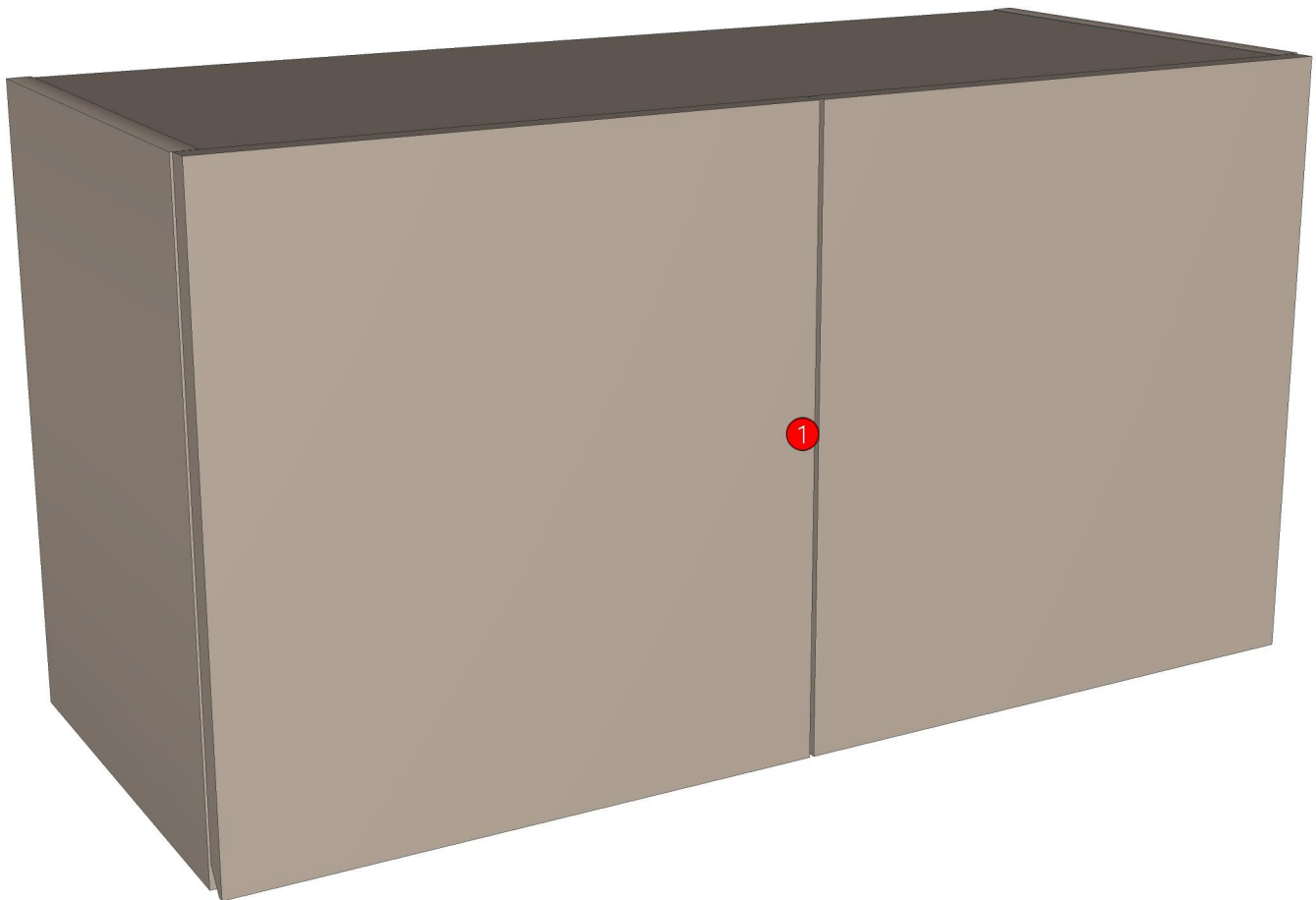

Model	-ESCENT_UB2_DW75		
Creator		.BCP Name	INDEX_C3D_KITCHEN2
Reviewer		Order	I004597
Approves	P. SAWAI	Date	

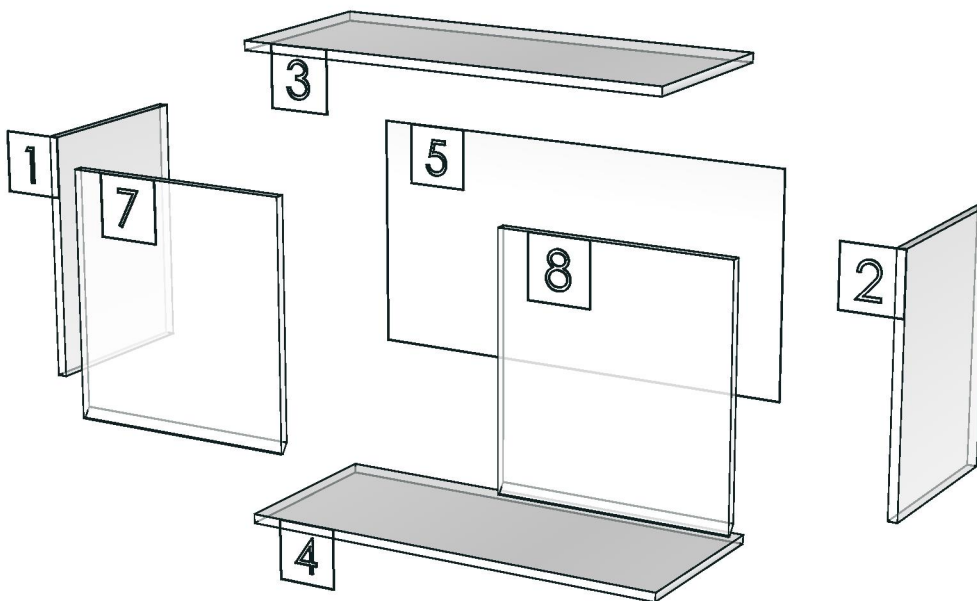

Model	ESCENT_UB2_DWO75		
Creator	PASATHORN	.BCP Name	INDEX_C3D_KITCHEN2
Reviewer		Order	I004601
Approves		Date	04/11/2025

ESCENT_UB2_DWO75-750X300X240

Colour

05.41 ML FOSS ZILK# BK2 (CROSS METAL)_

-
-
-
-

Edge

01.299 1 FOSS ZILK BK2 A1285 TH00 _

-
-
-
-

R&D REVIEW	
<input checked="" type="checkbox"/>	DWG.Customer
<input checked="" type="checkbox"/>	Work Report
<input type="checkbox"/>	Function
<input type="checkbox"/>	สินค้าตรงตัวอย่าง
ผู้ทบทวน _____	

K7L-160170744

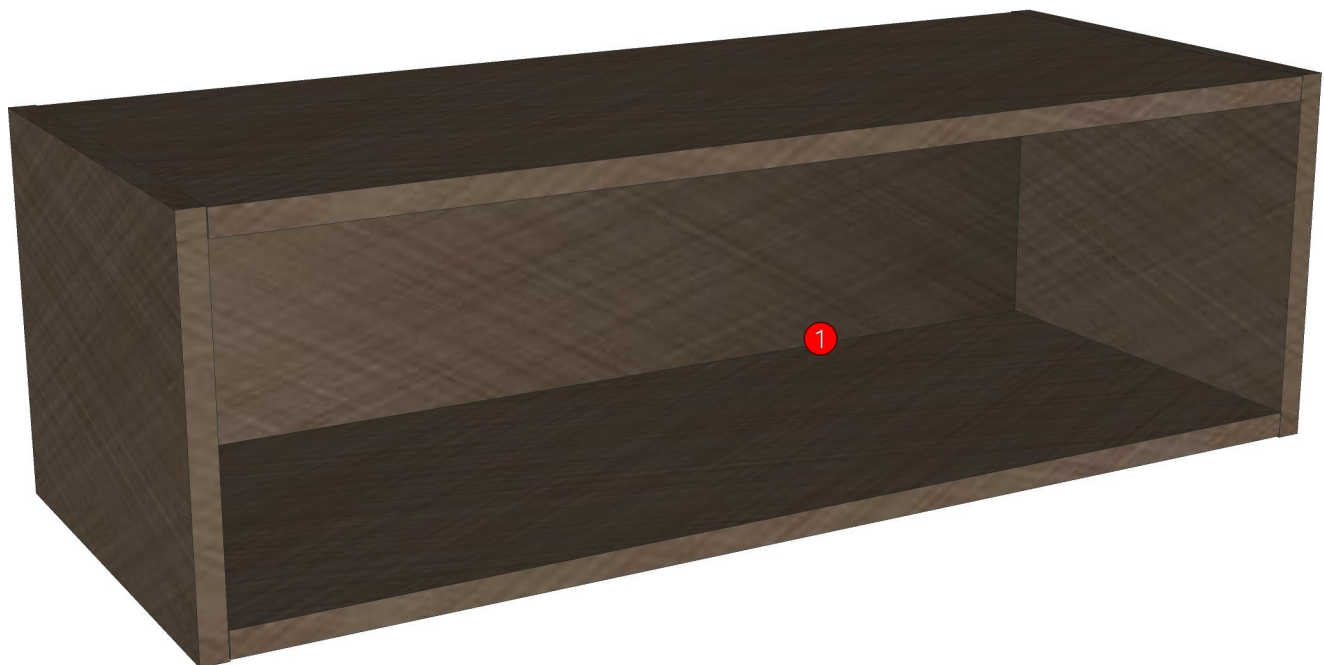

Model	-ESCENT_UB2_DW075		
Creator		.BCP Name	INDEX_C3D_KITCHEN2
Reviewer		Order	I004601
Approves		Date	

