

<b>Model</b>	ESCENT_UB2_DB301L		
<b>Creator</b>	PASATHORN	<b>.BCP Name</b>	INDEX_C3D_KITCHEN2
<b>Reviewer</b>		<b>Order</b>	I004570
<b>Approves</b>	P.SAWAI	<b>Date</b>	03/11/2025

## ESCENT\_UB2\_DB301L-300X570X922

### Colour

03.41 PVC T.0.13 MM.?? BEIGE MFI599\_ED  
05.41 ML FOSS ZILK# BK2 (CROSS METAL)\_  
06.01 TEXTURE DEAD STOCK\_ED

### Edge

01.319 1 MFI599 PEARL \_  
01.299 1 FOSS ZILK BK2 A1285 TH00 \_

ขกเลิก> K4R-160170734



K3R-160170724

<b>R&amp;D REVIEW</b>	
<input checked="" type="checkbox"/>	DWG.Customer
<input checked="" type="checkbox"/>	Work Report
<input type="checkbox"/>	Function
<input type="checkbox"/>	สินค้าตรงตัวอย่าง
ผู้ทบทวน P.SAWAI	
25/8/2563	

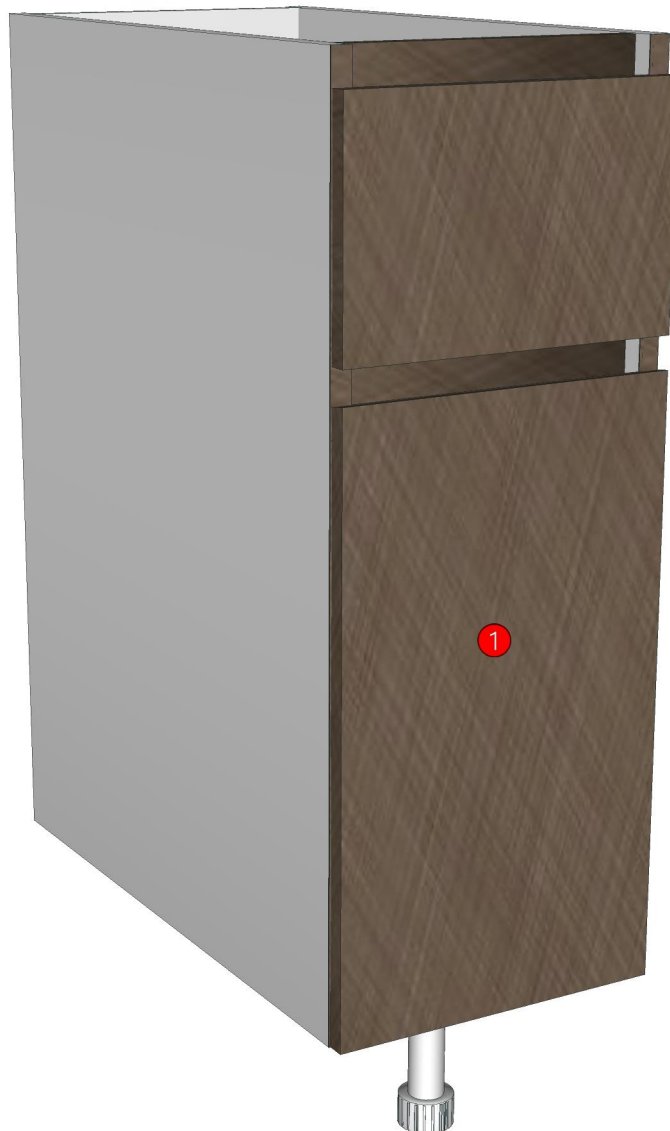

<b>Model</b>	-ESCENT_UB2_DB301L		
<b>Creator</b>		<b>.BCP Name</b>	INDEX_C3D_KITCHEN2
<b>Reviewer</b>		<b>Order</b>	I004570
<b>Approves</b>		<b>Date</b>	

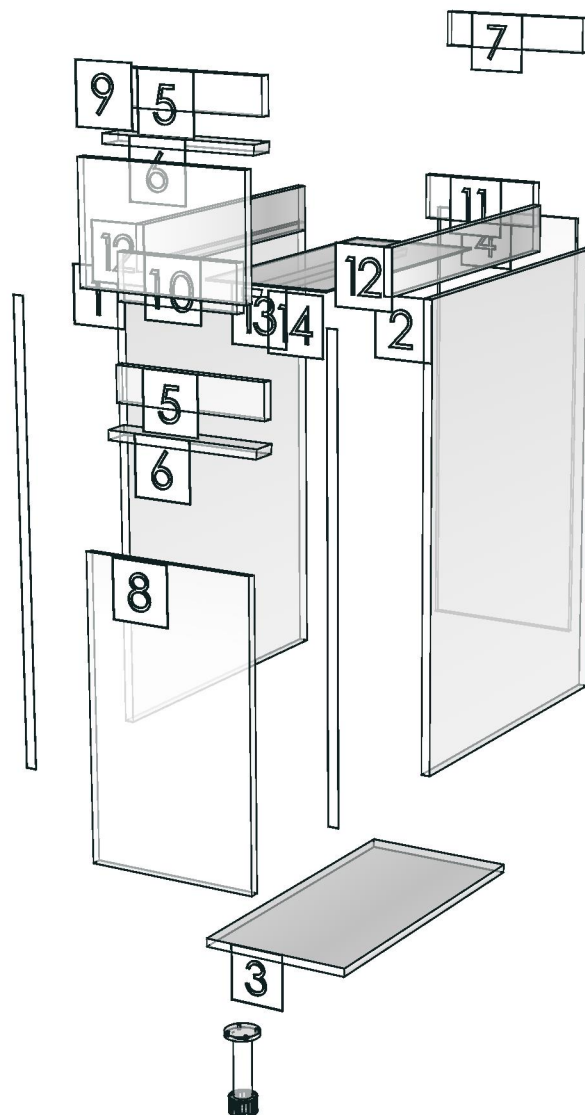

<b>Model</b>	ESCENT_UB2_DBH601R		
<b>Creator</b>	PASATHORN	<b>.BCP Name</b>	INDEX_C3D_KITCHEN2
<b>Reviewer</b>		<b>Order</b>	I003217
<b>Approves</b>		<b>Date</b>	09/07/2024

## ESCENT\_UB2\_DBH601R-600X570X922

### Colour

- 03.41 PVC T.0.13 MM.?? BEIGE MFI599\_ED
- 05.41 ML FOSS ZILK# BK2 (CROSS METAL)\_
- 06.01 TEXTURE DEAD STOCK\_ED
- 
- 

### Edge

- 01.319 1 MFI599 PEARL \_
- 01.299 1 FOSS ZILK BK2 A1285 TH00 \_
- 
- 
- 



**R&D REVIEW**

- DWG.Customer
- Work Report
- Function
- สินค้าตรงตัวอย่าง

ผู้ทบทวน \_\_\_\_\_

K3R-160170724

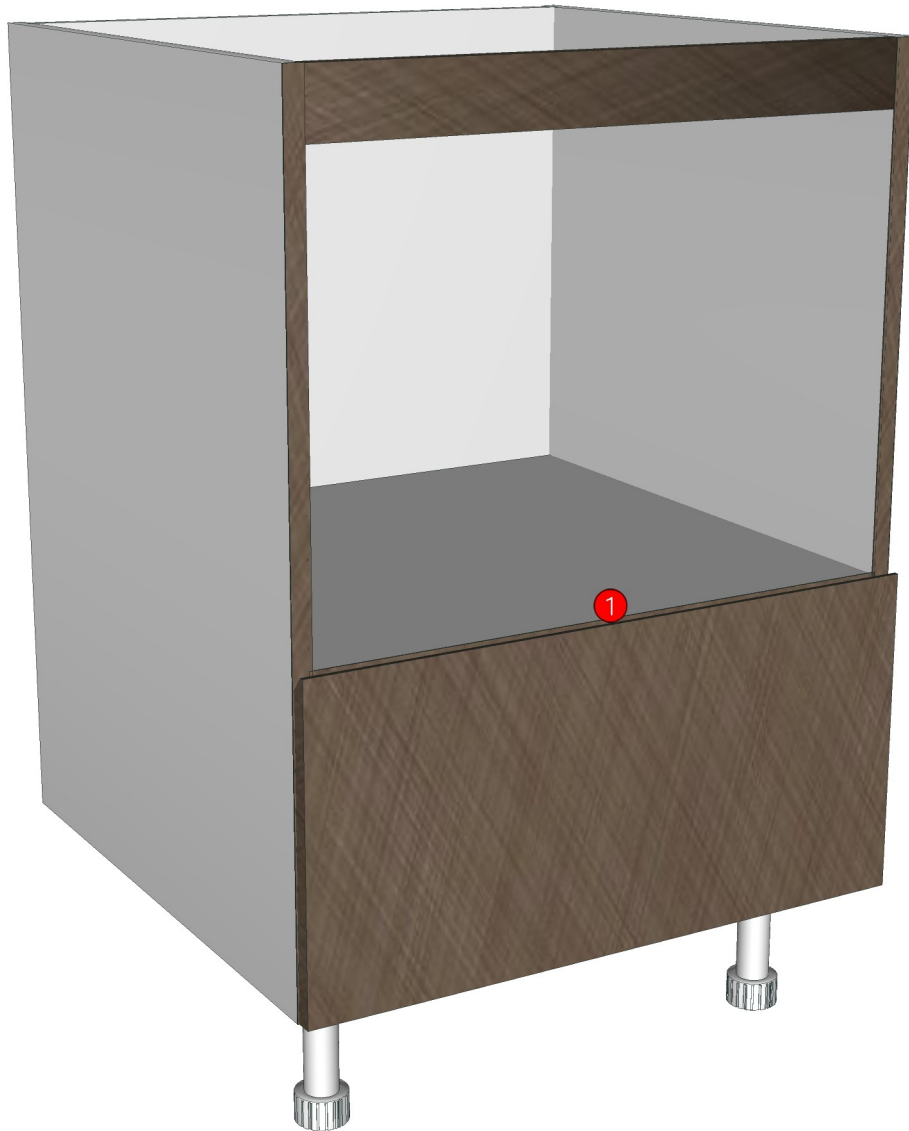

<b>Model</b>	-ESCENT_UB2_DBH601R		
<b>Creator</b>		<b>.BCP Name</b>	INDEX_C3D_KITCHEN2
<b>Reviewer</b>		<b>Order</b>	I003217
<b>Approves</b>		<b>Date</b>	

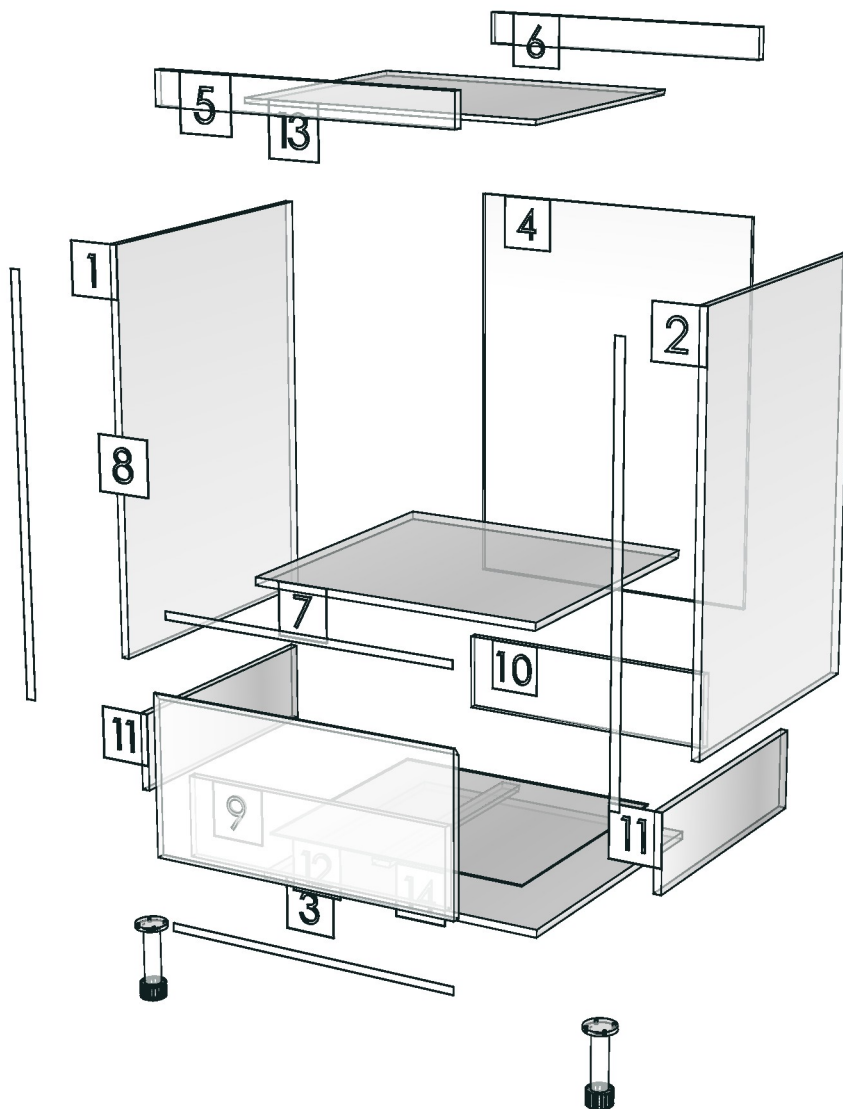

<b>Model</b>	ESCENT_UB2_DBS55R		
<b>Creator</b>	PASATHORN	<b>.BCP Name</b>	INDEX_C3D_KITCHEN2
<b>Reviewer</b>		<b>Order</b>	I004572
<b>Approves</b>		<b>Date</b>	03/11/2025

## ESCENT\_UB2\_DBS55R-550X570X922

### Colour

03.41 PVC T.0.13 MM.?? BEIGE MFI599\_ED  
05.41 ML FOSS ZILK# BK2 (CROSS METAL)\_

-  
-  
-

### Edge

01.319 1 MFI599 PEARL \_  
01.299 1 FOSS ZILK BK2 A1285 TH00 \_

-  
-  
-





<b>R&amp;D REVIEW</b>	
<input checked="" type="checkbox"/>	DWG.Customer
<input checked="" type="checkbox"/>	Work Report
<input type="checkbox"/>	Function
<input type="checkbox"/>	สินค้าตรงตัวอย่าง
ผู้ทบทวน _____	
_____	

K3R-160170724  
K4R-160170734

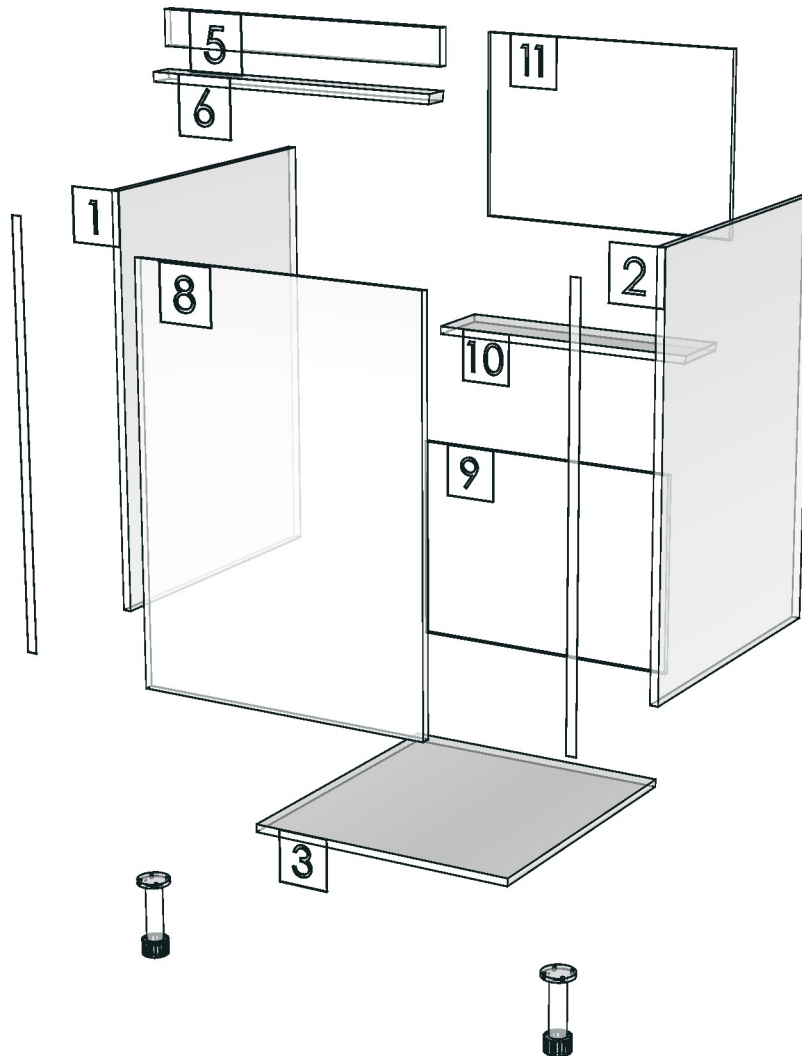

<b>Model</b>	-ESCENT_UB2_DBS55R		
<b>Creator</b>		<b>.BCP Name</b>	INDEX_C3D_KITCHEN2
<b>Reviewer</b>		<b>Order</b>	I004572
<b>Approves</b>		<b>Date</b>	



<b>Model</b>	ESCENT_UB2_DEPB		
<b>Creator</b>	PASATHORN	<b>.BCP Name</b>	INDEX_C3D_KITCHEN2
<b>Reviewer</b>		<b>Order</b>	I003204
<b>Approves</b>		<b>Date</b>	02/07/2024

## ESCENT\_UB2\_DEPB-16X590X772

### Colour

05.41 ML FOSS ZILK# BK2 (CROSS METAL)\_

-

-

-

K1L-160177280\_ED



K1R-160170715

K2L-160177289\_ED



K2R-160147377

K3L-160147386\_ED



K3R-160170724

K4R-160170734

K5L-160177265\_ED



K7L-160170744

K8R-160170757

### Edge

01.299 1 FOSS ZILK BK2 A1285 TH00 \_

-

-

-

-

K9L-160170770

K1100R-160170780



<b>Model</b>	ESCENT_UB2_DEPB		
<b>Creator</b>	PASATHORN	<b>.BCP Name</b>	INDEX_C3D_KITCHEN2
<b>Reviewer</b>		<b>Order</b>	I003204
<b>Approves</b>		<b>Date</b>	02/07/2024

No.	Article No.	Description	Mat	Dimension	Cutting Size	Typepology	Skin
0	ESCENT_UB2_DEPB ESCENT_UB2_DEPB-01	ESCENT_UB2_DEPB DEP-SP	PB-	16x772x590 16x590x772	16X588X770;L2:W2	181000_STR=05.41_EDG=A1285TH00-1	2

<b>Model</b>	ESCENT_UB2_DFB		
<b>Creator</b>	PASATHORN	<b>.BCP Name</b>	INDEX_C3D_KITCHEN2
<b>Reviewer</b>		<b>Order</b>	I003201
<b>Approves</b>		<b>Date</b>	02/07/2024





## ESCENT\_UB2\_DFB-150X16X772

**Colour**

03.41 PVC T.0.13 MM.?? BEIGE MFI599\_ED  
05.41 ML FOSS ZILK# BK2 (CROSS METAL)\_

**Edge**

01.319 1 MFI599 PEARL \_  
01.299 1 FOSS ZILK BK2 A1285 TH00 \_

- 
- 
- K1L-160177280\_ED 
- K1R-160170715
- K2L-160177289\_ED 
- K2R-160147377
- K3L-160147386\_ED 
- K3R-160170724
- K4R-160170734
- K5L-160177265\_ED 
- K7L-160170744
- K8R-160170757

K9L-160170770  
K1100R-160170780

**R&D REVIEW**

- DWG.Customer
- Work Report
- Function
- สินค้าตรงตัวอย่าง

ผู้ทบทวน 



<b>Model</b>	-ESCENT_UB2_DFB		
<b>Creator</b>		<b>.BCP Name</b>	INDEX_C3D_KITCHEN2
<b>Reviewer</b>		<b>Order</b>	I003201
<b>Approves</b>		<b>Date</b>	

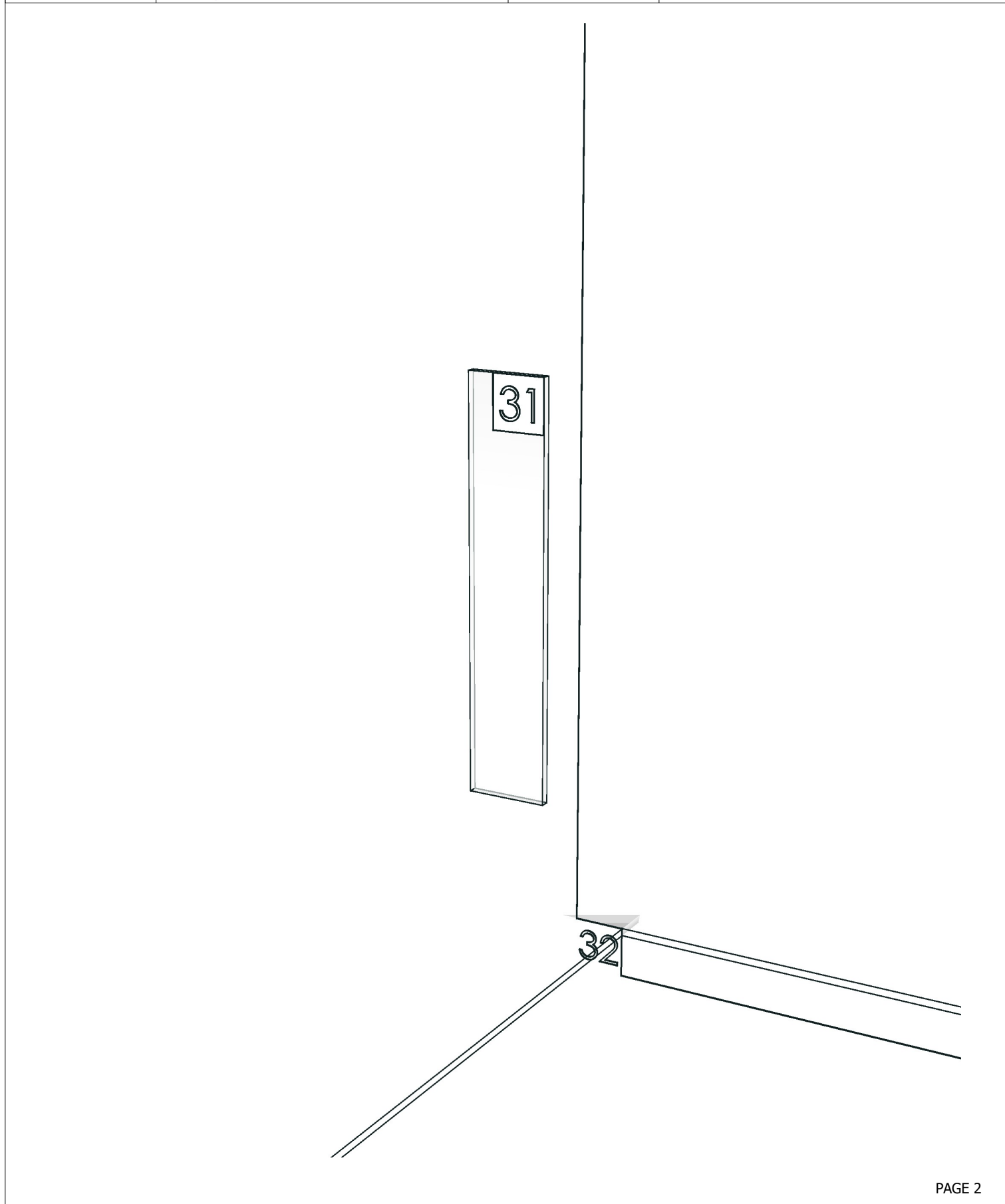

<b>Model</b>	ESCENT_UB2_DFL		
<b>Creator</b>	PASATHORN	<b>.BCP Name</b>	INDEX_C3D_KITCHEN2
<b>Reviewer</b>		<b>Order</b>	I003202
<b>Approves</b>		<b>Date</b>	02/07/2024

## ESCENT\_UB2\_DFL-150X16X640

**Colour**

03.41 PVC T.0.13 MM.?? BEIGE MFI599\_

-  
-  
-  
-

K9L-160170770

K1100R-160170780

**Edge**

01.319 1 MFI599 PEARL \_

-  
-  
-  
-

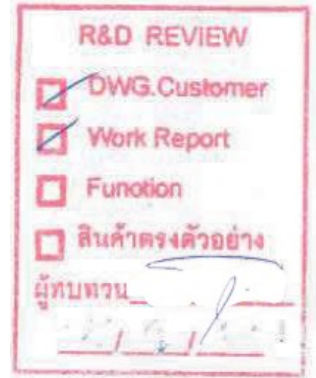

K3L-160147386\_ED

K3R-160170724

K4R-160170734

K5L-160177265\_ED

K8R-160170757

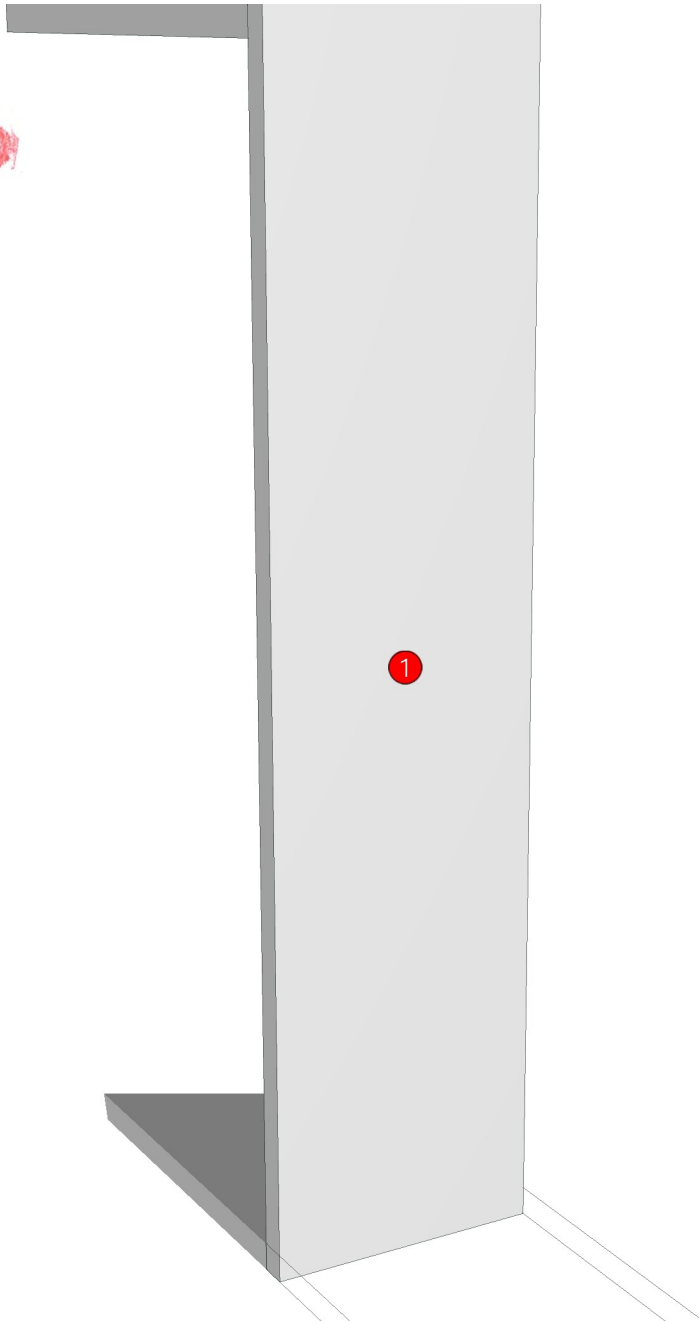

<b>Model</b>	-ESCENT_UB2_DFL		
<b>Creator</b>		<b>.BCP Name</b>	INDEX_C3D_KITCHEN2
<b>Reviewer</b>		<b>Order</b>	I003202
<b>Approves</b>		<b>Date</b>	

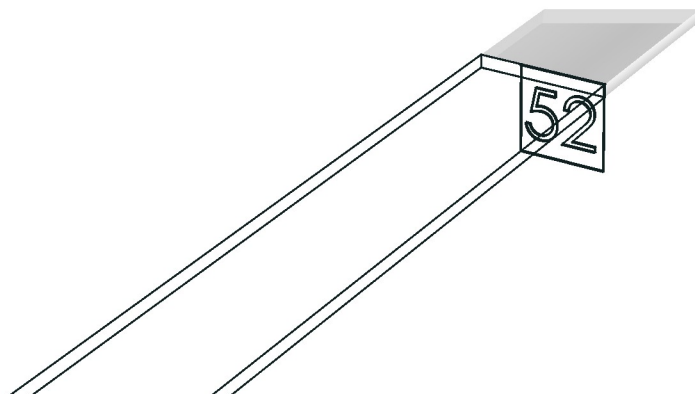
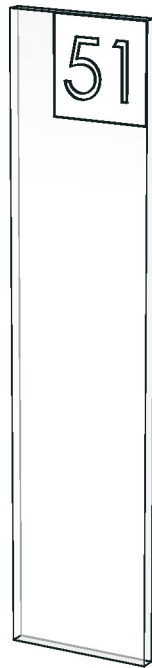
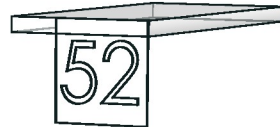

<b>Model</b>	ESCENT_UB2_DF_CL1550		
<b>Creator</b>	PASATHORN	<b>.BCP Name</b>	INDEX_C3D_KITCHEN2
<b>Reviewer</b>		<b>Order</b>	I003200
<b>Approves</b>		<b>Date</b>	02/07/2024

## ESCENT\_UB2\_DF\_CL1550-1550X9X370

**Colour**

03.41 PVC T.0.13 MM.?? BEIGE MFI599\_

-  
-  
-  
-

**Edge**

01.319 1 MFI599 PEARL \_

-  
-  
-  
-



K2L-160177289\_ED



K2R-160147377

K3L-160147386\_ED



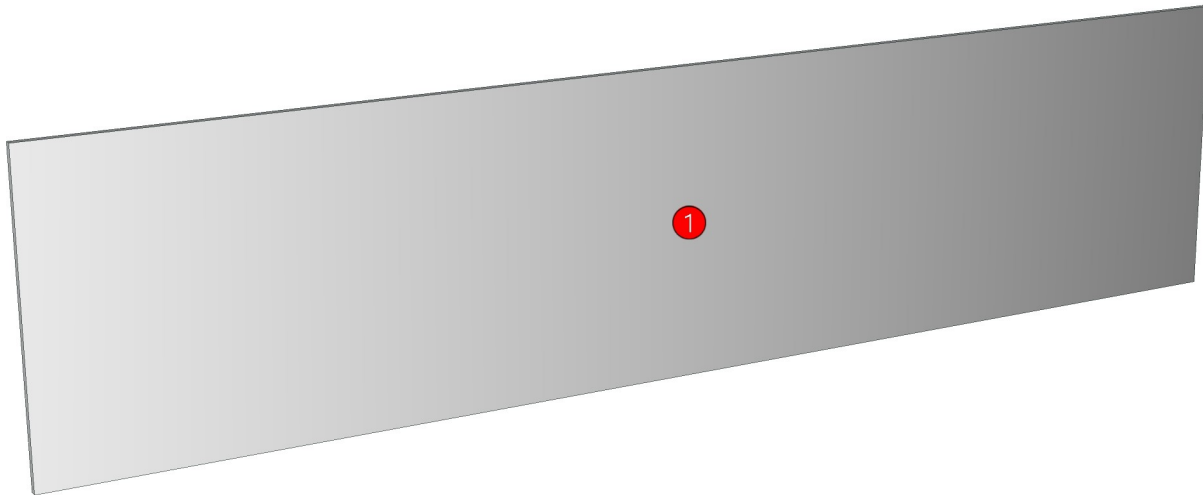

K3R-160170724

K4R-160170734



<b>Model</b>	ESCENT_UB2_DF_CL1550		
<b>Creator</b>	PASATHORN	<b>.BCP Name</b>	INDEX_C3D_KITCHEN2
<b>Reviewer</b>		<b>Order</b>	I003200
<b>Approves</b>		<b>Date</b>	02/07/2024

No.	Article No.	Description	Mat	Dimension	Cutting Size	Typepology	Skin
0	ESCENT_UB2_DF_CL1550	ESCENT_UB2_DF_CL1550		1550x370x9			
	ESCENT_UB2_DF_CL1550-01	DFCL_ED-SP	 PB-ST	9x370x1550	9X369X1549;L1:W1	183000_STR=03.41_EDG=MFI599 PEARL-1	2

<b>Model</b>	ESCENT_UB2_DF_CL525		
<b>Creator</b>	PASATHORN	<b>.BCP Name</b>	INDEX_C3D_KITCHEN2
<b>Reviewer</b>		<b>Order</b>	I003199
<b>Approves</b>		<b>Date</b>	02/07/2024

## ESCENT\_UB2\_DF\_CL525-525X9X370

**Colour**

03.41 PVC T.0.13 MM.?? BEIGE MFI599\_

-  
-  
-  
-

**Edge**

01.319 1 MFI599 PEARL \_

-  
-  
-  
-

K2L-160177289\_ED





K2R-160147377

K3L-160147386\_ED

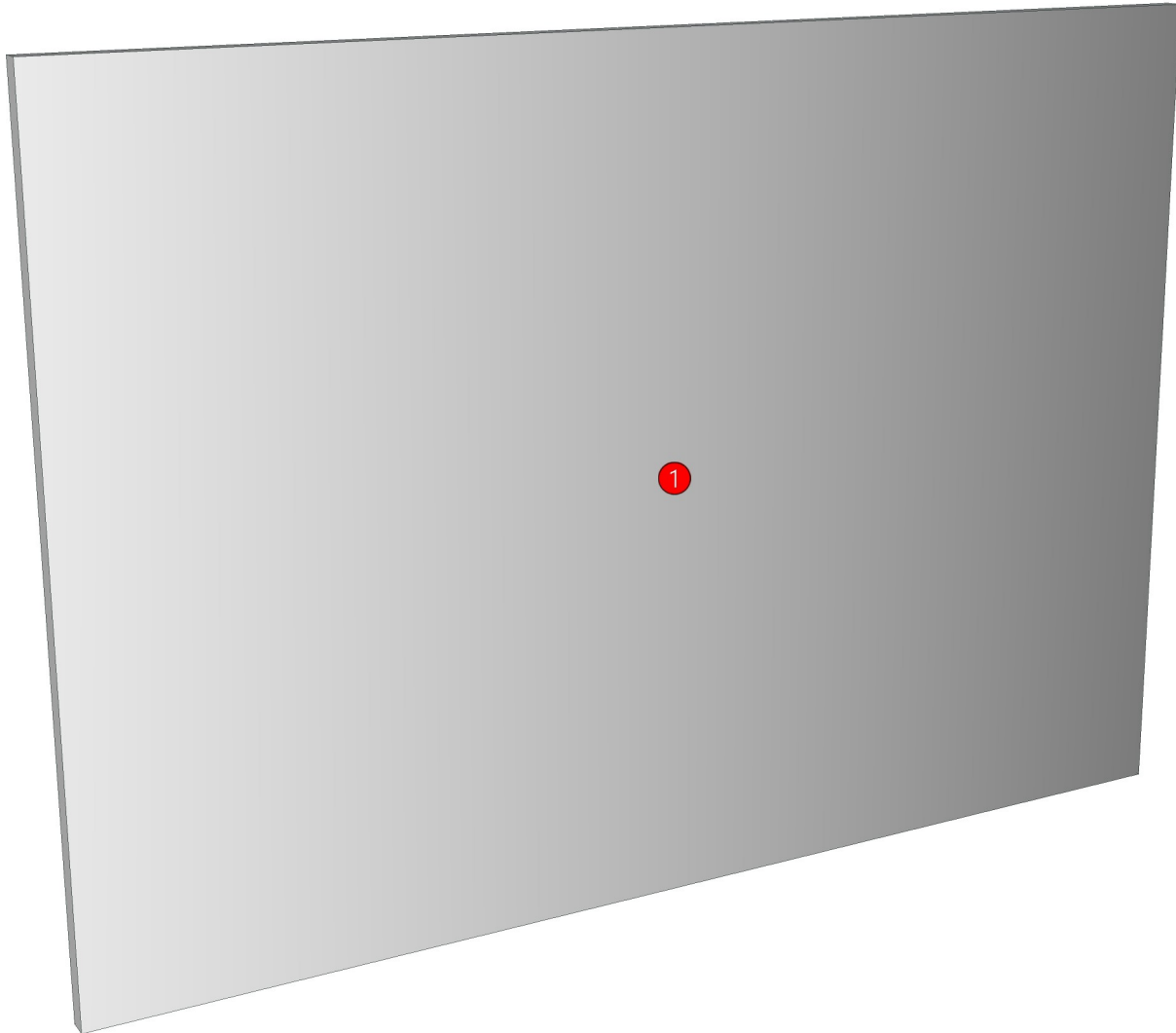

K3R-160170724



<b>Model</b>	ESCENT_UB2_DF_CL525		
<b>Creator</b>	PASATHORN	<b>.BCP Name</b>	INDEX_C3D_KITCHEN2
<b>Reviewer</b>		<b>Order</b>	I003199
<b>Approves</b>		<b>Date</b>	02/07/2024

No.	Article No.	Description	Mat	Dimension	Cutting Size	Typepology	Skin
0	ESCENT_UB2_DF_CL525	ESCENT_UB2_DF_CL525		525x370x9			
	ESCENT_UB2_DF_CL525-01	DFCL_ED-SP	 PB-ST	9x370x525	9X369X524;L1:W1	183000_STR=03.41_EDG=MFI599 PEARL-1	2

<b>Model</b>	ESCENT_UB2_DL60HL		
<b>Creator</b>	PASATHORN	<b>.BCP Name</b>	INDEX_C3D_KITCHEN2
<b>Reviewer</b>		<b>Order</b>	I003207
<b>Approves</b>		<b>Date</b>	03/07/2024

## ESCENT\_UB2\_DL60HL-600X300X600

**Colour**

03.41 PVC T.0.13 MM.?? BEIGE MFI599\_ED

-

-

-

-

K1R-160170715

K1100R-160170780

K2R-160147377

K3R-160170724

K4R-160170734

K8R-160170757

**Edge**

01.319 1 MFI599 PEARL \_

-

-

-

-



**R&D REVIEW**

- DWG.Customer
- Work Report
- Function
- สินค้าตรงตัวอย่าง

ผู้ทบทวน \_\_\_\_\_

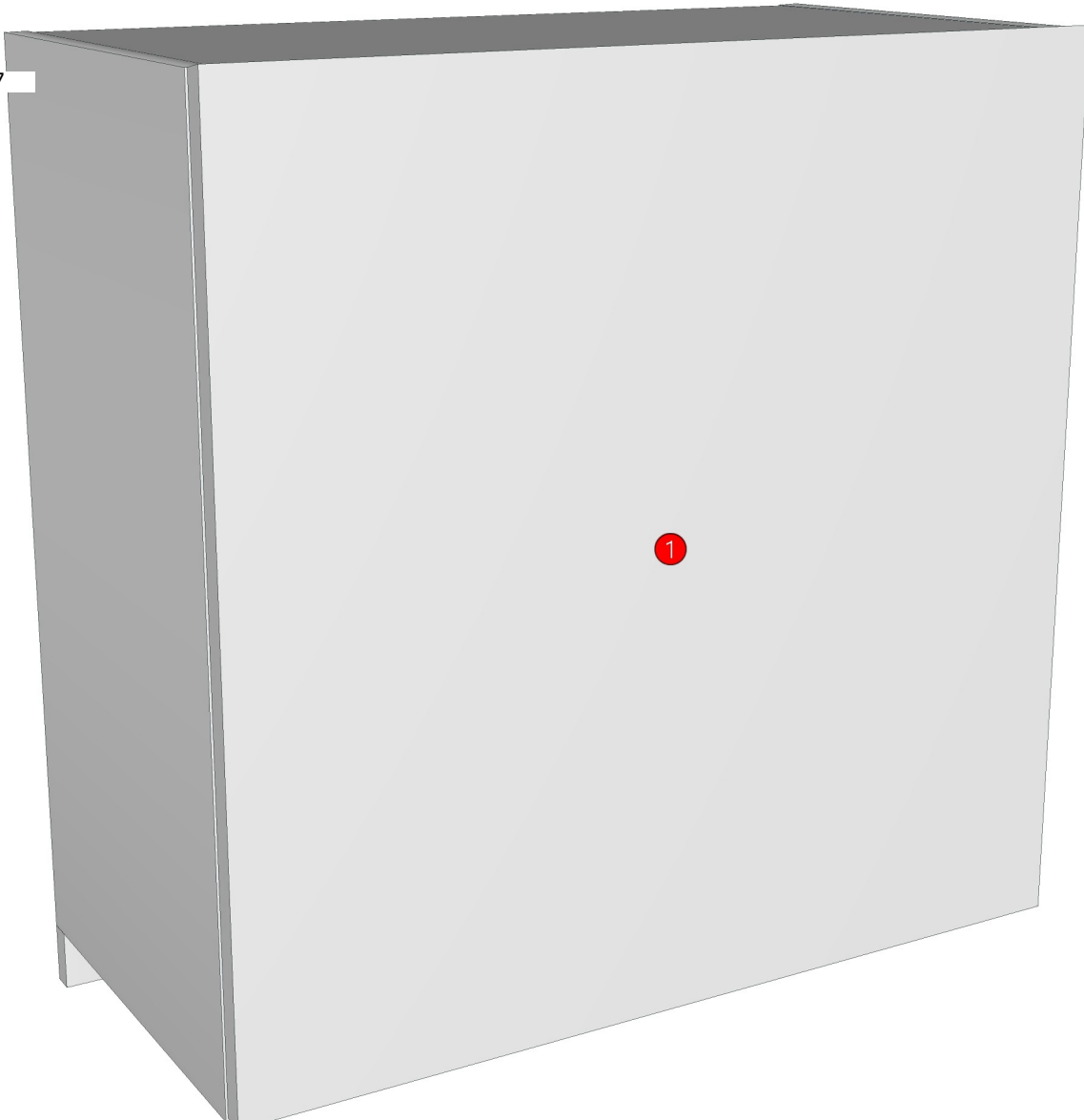

<b>Model</b>	-ESCENT_UB2_DL60HL		
<b>Creator</b>		<b>.BCP Name</b>	INDEX_C3D_KITCHEN2
<b>Reviewer</b>		<b>Order</b>	I003207
<b>Approves</b>		<b>Date</b>	

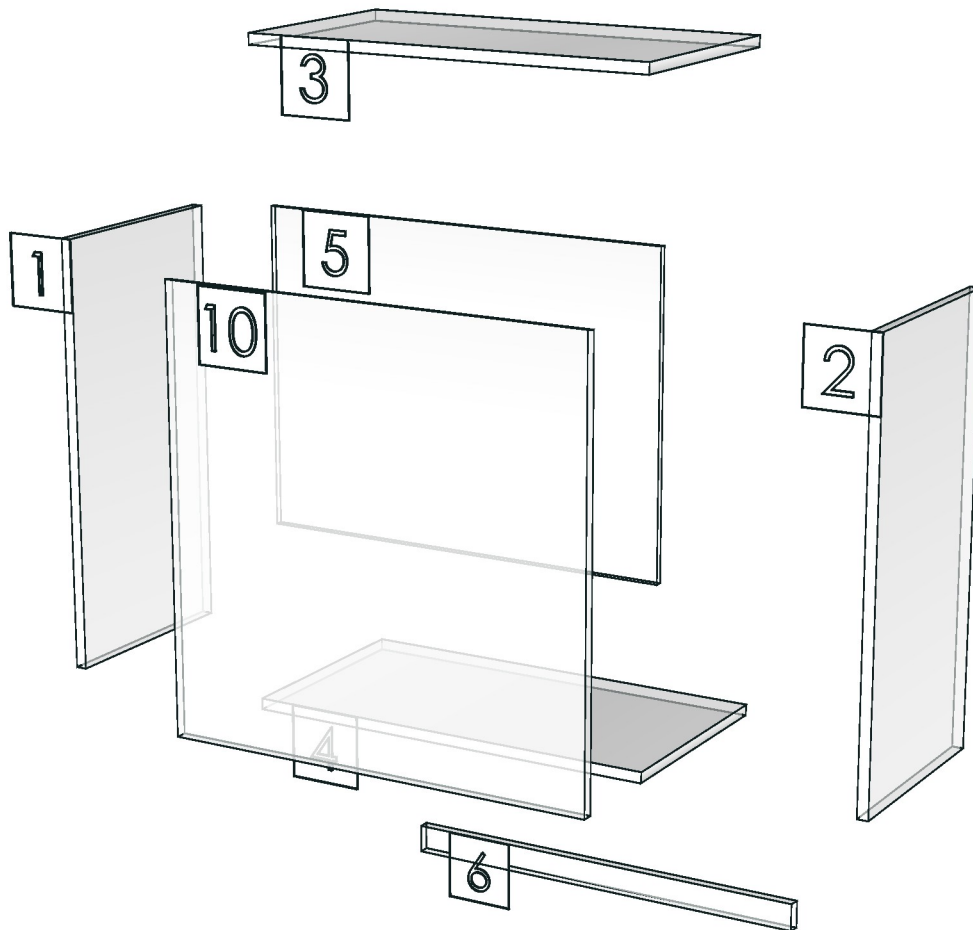

<b>Model</b>	ESCENT_UB2_DUT1550		
<b>Creator</b>	PASATHORN	<b>.BCP Name</b>	INDEX_C3D_KITCHEN2
<b>Reviewer</b>		<b>Order</b>	I004581
<b>Approves</b>		<b>Date</b>	03/11/2025

## ESCENT\_UB2\_DUT1550-1550X60X9

**Colour**

05.01 ML WHITE VM1012 18/18\_

-  
-  
-  
-

**Edge**

01.47 1 WHITE \_

-  
-  
-  
-

K2L-160177289\_ED



K2R-160147377

K3L-160147386\_ED



K3R-160170724

K4R-160170734

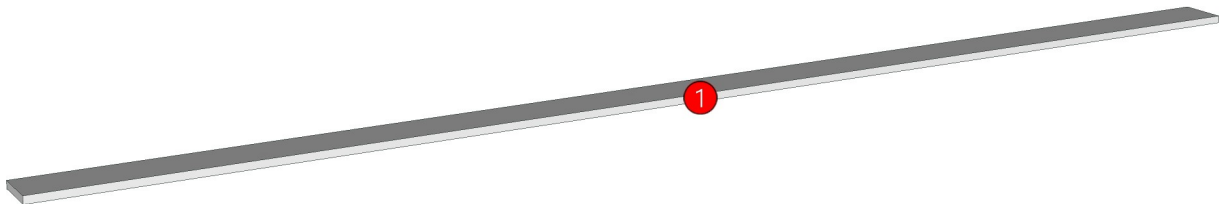

<b>Model</b>	ESCENT_UB2_DUT1550		
<b>Creator</b>	PASATHORN	<b>.BCP Name</b>	INDEX_C3D_KITCHEN2
<b>Reviewer</b>		<b>Order</b>	I004581
<b>Approves</b>		<b>Date</b>	03/11/2025

No.	Article No.	Description	Mat	Dimension	Cutting Size	Typepology	Skin
0	ESCENT_UB2_DUT1550	ESCENT_UB2_DUT1550		1550x9x60			
	ESCENT_UB2_DUT1550-01	DUT-SP	PB-ST	9x60x1550	9X58X1550;L2:W0	182000 _STR=05.01 _EDG=WHITE-1	2

<b>Model</b>	ESCENT_UB2_DUT500		
<b>Creator</b>	PASATHORN	<b>.BCP Name</b>	INDEX_C3D_KITCHEN2
<b>Reviewer</b>		<b>Order</b>	I003197
<b>Approves</b>		<b>Date</b>	02/07/2024

## ESCENT\_UB2\_DUT500-500X60X9

### Colour

05.01 ML WHITE VM1012 18/18\_

-

-

-

K1L-160177280\_ED



K1R-160170715

K2L-160177289\_ED



K2R-160147377

K3L-160147386\_ED



K3R-160170724

K4R-160170734

K5L-160177265\_ED



K7L-160170744

K8R-160170757

### Edge

01.47 1 WHITE \_

-

-

-

-

K9L-160170770

K1100R-160170780

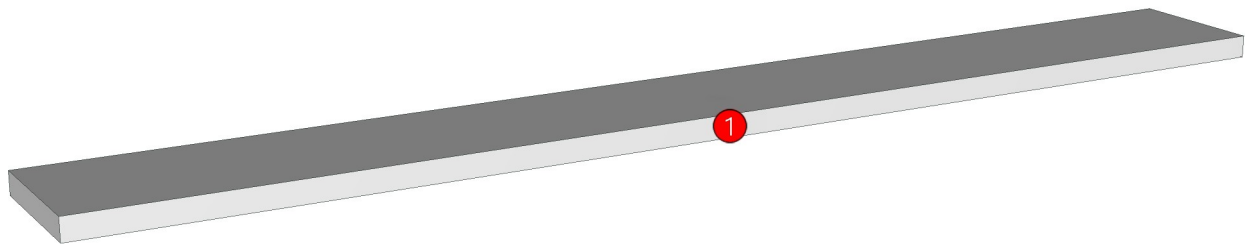
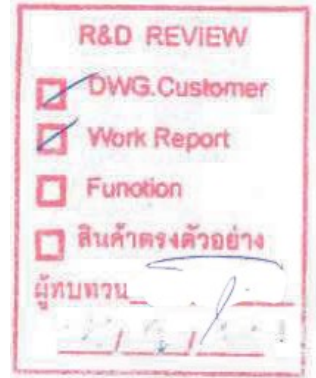

<b>Model</b>	ESCENT_UB2_DUT500		
<b>Creator</b>	PASATHORN	<b>.BCP Name</b>	INDEX_C3D_KITCHEN2
<b>Reviewer</b>		<b>Order</b>	I003197
<b>Approves</b>		<b>Date</b>	02/07/2024

No.	Article No.	Description	Mat	Dimension	Cutting Size	Typepology	Skin
0	ESCENT_UB2_DUT500 ESCENT_UB2_DUT500-01	ESCENT_UB2_DUT500 DUT-SP	PB-ST	500x9x60 9x60x500	9X58X500;L2:W0	182000 _STR=05.01 _EDG=WHITE-1	2

<b>Model</b>	ESCENT_UB2_DW85R		
<b>Creator</b>	PASATHORN	<b>.BCP Name</b>	INDEX_C3D_KITCHEN2
<b>Reviewer</b>		<b>Order</b>	I004575
<b>Approves</b>	P.SAWAI	<b>Date</b>	03/11/2025

## ESCENT\_UB2\_DW85R-850X300X400

### Colour

03.41 PVC T.0.13 MM. BEIGE MFI599\_ED

-  
-  
-  
-

K3R-160170724

K4R-160170734

### Edge

01.319 1 MFI599 PEARL \_

-  
-  
-  
-



**R&D REVIEW**

- DWG.Customer
- Work Report
- Function
- สินค้าตรงตัวอย่าง

ผู้ทบทวน P.SAWAI  
25/11/25

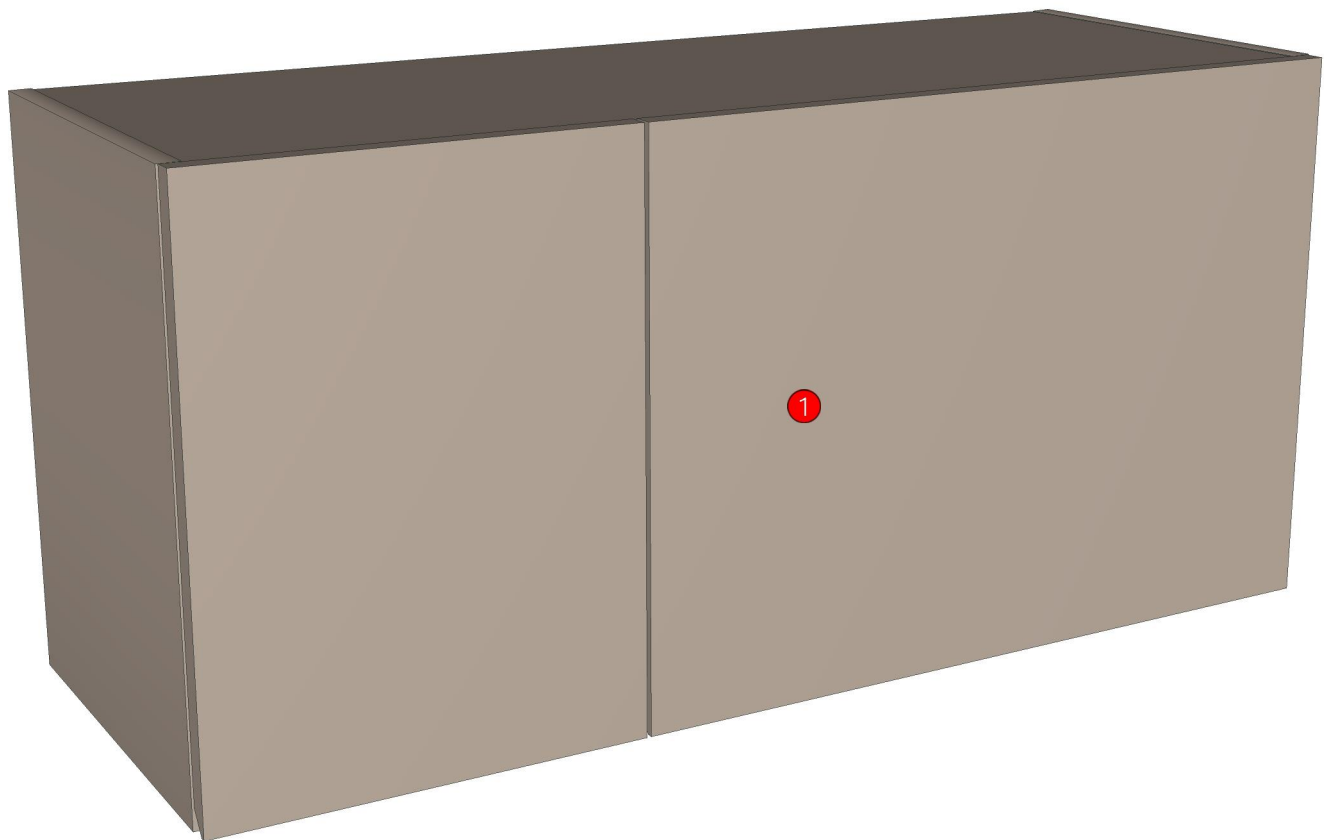

<b>Model</b>	-ESCENT_UB2_DW85R		
<b>Creator</b>		<b>.BCP Name</b>	INDEX_C3D_KITCHEN2
<b>Reviewer</b>		<b>Order</b>	I004575
<b>Approves</b>	P. SAWAI	<b>Date</b>	

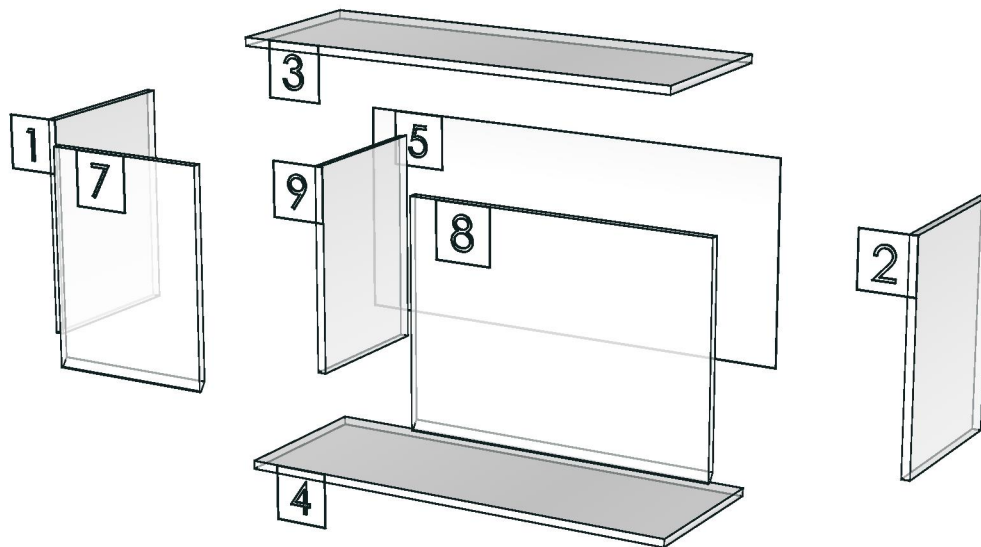

<b>Model</b>	ESCENT_UB2_DWO85		
<b>Creator</b>	PASATHORN	<b>.BCP Name</b>	INDEX_C3D_KITCHEN2
<b>Reviewer</b>		<b>Order</b>	I003210
<b>Approves</b>		<b>Date</b>	03/07/2024

## ESCENT\_UB2\_DWO85-850X300X240

**Colour**

05.41 ML FOSS ZILK# BK2 (CROSS METAL)\_

-  
-  
-  
-

**Edge**

01.299 1 FOSS ZILK BK2 A1285 TH00 \_

-  
-  
-  
-





K3L-160147386\_ED

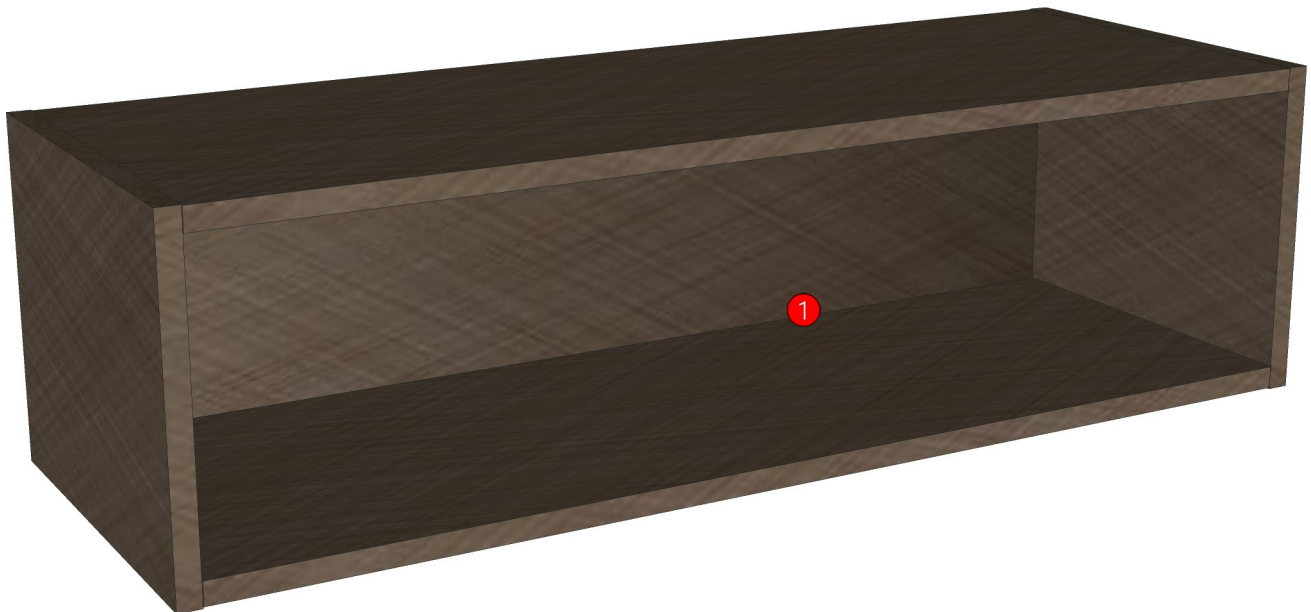

K3R-160170724

K4R-160170734



<b>Model</b>	-ESCENT_UB2_DW085		
<b>Creator</b>		<b>.BCP Name</b>	INDEX_C3D_KITCHEN2
<b>Reviewer</b>		<b>Order</b>	I003210
<b>Approves</b>		<b>Date</b>	

