

Model	ESCENT_UB2_DB20LGRSR		
Creator	PASATHORN	.BCP Name	INDEX_C3D_KITCHEN2
Reviewer		Order	I004609
Approves		Date	06/11/2025

ESCENT_UB2_DB20LGRSR-200X570X922

Colour

03.41 PVC T.0.13 MM. BEIGE MFI599_ED
05.41 ML FOSS ZILK# BK2 (CROSS METAL)_
-
-
K1R-160170715



Edge

01.319 1 MFI599 PEARL _
01.299 1 FOSS ZILK BK2 A1285 TH00 _
-
-
-

R&D REVIEW	
<input checked="" type="checkbox"/>	DWG.Customer
<input checked="" type="checkbox"/>	Work Report
<input type="checkbox"/>	Function
<input type="checkbox"/>	สินค้าตรงตัวอย่าง
ผู้ทบทวน _____	

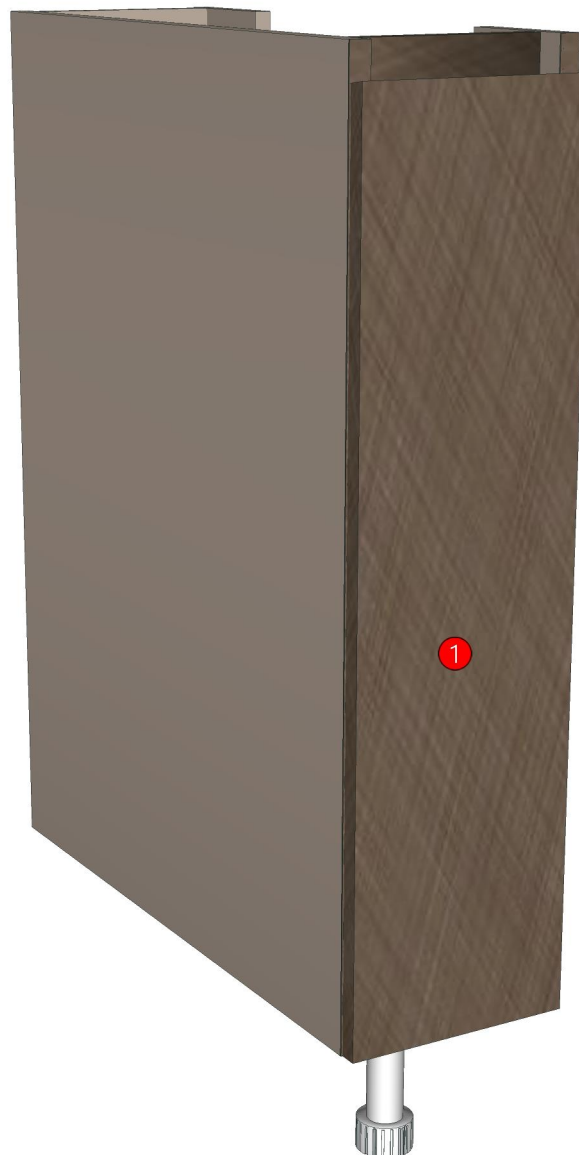

Model	-ESCENT_UB2_DB20LGRSR		
Creator		.BCP Name	INDEX_C3D_KITCHEN2
Reviewer		Order	I004609
Approves		Date	

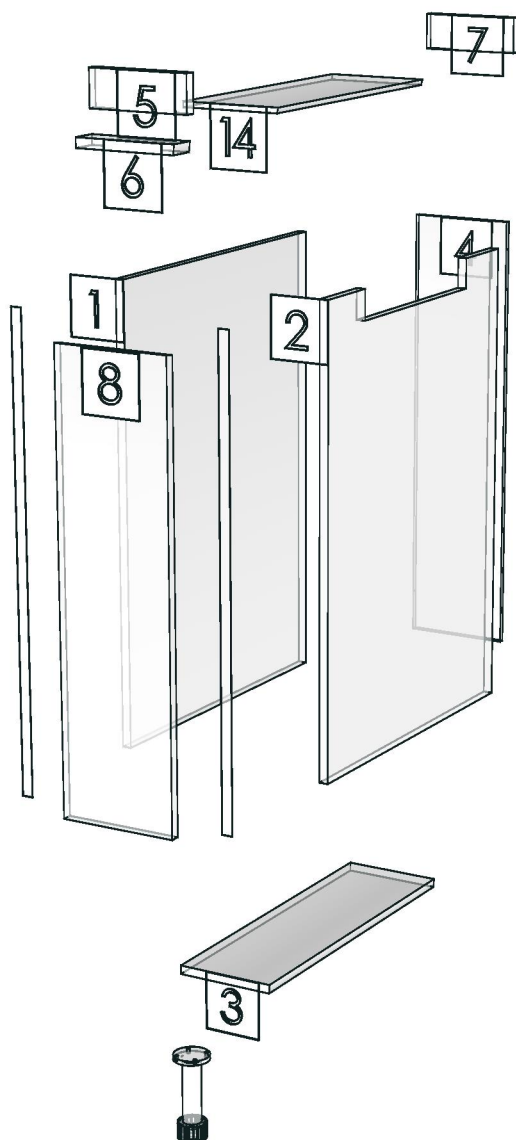

Model	ESCENT_UB2_DBS50RGL		
Creator	PASATHORN	.BCP Name	INDEX_C3D_KITCHEN2
Reviewer		Order	I003214
Approves		Date	04/07/2024

ESCENT_UB2_DBS50RGL-500X570X922

Colour

03.41 PVC T.0.13 MM.?? BEIGE MFI599_ED
05.41 ML FOSS ZILK# BK2 (CROSS METAL)_

-
-
-
K1R-160170715

K2R-160147377

Edge

01.319 1 MFI599 PEARL _
01.299 1 FOSS ZILK BK2 A1285 TH00 _

-
-
-



R&D REVIEW

- DWG.Customer
- Work Report
- Function
- สินค้าตรงตัวอย่าง

ผู้ทบทวน _____

K8R-160170757

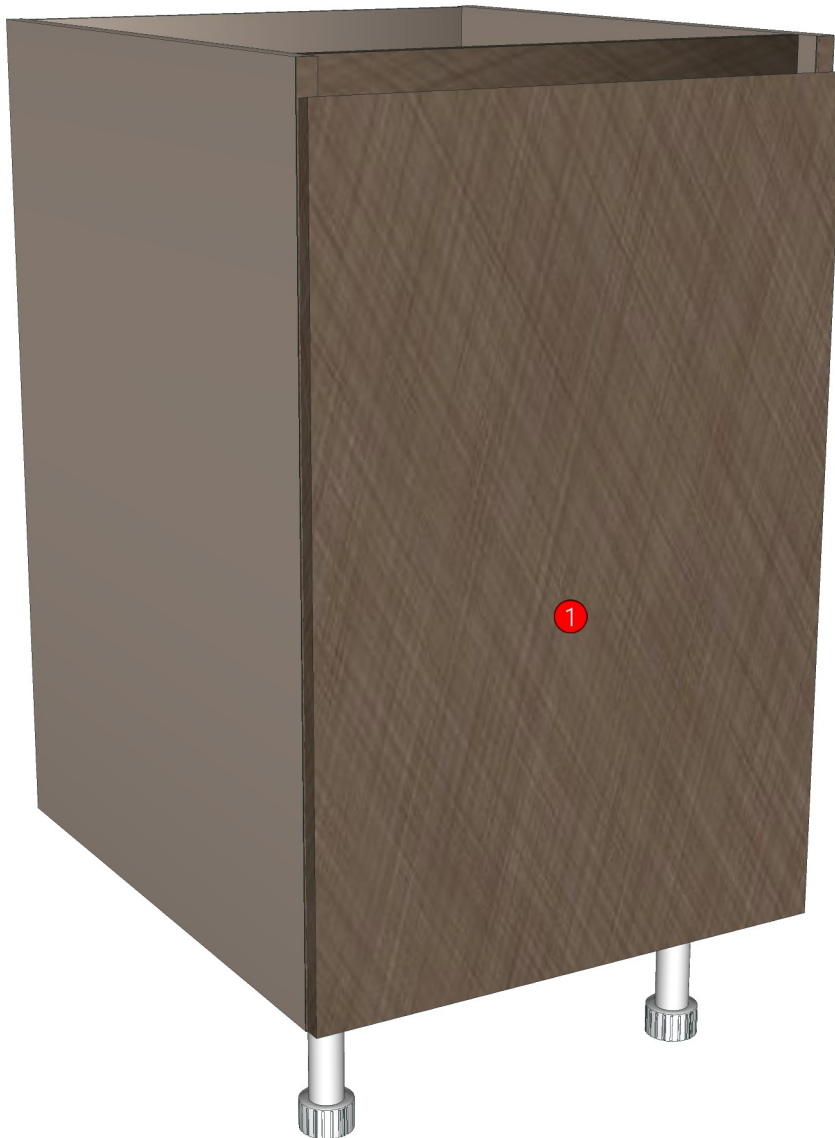

Model	-ESCENT_UB2_DBS50RGL		
Creator		.BCP Name	INDEX_C3D_KITCHEN2
Reviewer		Order	I003214
Approves		Date	

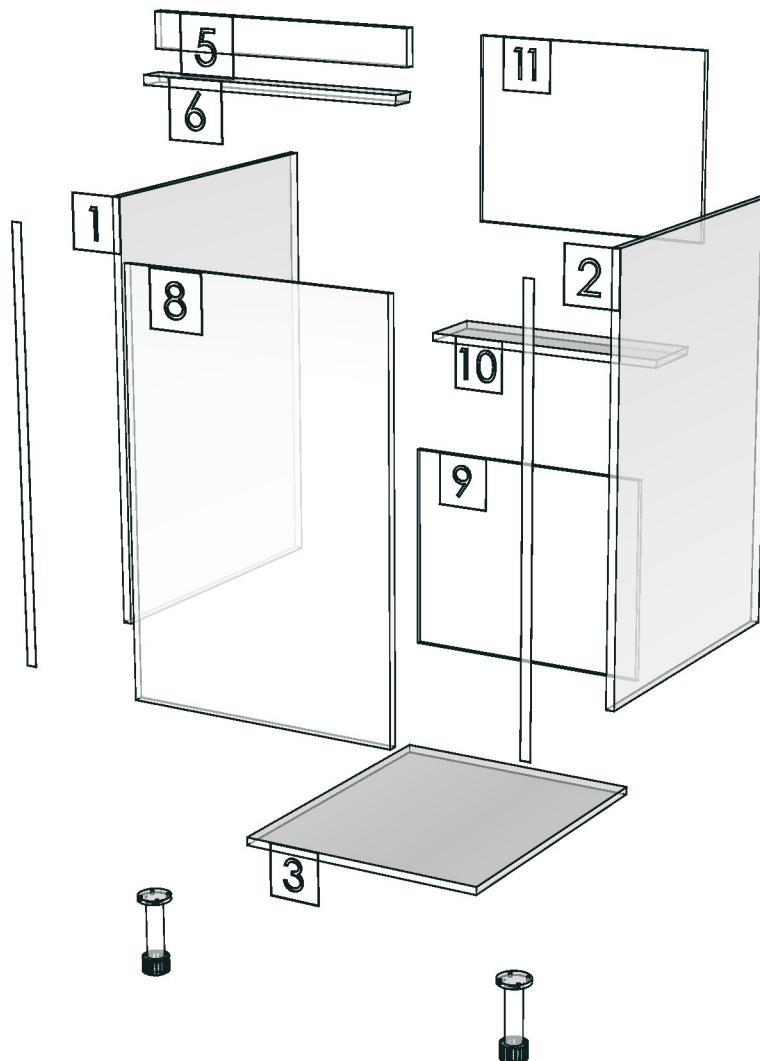

Model	ESCENT_UB2_DEPB		
Creator	PASATHORN	.BCP Name	INDEX_C3D_KITCHEN2
Reviewer		Order	I003204
Approves		Date	02/07/2024

ESCENT_UB2_DEPB-16X590X772

Colour

05.41 ML FOSS ZILK# BK2 (CROSS METAL)_

-

-

-

K1L-160177280_ED



K1R-160170715

K2L-160177289_ED



K2R-160147377

K3L-160147386_ED



K3R-160170724

K4R-160170734

K5L-160177265_ED



K7L-160170744

K8R-160170757

Edge

01.299 1 FOSS ZILK BK2 A1285 TH00 _

-

-

-

-

K9L-160170770

K1100R-160170780



Model	ESCENT_UB2_DEPB		
Creator	PASATHORN	.BCP Name	INDEX_C3D_KITCHEN2
Reviewer		Order	I003204
Approves		Date	02/07/2024

No.	Article No.	Description	Mat	Dimension	Cutting Size	Typepology	Skin
0	ESCENT_UB2_DEPB ESCENT_UB2_DEPB-01	ESCENT_UB2_DEPB DEP-SP	PB-	16x772x590 16x590x772	16X588X770;L2:W2	181000_STR=05.41_EDG=A1285TH00-1	2

Model	ESCENT_UB2_DFB		
Creator	PASATHORN	.BCP Name	INDEX_C3D_KITCHEN2
Reviewer		Order	I003201
Approves		Date	02/07/2024





ESCENT_UB2_DFB-150X16X772

Colour

03.41 PVC T.0.13 MM.?? BEIGE MFI599_ED
05.41 ML FOSS ZILK# BK2 (CROSS METAL)_

Edge

01.319 1 MFI599 PEARL _
01.299 1 FOSS ZILK BK2 A1285 TH00 _

-
-
- K1L-160177280_ED  K9L-160170770
- K1R-160170715  K1100R-160170780
- K2L-160177289_ED 
- K2R-160147377
- K3L-160147386_ED 
- K3R-160170724
- K4R-160170734
- K5L-160177265_ED 
- K7L-160170744
- K8R-160170757



Model	-ESCENT_UB2_DFB		
Creator		.BCP Name	INDEX_C3D_KITCHEN2
Reviewer		Order	I003201
Approves		Date	

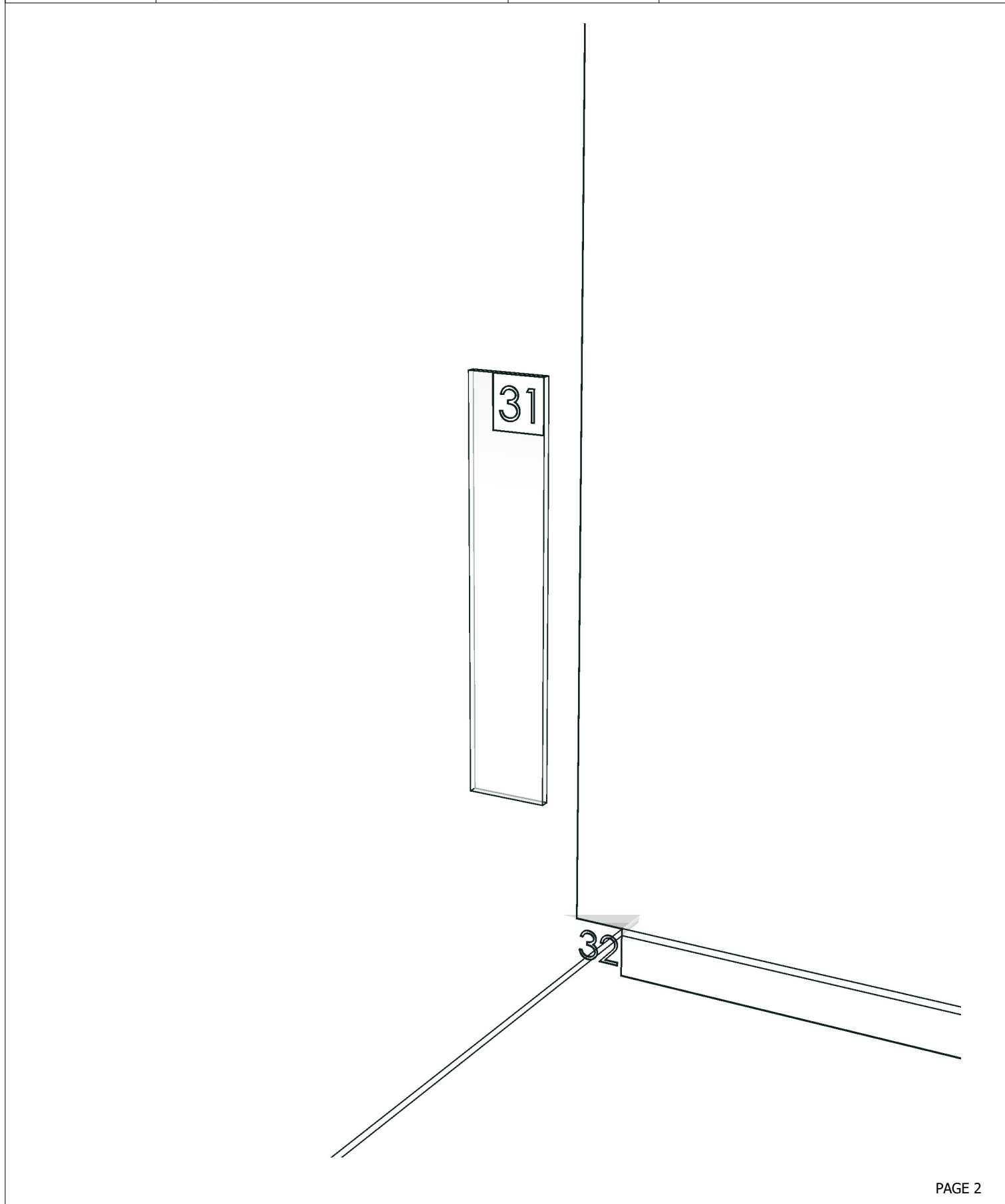

Model	ESCENT_UB2_DFLMV		
Creator	PASATHORN	.BCP Name	INDEX_C3D_KITCHEN2
Reviewer		Order	I003203
Approves		Date	02/07/2024

ESCENT_UB2_DFLMV-150X16X800

Colour

03.41 PVC T.0.13 MM.?? BEIGE MFI599_

-

-

K1L-160177280_ED



K1R-160170715

K2L-160177289_ED



K2R-160147377

Edge

01.319 1 MFI599 PEARL _

-

-

-

-

K1100R-160170780



K7L-160170744

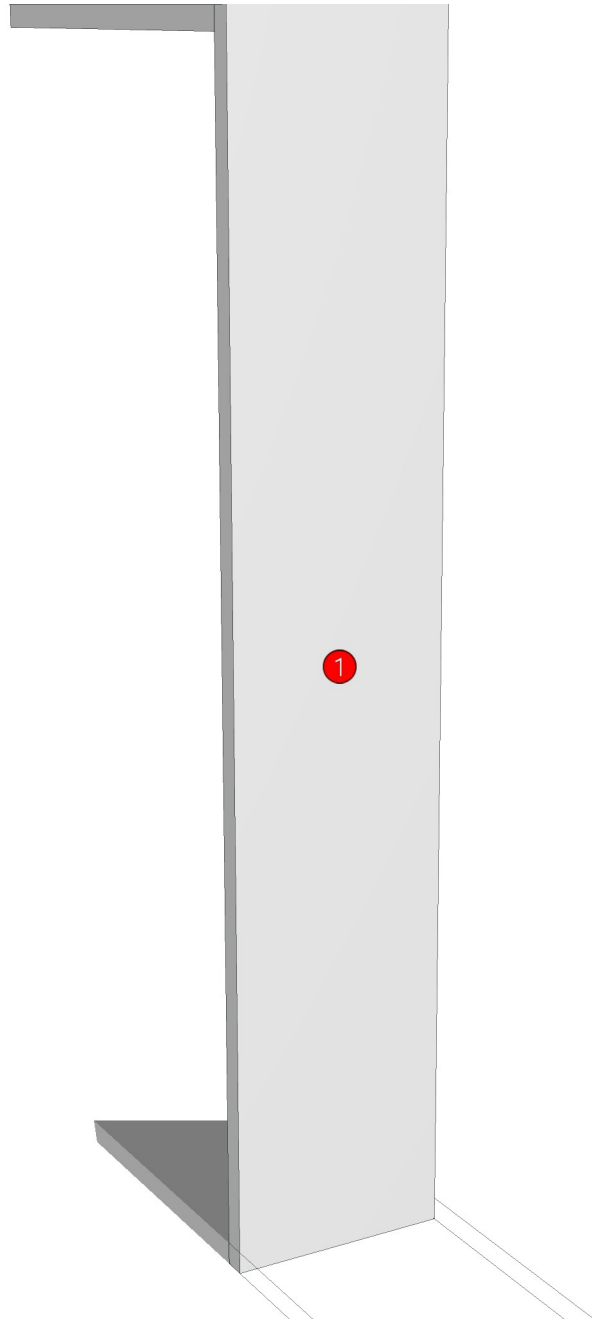

Model	-ESCENT_UB2_DFLMV		
Creator		.BCP Name	INDEX_C3D_KITCHEN2
Reviewer		Order	I003203
Approves		Date	

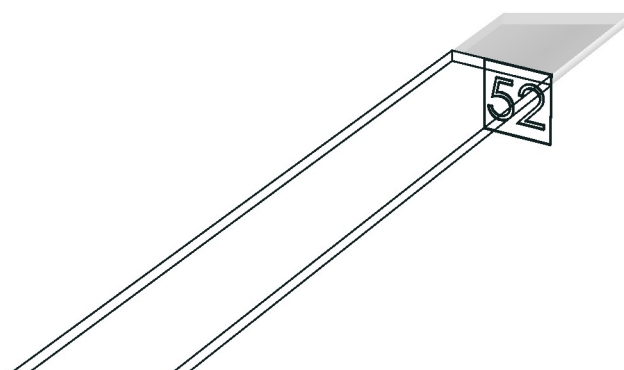
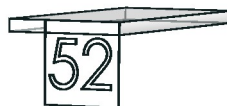

Model	ESCENT_UB2_DF_CL1500		
Creator	PASATHORN	.BCP Name	INDEX_C3D_KITCHEN2
Reviewer		Order	I004589
Approves		Date	04/11/2025

ESCENT_UB2_DF_CL1500-1500X9X370

Colour

03.41 PVC T.0.13 MM.?? BEIGE MFI599_

-

-

-

K1L-160177280_ED



K1R-160170715

Edge

01.319 1 MFI599 PEARL _

-

-

-

-

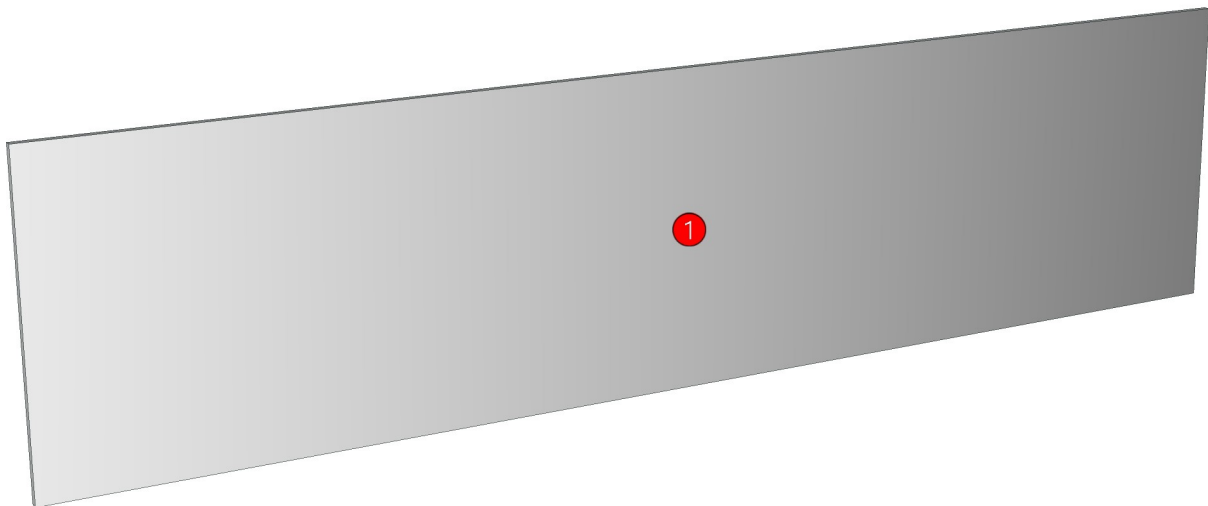

Model	ESCENT_UB2_DF_CL1500		
Creator	PASATHORN	.BCP Name	INDEX_C3D_KITCHEN2
Reviewer		Order	I004589
Approves		Date	04/11/2025

No.	Article No.	Description	Mat	Dimension	Cutting Size	Typepology	Skin
0	ESCENT_UB2_DF_	ESCENT_UB2_DF_CL1500		1500x370x9			
	ESCENT_UB2_DF_CL1500-01	DFCL_ED-SP	 PB-ST	9x370x1500	9X369X1499;L1:W1	183000_STR=03.41 _EDG=MFI599 PEARL-1	2

Model	ESCENT_UB2_DF_CL300		
Creator	PASATHORN	.BCP Name	INDEX_C3D_KITCHEN2
Reviewer		Order	I004584
Approves		Date	04/11/2025

ESCENT_UB2_DF_CL300-300X9X370

Colour

03.41 PVC T.0.13 MM.?? BEIGE MFI599_

-

-

-

K1L-160177280_ED



K1R-160170715

K9L-160170770

K1100R-160170780

Edge

01.319 1 MFI599 PEARL _

-

-

-

-

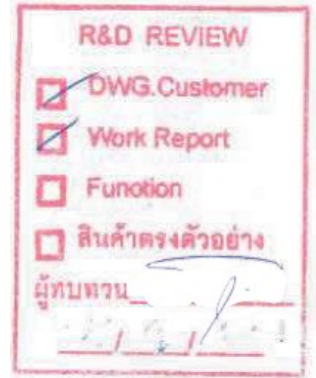



K4R-160170734

K5L-160177265_ED

K7L-160170744

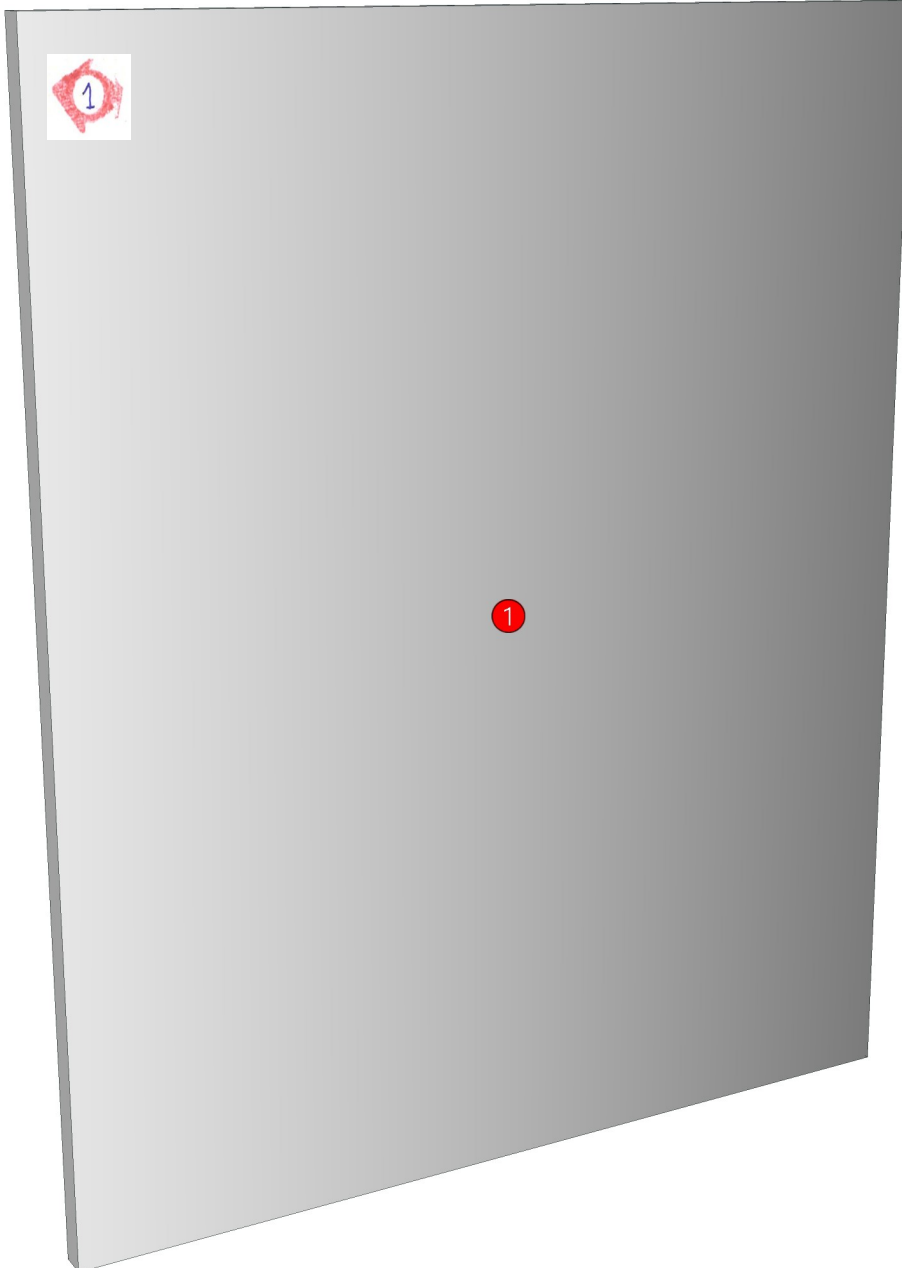
K8R-160170757



Model	ESCENT_UB2_DF_CL300		
Creator	PASATHORN	.BCP Name	INDEX_C3D_KITCHEN2
Reviewer		Order	I004584
Approves		Date	04/11/2025

No.	Article No.	Description	Mat	Dimension	Cutting Size	Typepology	Skin
0	ESCENT_UB2_DF_	ESCENT_UB2_DF_CL300		300x370x9			
	ESCENT_UB2_DF_CL300-01	DFCL_ED-SP	 PB-ST	9x370x300	9X369X299;L1:W1	183000_STR=03.41_EDG=MFI599 PEARL-1	2

Model	ESCENT_UB2_DL60HL		
Creator	PASATHORN	.BCP Name	INDEX_C3D_KITCHEN2
Reviewer		Order	I003207
Approves		Date	03/07/2024

ESCENT_UB2_DL60HL-600X300X600

Colour

03.41 PVC T.0.13 MM.?? BEIGE MFI599_ED

Edge

01.319 1 MFI599 PEARL _



-
-
-
-

K1R-160170715

K1100R-160170780

K2R-160147377

K3R-160170724

K4R-160170734

K8R-160170757

R&D REVIEW

- DWG.Customer
- Work Report
- Function
- สินค้าตรงตัวอย่าง

ผู้ทบทวน _____

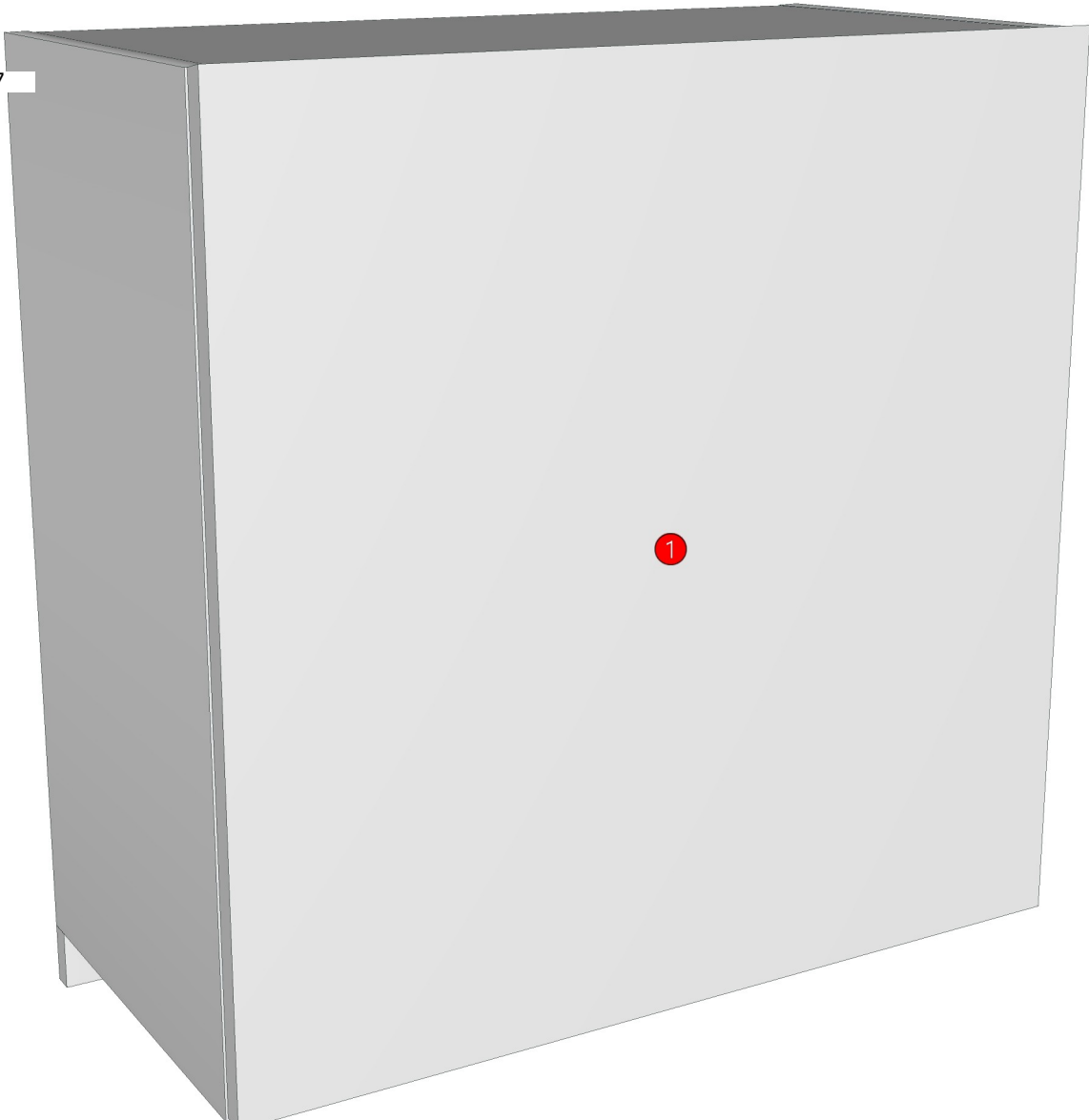

Model	-ESCENT_UB2_DL60HL		
Creator		.BCP Name	INDEX_C3D_KITCHEN2
Reviewer		Order	I003207
Approves		Date	

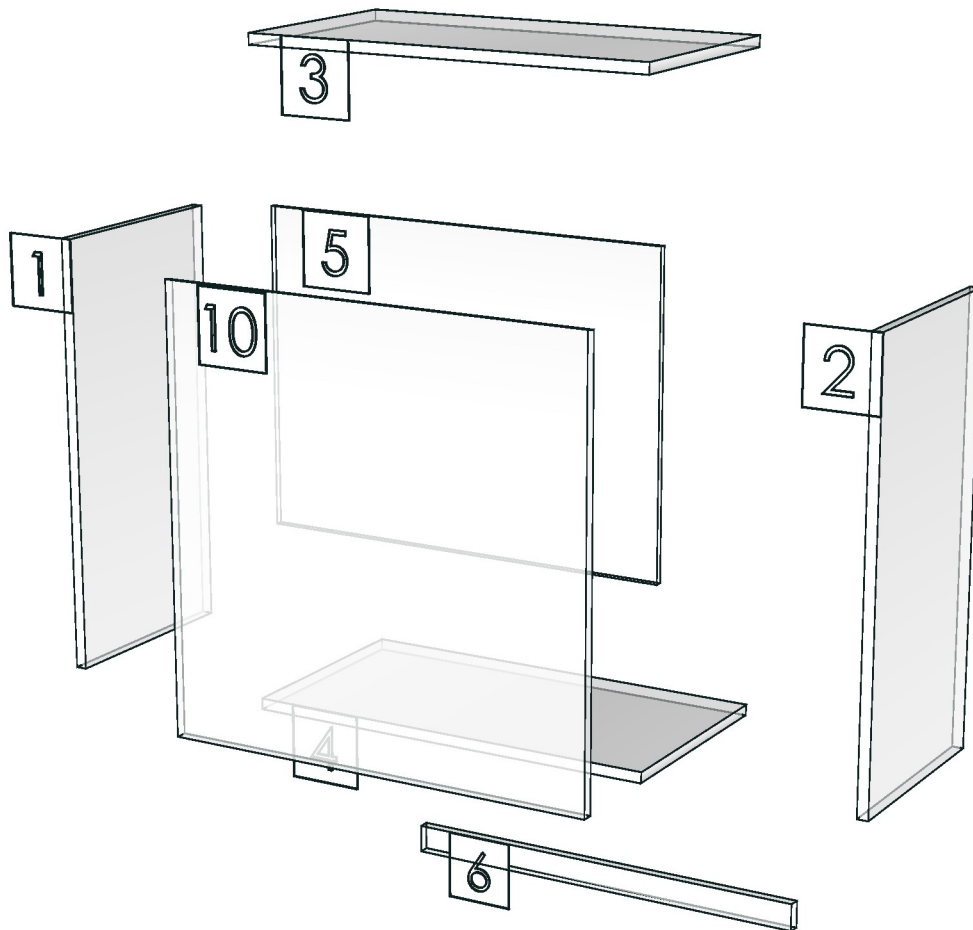

Model	ESCENT_UB2_DLMV75R		
Creator	PASATHORN	.BCP Name	INDEX_C3D_KITCHEN2
Reviewer		Order	I004605
Approves		Date	06/11/2025

ESCENT_UB2_DLMV75R-750X350X800

Colour

03.41 PVC T.0.13 MM.?? BEIGE MFI599_ED

-

-

-

-

K1R-160170715

Edge

01.319 1 MFI599 PEARL _

-

-

-

-



R&D REVIEW	
<input checked="" type="checkbox"/>	DWG.Customer
<input checked="" type="checkbox"/>	Work Report
<input type="checkbox"/>	Function
<input type="checkbox"/>	สินค้าตรงตัวอย่าง
ผู้ทบทวน _____	

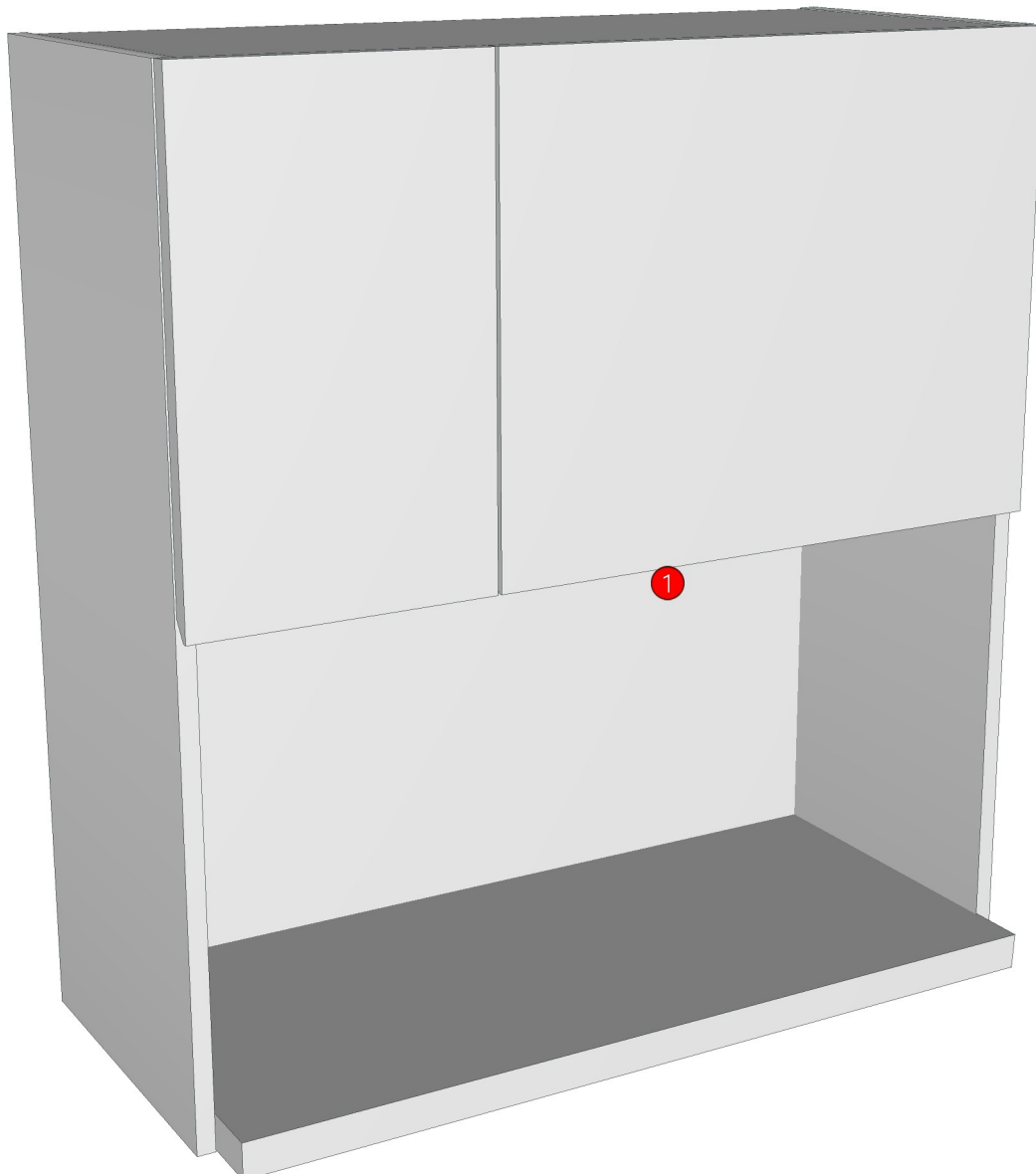

Model	-ESCENT_UB2_DLMV75R		
Creator		.BCP Name	INDEX_C3D_KITCHEN2
Reviewer		Order	I004605
Approves		Date	

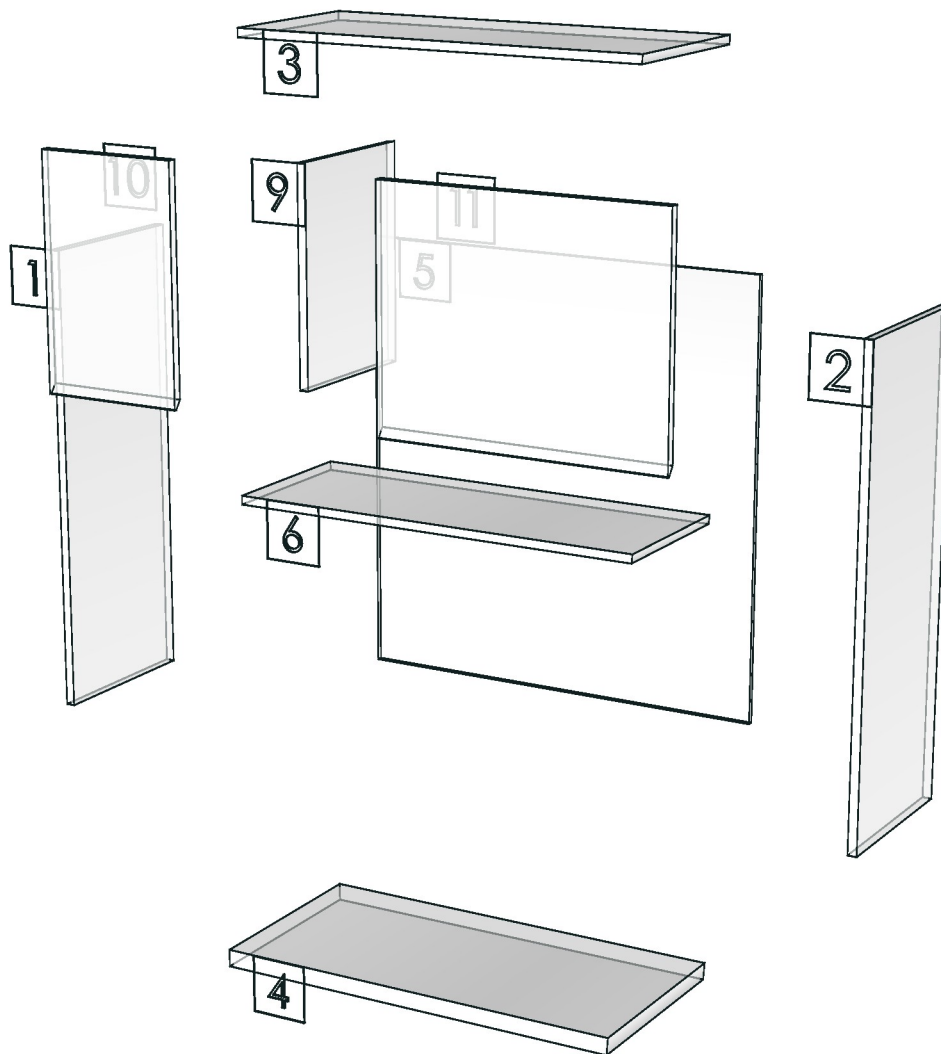

Model	ESCENT_UB2_DUT1500		
Creator	PASATHORN	.BCP Name	INDEX_C3D_KITCHEN2
Reviewer		Order	I003198
Approves		Date	02/07/2024

ESCENT_UB2_DUT1500-1500X60X9

Colour

05.01 ML WHITE VM1012 18/18_

-

-

-

K1L-160177280_ED



K1R-160170715

Edge

01.47 1 WHITE _

-

-

-

-

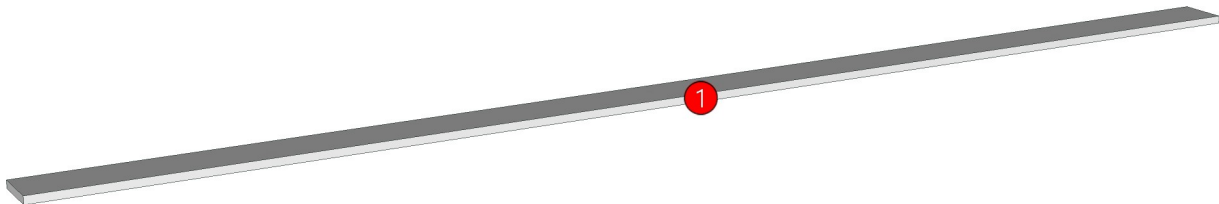

Model	ESCENT_UB2_DUT1500		
Creator	PASATHORN	.BCP Name	INDEX_C3D_KITCHEN2
Reviewer		Order	I003198
Approves		Date	02/07/2024

No.	Article No.	Description	Mat	Dimension	Cutting Size	Typepology	Skin
0	ESCENT_UB2_DUT1500	ESCENT_UB2_DUT1500		1500x9x60			
	ESCENT_UB2_DUT1500-01	DUT-SP	PB-ST	9x60x1500	9X58X1500;L2:W0	182000 _STR=05.01 _EDG=WHITE-1	2

Model	ESCENT_UB2_DUT500		
Creator	PASATHORN	.BCP Name	INDEX_C3D_KITCHEN2
Reviewer		Order	I003197
Approves		Date	02/07/2024

ESCENT_UB2_DUT500-500X60X9

Colour

05.01 ML WHITE VM1012 18/18_

-

-

-

K1L-160177280_ED



K1R-160170715

K2L-160177289_ED



K2R-160147377

K3L-160147386_ED



K3R-160170724

K4R-160170734

K5L-160177265_ED



K7L-160170744

K8R-160170757

Edge

01.47 1 WHITE _

-

-

-

-

K9L-160170770

K1100R-160170780

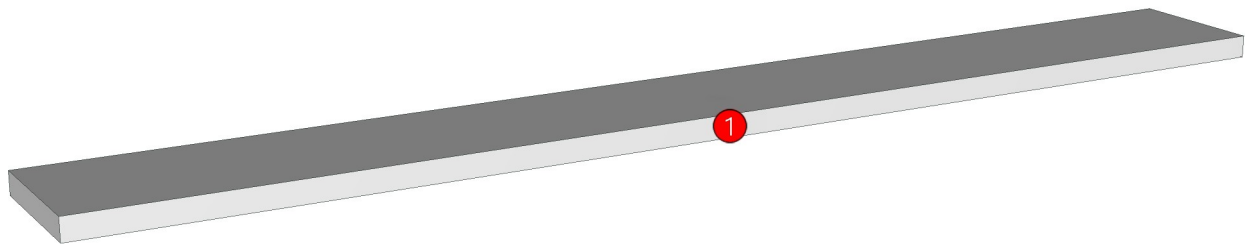
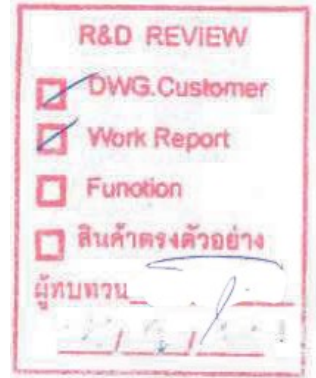

Model	ESCENT_UB2_DUT500		
Creator	PASATHORN	.BCP Name	INDEX_C3D_KITCHEN2
Reviewer		Order	I003197
Approves		Date	02/07/2024

No.	Article No.	Description	Mat	Dimension	Cutting Size	Typepology	Skin
0	ESCENT_UB2_DUT500 ESCENT_UB2_DUT500-01	ESCENT_UB2_DUT500 DUT-SP	PB-ST	500x9x60 9x60x500	9X58X500;L2:W0	182000 _STR=05.01 _EDG=WHITE-1	2

Model	ESCENT_UB2_D_FLR650S		
Creator	PASATHORN	.BCP Name	INDEX_C3D_KITCHEN2
Reviewer		Order	I003205
Approves		Date	02/07/2024

ESCENT_UB2_D_FLR650S-650X570X922

Colour

03.41 PVC T.0.13 MM.?? BEIGE MFI599_
05.41 ML FOSS ZILK# BK2 (CROSS METAL)_

-

-

K1L-160177280

K9L-160170770

K1R-160170715

K2L-160177289

K2R-160147377

Edge

01.319 1 MFI599 PEARL _
01.299 1 FOSS ZILK BK2 A1285 TH00 _

-

-

-

R&D REVIEW	
<input checked="" type="checkbox"/>	DWG.Customer
<input checked="" type="checkbox"/>	Work Report
<input type="checkbox"/>	Function
<input type="checkbox"/>	สินค้าตรงตัวอย่าง
ผู้ทบทวน _____	

K8R-160170757

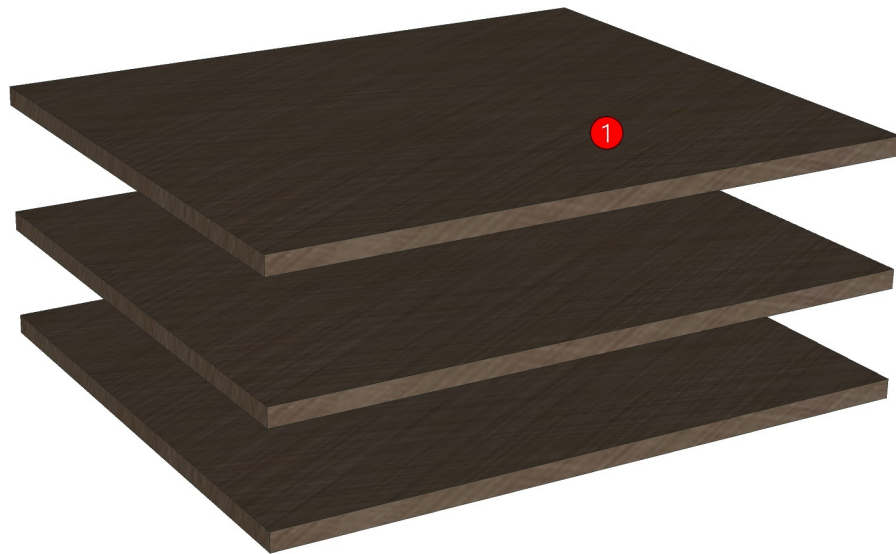

Model	-ESCENT_UB2_D_FLR650S		
Creator		.BCP Name	INDEX_C3D_KITCHEN2
Reviewer		Order	I003205
Approves		Date	

