

Model	CO_RM9_DBH602		
Creator	CHALEAMPHON	.BCP Name	INDEX_C3D_KITCHEN2
Reviewer		Order	H001647
Approves		Date	21/04/2025

CO_RM9_DBH602-600X570X808

Colour

20.39=ML WARM ROVERE AJ1 (WOOD VENEER)
20.44=ML WHITE VM1012/2610/2610 (PEAEL)
03.11=PVC 0.15 WHITE SAND #DFS7T06 (MALT)
06.01=TEXTURE DEAD STOCK

Edge

01.257=1 AJ1
01.47=1 WHITE



K1L-160159960
K1R-160159968
K7R-160159986
K9L-160159996
K10L-160160007
K11R-160160021
K12R-160160034
K13-160160046
K14L-160160062
K18L-160160095
K41L-160160107
K43R-160160120
K45L-160160128
K45R-160160136
K46L-160160144
K47L-160160154
K47R-160160164
K42R-160163061
K49R-160163076
K50L-160163093
K30L-160163598
K33R-160163623
K34L-160163640
K35R-160163664
K38L-160163700
K39L-160163713
K51L-160163751
K53R-160163774
K54L-160163786
K55R-160163795

K56R-160166129
K36R-160163675
K40R-160163724
K48R-160163741
K37R-160163688
K4R-160169343
K5L-160169355
K20L-160169365
K25L-160163437
K52R-160169499
K22L-160169388
K23L-160169398
K23R-160169411
K24R-160169424
K26R-160169450
K27L-160169466
K27R-160169478
K28L-160169490
K29L-160170467
K57R-160170479

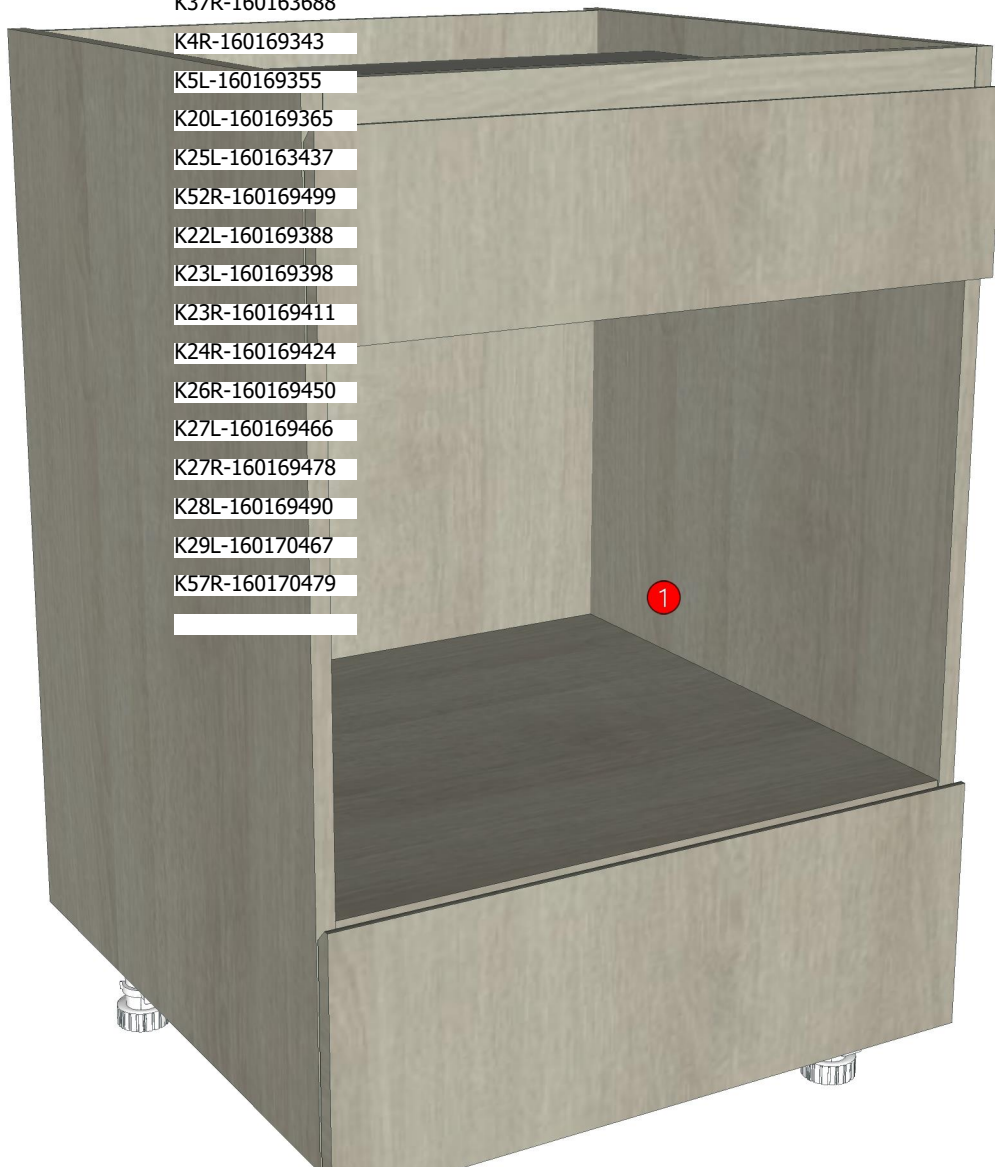

Model	-		
Creator	CHALEAMPHON	.BCP Name	INDEX_C3D_KITCHEN2
Reviewer		Order	H001647
Approves		Date	21/04/2025

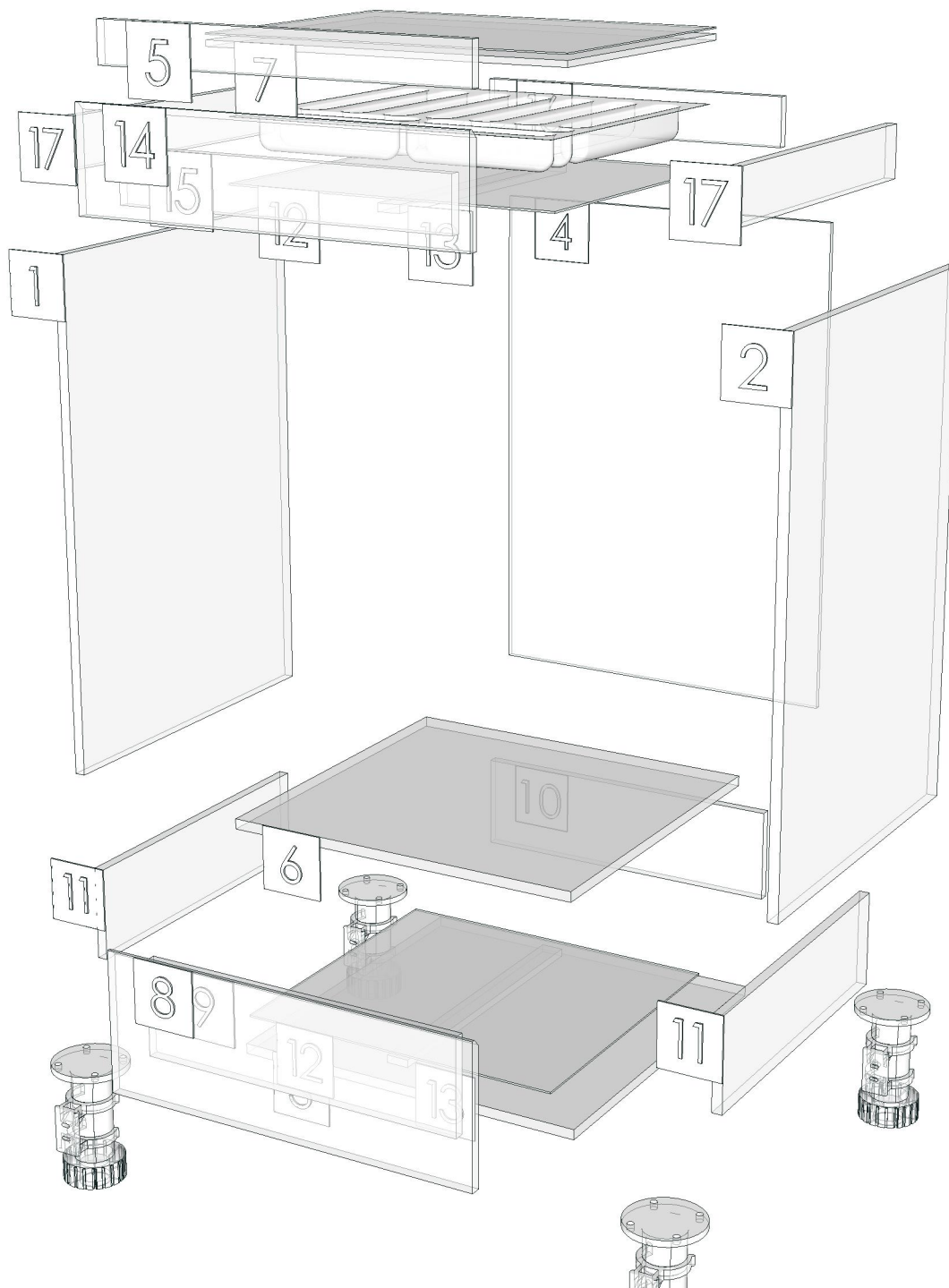

Model	CO_RM9_DBO19.5		
Creator	CHALEAMPHON	.BCP Name	INDEX_C3D_KITCHEN2
Reviewer		Order	H002014
Approves		Date	18/09/2025

CO_RM9_DBO19.5-195X570X808

Colour

20.39=ML WARM ROVERE AJ1 (WOOD VENEER)
20.44=ML WHITE VM1012/2610/2610 (PEAEL)
03.11=PVC 0.15 WHITE SAND #DFS7T06 (MALT)

Edge

01.257=1 AJ1
01.47=1 WHITE



K29L-160170467

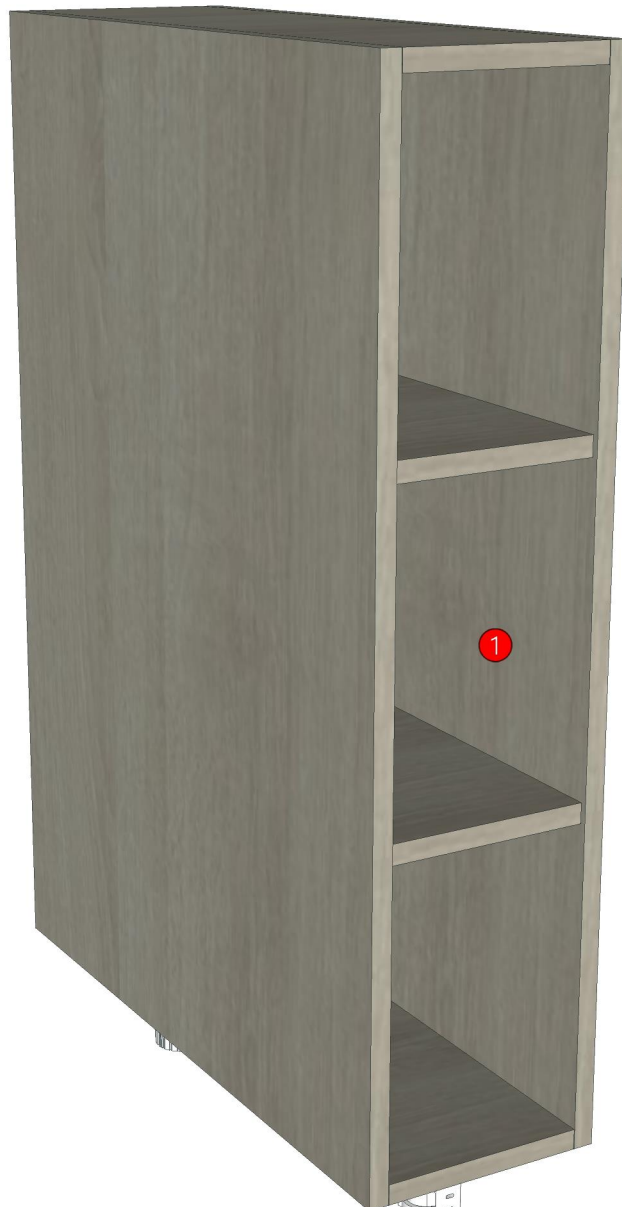

Model	-		
Creator	CHALEAMPON	.BCP Name	INDEX_C3D_KITCHEN2
Reviewer		Order	H002014
Approves		Date	18/09/2025

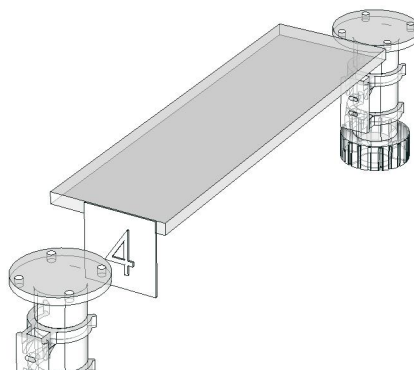
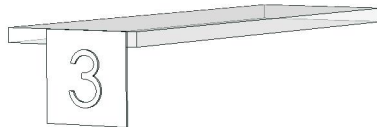

Model	CO_RM9_DBSC100_65R		
Creator	CHALEAMPHON	.BCP Name	INDEX_C3D_KITCHEN2
Reviewer		Order	H002015
Approves		Date	19/09/2025

CO_RM9_DBSC100_65R-1000X570X808

Colour

20.39=ML WARM ROVERE AJ1 (WOOD VENEER)
20.44=ML WHITE VM1012/2610/2610 (PEAEL)
03.11=PVC 0.15 WHITE SAND #DFS7T06 (MALT)

Edge

01.257=1 AJ1
01.47=1 WHITE

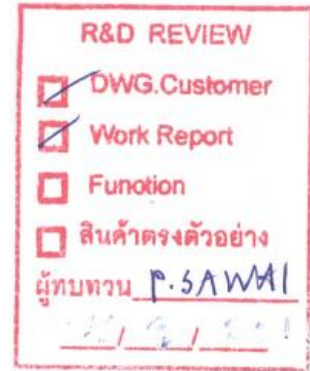

K29L-160170467



Model	-		
Creator	CHALEAMPHON	.BCP Name	INDEX_C3D_KITCHEN2
Reviewer		Order	H002015
Approves		Date	19/09/2025

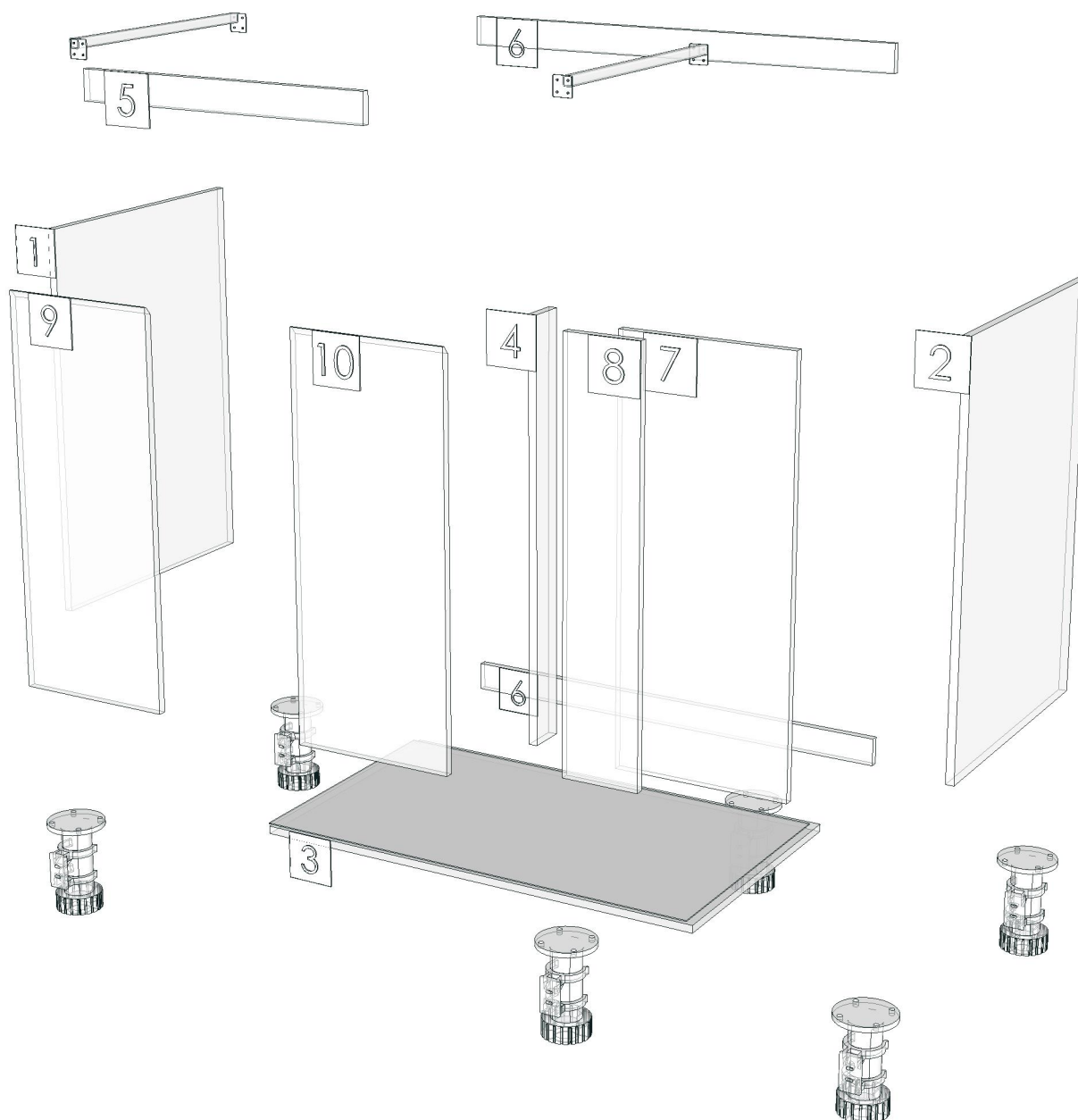

Model	CO_RM9_DFB		
Creator	CHALEAMPHON	.BCP Name	INDEX_C3D_KITCHEN2
Reviewer		Order	H001591
Approves		Date	06/03/2025

CO_RM9_DFB-150X570X808

Colour

20.39=ML WARM ROVERE AJ1 (WOOD VENEER)

Edge

01.257=1 AJ1



- K2R-160159976
- K9L-160159996
- K10L-160160007
- K11R-160160021
- K16R-160160085
- K18L-160160095
- K41L-160160107
- K42R-160163061
- K49R-160163076
- K50L-160163093
- K30L-160163598
- K33R-160163623
- K34L-160163640
- K38L-160163700
- K51L-160163751
- K54L-160163786
- K56R-160166129
- K55R-160163795
- K36R-160163675
- K40R-160163724
- K4R-1601569343
- K20L-160169365
- K26R-160169450
- K28L-160169490
- K29L-160170467

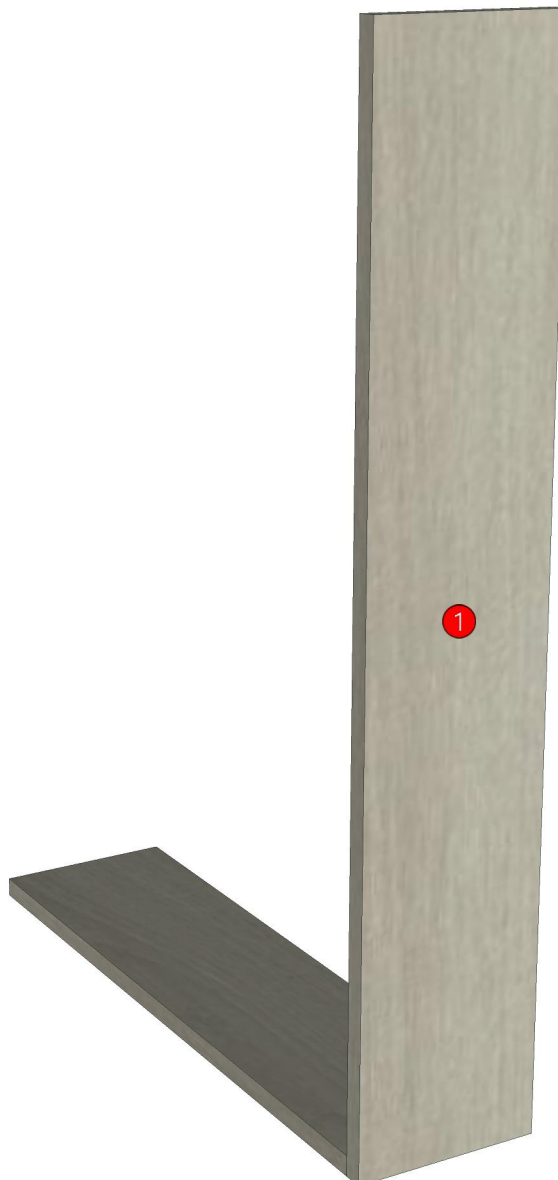

Model	-CO RM9		
Creator	CHALEAMPON	.BCP Name	INDEX_C3D_KITCHEN2
Reviewer		Order	H001591
Approves		Date	06/03/2025

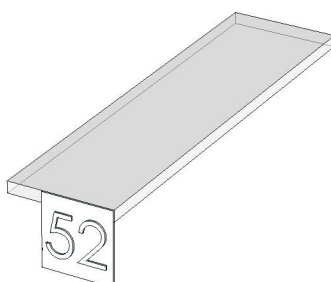
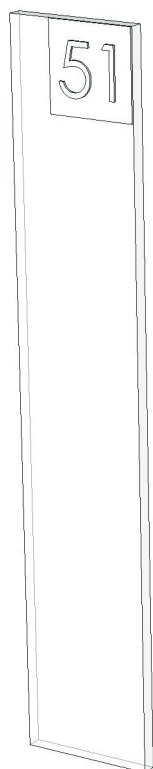

Model	CO_RM9_DFCL_1200		
Creator	CHALEAMPON	.BCP Name	INDEX_C3D_KITCHEN2
Reviewer		Order	H001835
Approves		Date	02/07/2025

CO_RM9_DFCL_1200-1200X9X130

Colour

05.96=ML.WHITE NORDIC ELM BS9 (MATT WOODGRAIN)

Edge

01.366=1 BS9



K49R-160163076
K50L-160163093
K33R-160163623
K29L-160170467

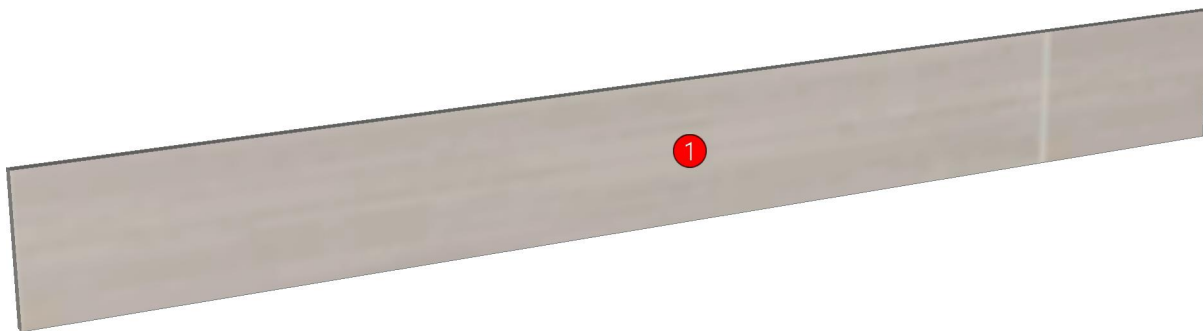

Model	CO_RM9_DFCL_1200		
Creator	CHALEAMPHON	.BCP Name	INDEX_C3D_KITCHEN2
Reviewer		Order	H001835
Approves		Date	02/07/2025

No.	Article No.	Description	Mat	Dimension	Cutting Size	Typepology	Skin
0	CO_RM9_DFCL_1200			1200x130x9			
	CO_RM9_DFCL_1200-01	FILLER TOP	PB-ST	9x130x1200	9X129X1199;L1:W1	183000_STR=05.96_EDG=BS9-1	2

Model	CO_RM9_DFCL_1900		
Creator	CHALEAMPON	.BCP Name	INDEX_C3D_KITCHEN2
Reviewer		Order	H001761
Approves		Date	27/05/2025

CO_RM9_DFCL_1900-1900X9X130

Colour

05.96=ML.WHITE NORDIC ELM BS9 (MATT WOODGRAIN)

Edge

01.366=1 BS9



K16R-160160085

K53R-160163774

K29L-160170467

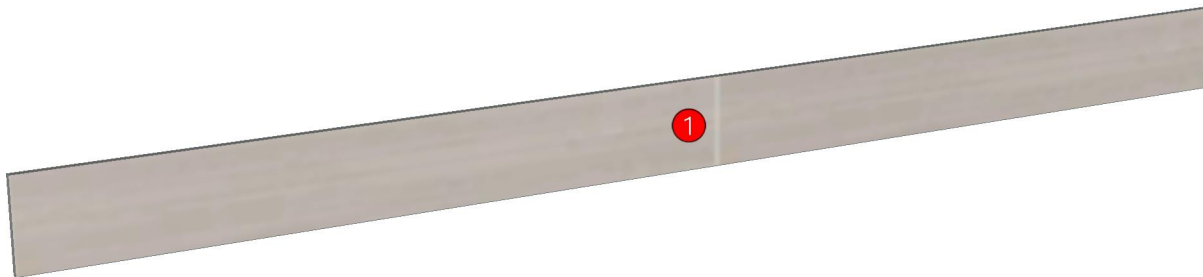

Model	CO_RM9_DFCL_1900		
Creator	CHALEAMPON	.BCP Name	INDEX_C3D_KITCHEN2
Reviewer		Order	H001761
Approves		Date	27/05/2025

No.	Article No.	Description	Mat	Dimension	Cutting Size	Typepology	Skin
0	CO_RM9_DFCL_1900			1900x130x9			
	CO_RM9_DFCL_1900-02	FILLER TOP	PB-ST	9x130x1900	9X129X1898;L1:W2	183000_STR=05.96_EDG=BS9-1	2

Model	CO_RM9_DFCL_300		
Creator	CHALEAMPHON	.BCP Name	INDEX_C3D_KITCHEN2
Reviewer		Order	H001597
Approves		Date	06/03/2025

CO_RM9_DFCL_300-300X9X130

Colour

05.96=ML.WHITE NORDIC ELM BS9 (MATT WOODGRAIN)

Edge

01.366=1 BS9



- K1L-160159960
- K1R-160159968
- K9L-160159996
- K13L-160160046
- K18L-160160095
- K41L-160160107
- K43R-160160120
- K45L-160160128
- K45R-160160136
- K42R-160163061
- K49R-160163076
- K50L-160163093
- K30L-160163598
- K33R-160163623
- K34L-160163640
- K38L-160163700
- K51L-160163751
- K53R-160163774
- K54L-160163786
- K56R-160166129
- K55R-160163795
- K36R-160163675
- K40R-160163724
- K48R-160163741
- K5L-160169355
- K20L-160169365
- K52R-160169499
- K29L-160170467

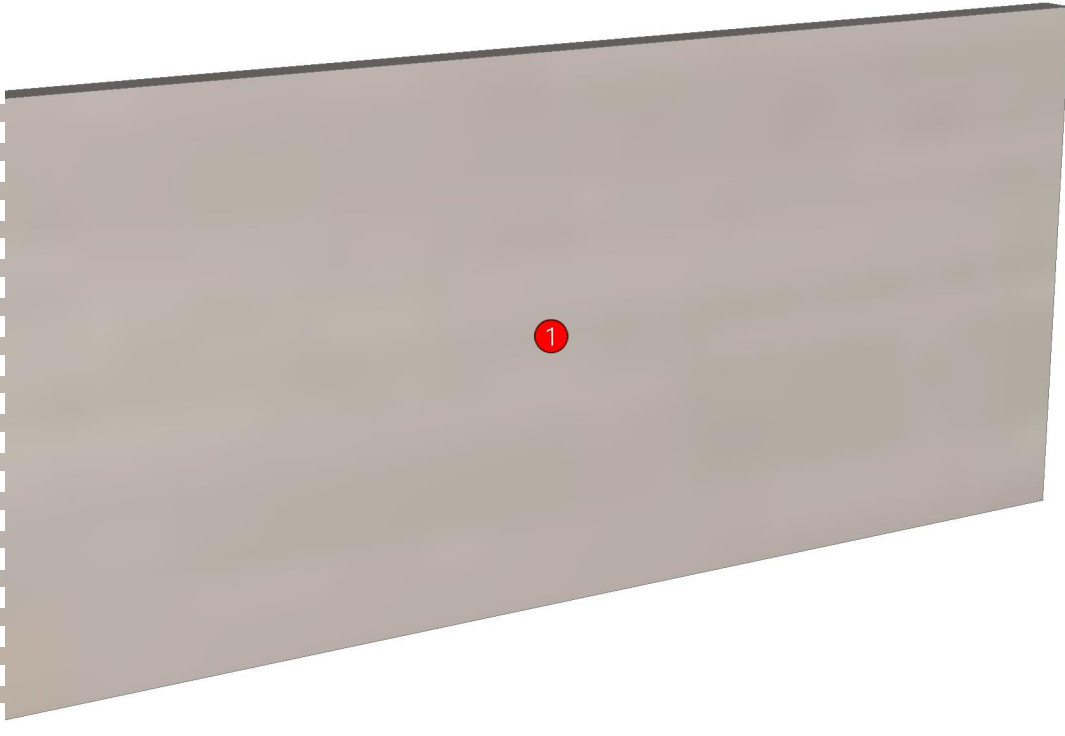

Model	CO_RM9_DFCL_300		
Creator	CHALEAMPON	.BCP Name	INDEX_C3D_KITCHEN2
Reviewer		Order	H001597
Approves		Date	06/03/2025

No.	Article No.	Description	Mat	Dimension	Cutting Size	Typepology	Skin
0	CO_RM9_DFCL_300 CO_RM9_DFCL_300-01	FILLER TOP	PB-ST	300x130x9 9x130x300	9X129X299;L1:W1	183000_STR=05.96_EDG=BS9-1	2

Model	CO_RM9_DFL		
Creator	CHALEAMPHON	.BCP Name	INDEX_C3D_KITCHEN2
Reviewer		Order	H001657
Approves		Date	25/04/2025

CO_RM9_DFL-150X300X700

Colour

05.96=ML.WHITE NORDIC ELM BS9 (MATT WOODGRAIN)

Edge

01.366=1 BS9

R&D REVIEW	
<input checked="" type="checkbox"/>	DWG.Customer
<input checked="" type="checkbox"/>	Work Report
<input type="checkbox"/>	Function
<input type="checkbox"/>	สินค้าตรงตัวอย่าง
ผู้ทบทวน <u>P.SAWAI</u>	
<u>25/04/25</u>	

K9L-160159996
K18L-160160095
K41L-160160107
K42R-160163061
K49R-160163076
K50L-160163093
K30L-160163598
K33R-160163623
K34L-160163640
K38L-160163700
K39L-160163713
K51L-160163751
K54L-160163786
K56R-160166129
K55R-160163795
K36R-160163675
K40R-160163724
K37R-160163688
K4R-160169343
K20L-160169365
K28L-160169490
K29L-160170467



Model	-CO RM9		
Creator	CHALEAMPON	.BCP Name	INDEX_C3D_KITCHEN2
Reviewer		Order	H001657
Approves		Date	25/04/2025

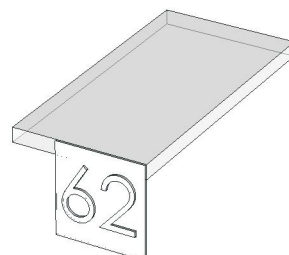
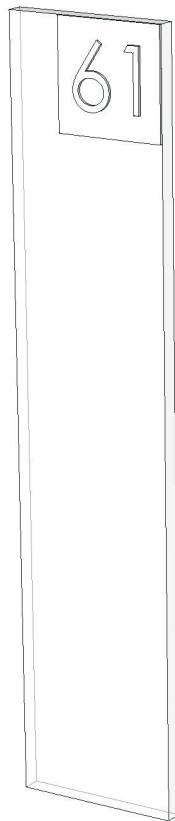
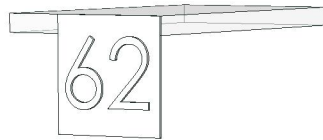

Model	CO_RM9_DL35R		
Creator	CHALEAMPHON	.BCP Name	INDEX_C3D_KITCHEN2
Reviewer		Order	H001673
Approves		Date	06/05/2025

CO_RM9_DL35R-350X300X700

Colour

05.96=ML.WHITE NORDIC ELM BS9 (MATT WOODGRAIN)

20.44=ML WHITE VM1012/2610/2610 (PEAEL)

03.11=PVC 0.15 WHITE SAND #DFS7T06 (MALT)

Edge

01.366=1 BS9

01.47=1 WHITE

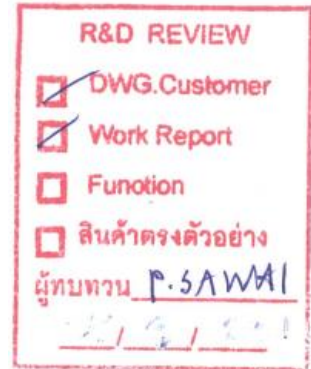

K37R-160163688

K29L-160170467

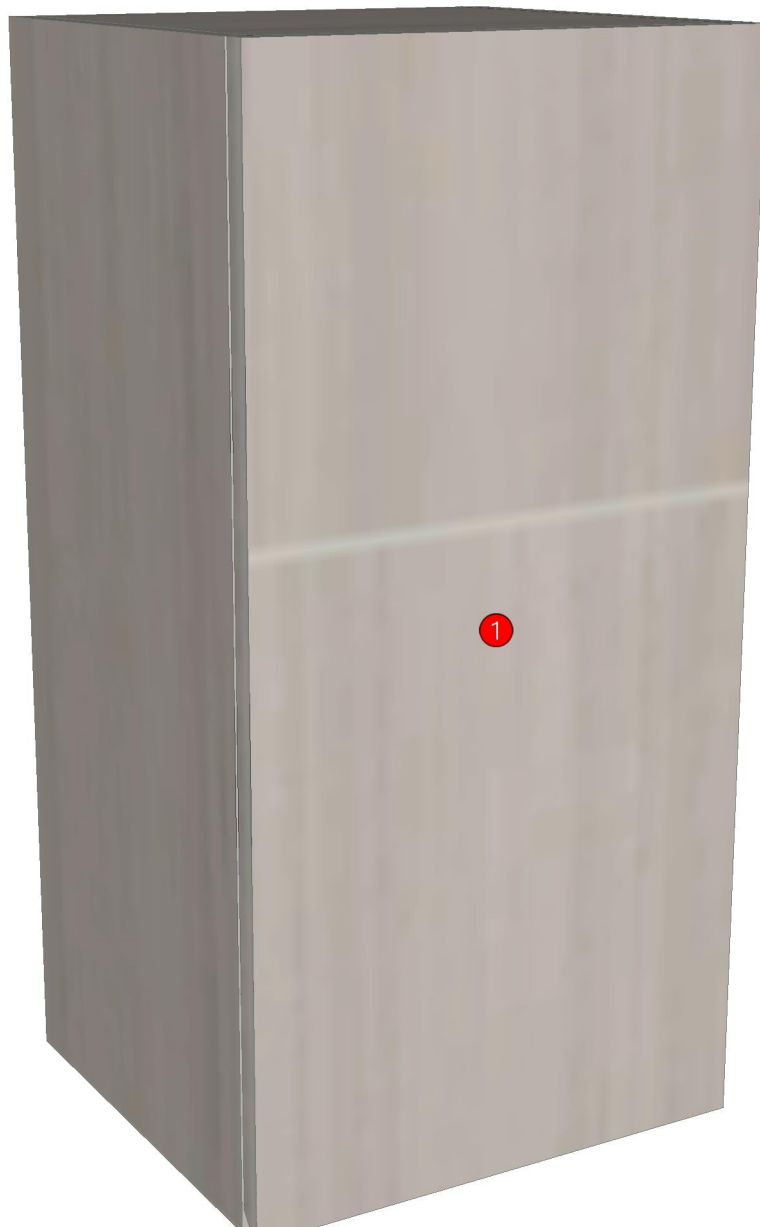

Model	-CO RM9		
Creator	CHALEAMPHON	.BCP Name	INDEX_C3D_KITCHEN2
Reviewer		Order	H001673
Approves		Date	06/05/2025

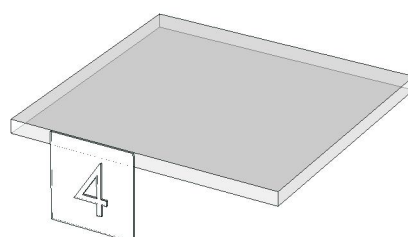
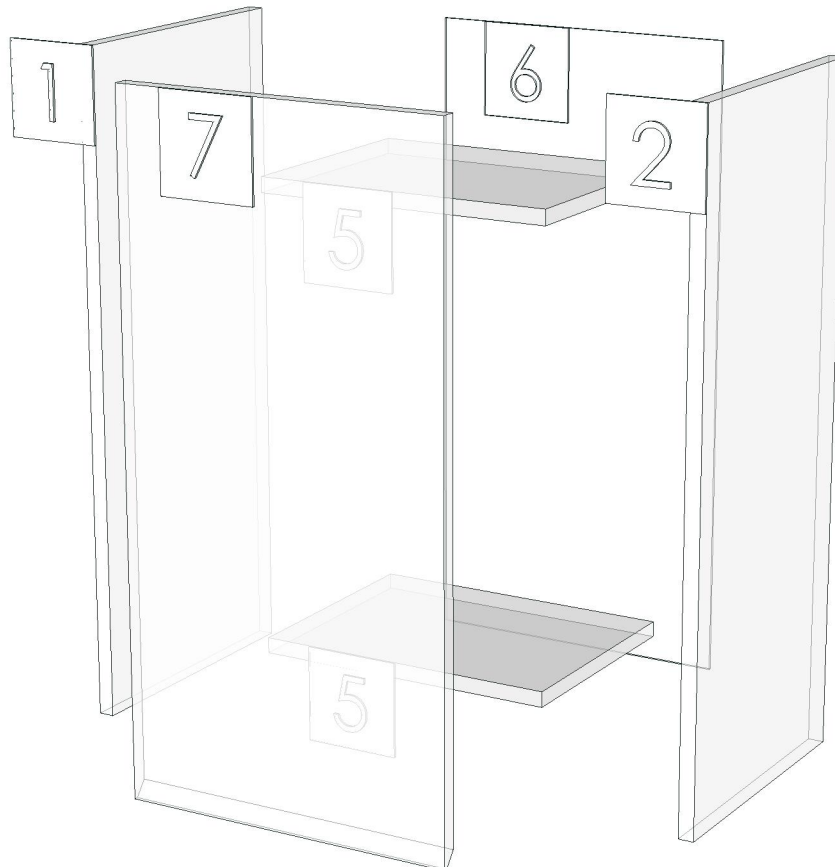

Model	CO_RM9_DL60(C)L		
Creator	CHALEAMPHON	.BCP Name	INDEX_C3D_KITCHEN2
Reviewer		Order	H001693
Approves		Date	08/05/2025

CO_RM9_DL60(C)L-600X300X700

Colour

05.96=ML.WHITE NORDIC ELM BS9 (MATT WOODGRAIN)

20.44=ML WHITE VM1012/2610/2610 (PEAEL)

03.11=PVC 0.15 WHITE SAND #DFS7T06 (MALT)

Edge

01.366=1 BS9

01.47=1 WHITE



K9L-160159996

K39L-160163713

K29L-160170467



Model	-CO RM9		
Creator	CHALEAMPHON	.BCP Name	INDEX_C3D_KITCHEN2
Reviewer		Order	H001693
Approves		Date	08/05/2025

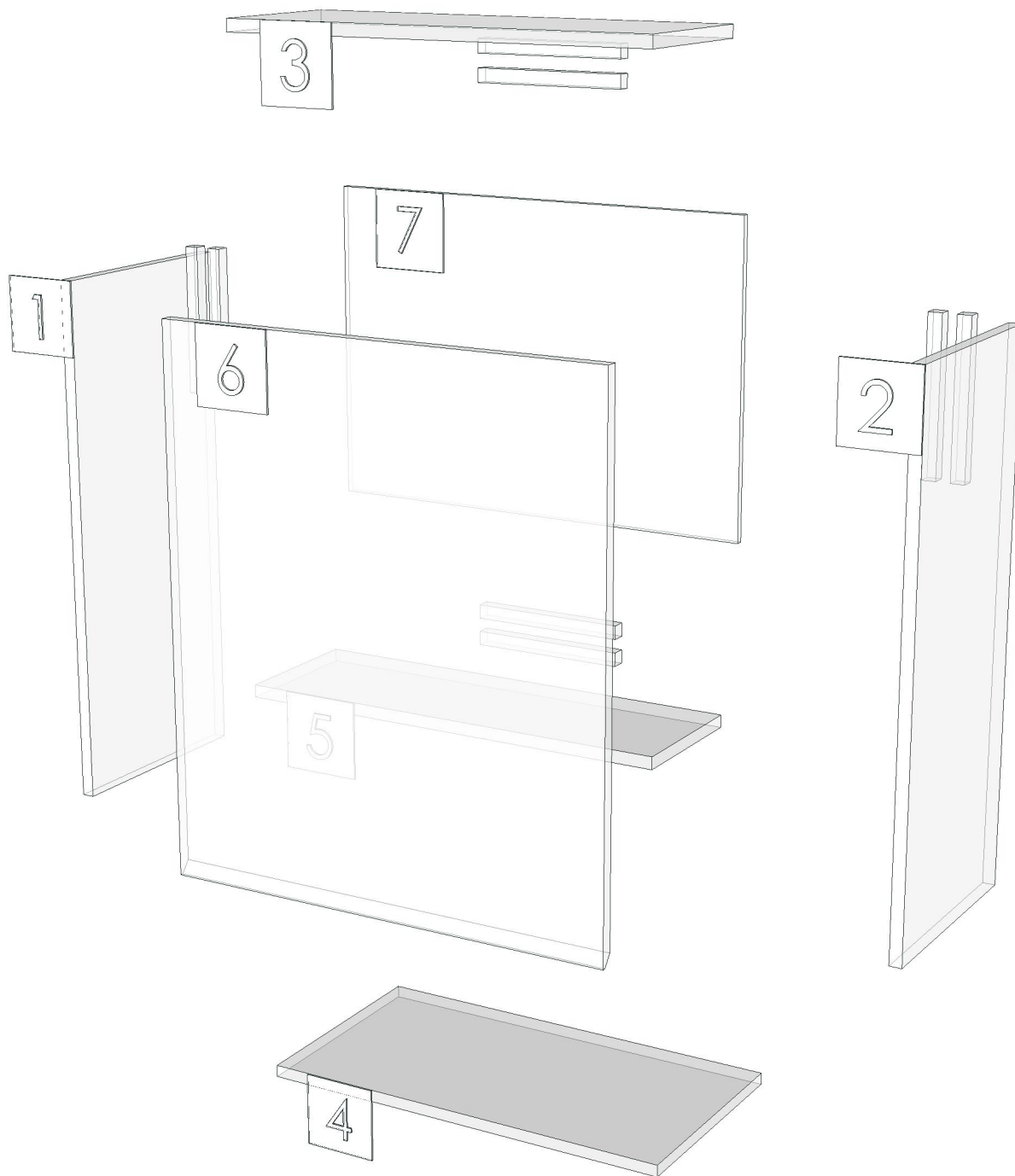

Model	CO_RM9_DL60HR		
Creator	CHALEAMPHON	.BCP Name	INDEX_C3D_KITCHEN2
Reviewer		Order	H001588
Approves		Date	05/03/2025

CO_RM9_DL60HR-600X300X660

Colour

05.96=ML.WHITE NORDIC ELM BS9 (MATT WOODGRAIN)

20.44=ML WHITE VM1012/2610/2610 (PEAEL)

03.11=PVC 0.15 WHITE SAND #DFS7T06 (MALT)

Edge

01.366=1 BS9

01.47=1 WHITE

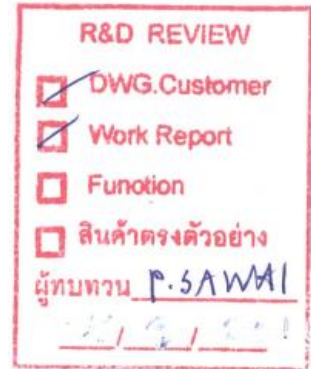

K1L-160159960

K9L-160159996

K10L-160160007

K13L-160160046

K14L-160160062

K15L-160160073

K45L-160160128

K46L-160160144

K47L-160160154

K38L-160163700

K39L-160163713

K54L-160163786

K5L-160169355

K25L-160169437

K23L-160169398

K27L-160169466

K28L-160169490

K29L-160170467



Model	-CO RM9		
Creator	CHALEAMPON	.BCP Name	INDEX_C3D_KITCHEN2
Reviewer		Order	H001588
Approves		Date	05/03/2025

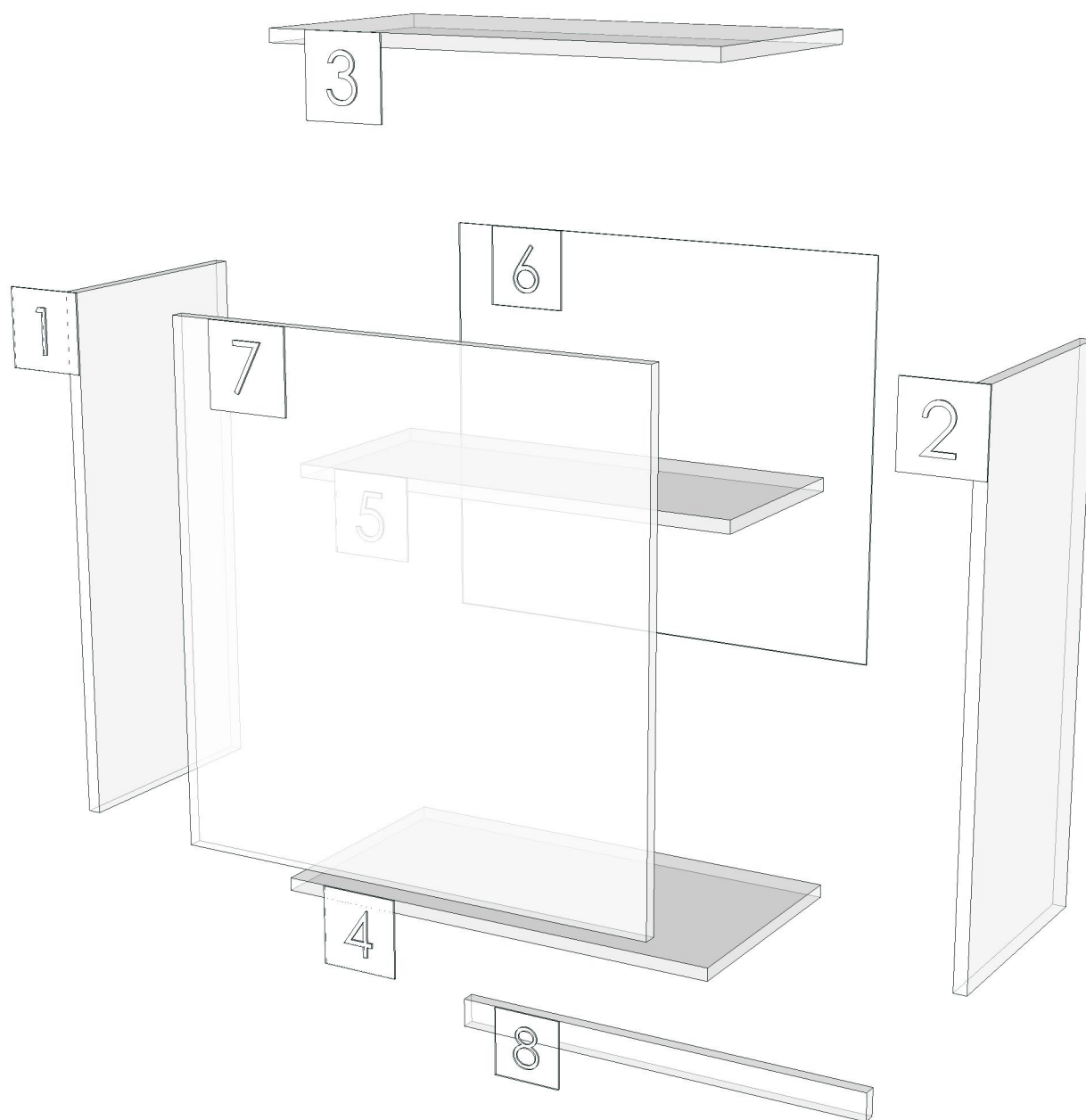

Model	CO_RM9_DLC60_45L		
Creator	CHALEAMPHON	.BCP Name	INDEX_C3D_KITCHEN2
Reviewer		Order	H002016
Approves		Date	19/09/2025

CO_RM9_DLC60_45L-600X300X700

Colour

05.96=ML.WHITE NORDIC ELM BS9 (MATT WOODGRAIN)

20.44=ML WHITE VM1012/2610/2610 (PEAEL)

03.11=PVC 0.15 WHITE SAND #DFS7T06 (MALT)

Edge

01.366=1 BS9

01.47=1 WHITE

R&D REVIEW	
<input checked="" type="checkbox"/>	DWG.Customer
<input checked="" type="checkbox"/>	Work Report
<input type="checkbox"/>	Function
<input type="checkbox"/>	สินค้าตรงตัวอย่าง
ผู้ทบทวน <u>P.SAWAI</u>	
<u>22/9/25</u>	

K29L-160170467

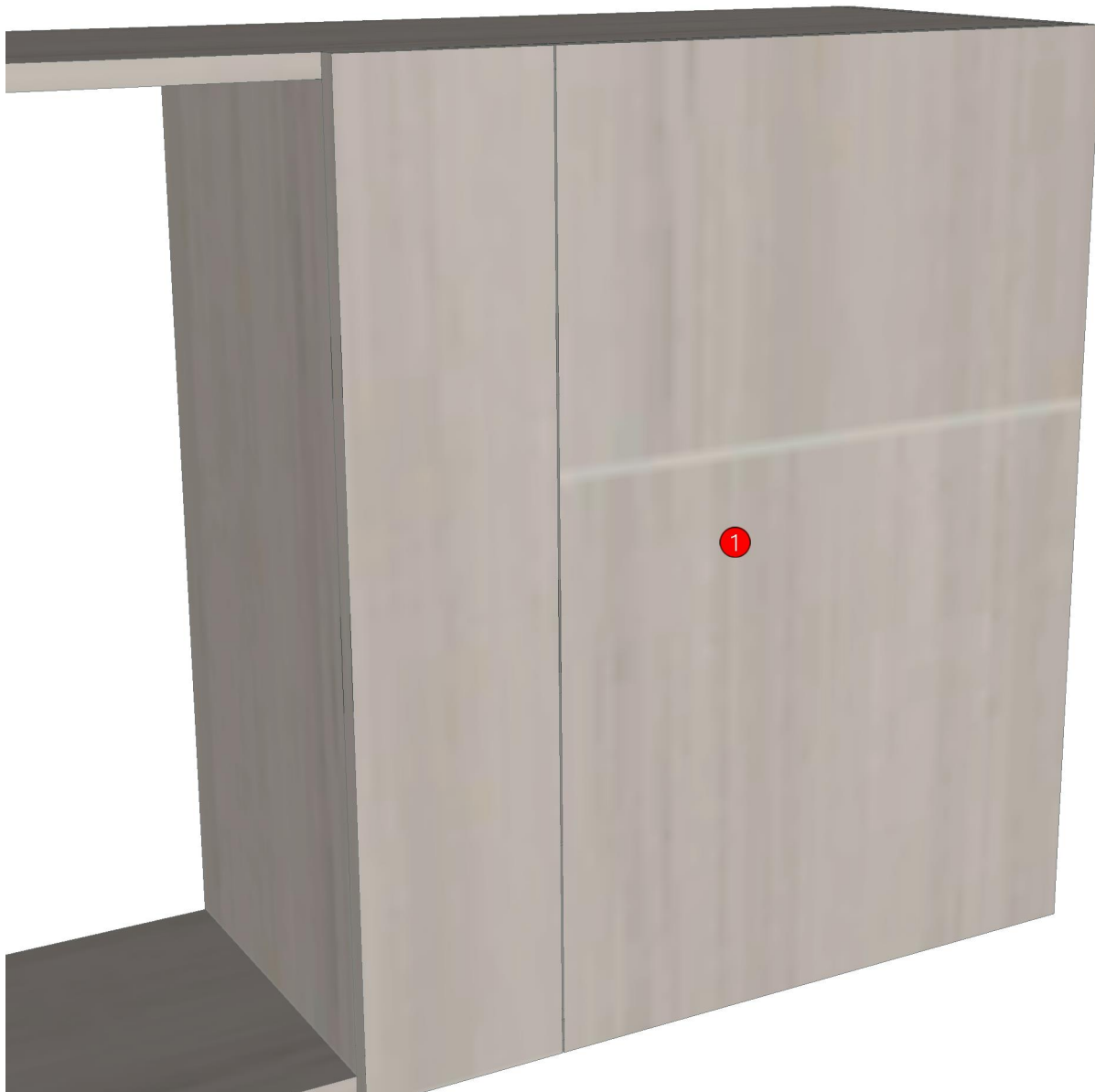

Model	-		
Creator	CHALEAMPON	.BCP Name	INDEX_C3D_KITCHEN2
Reviewer		Order	H002016
Approves		Date	19/09/2025

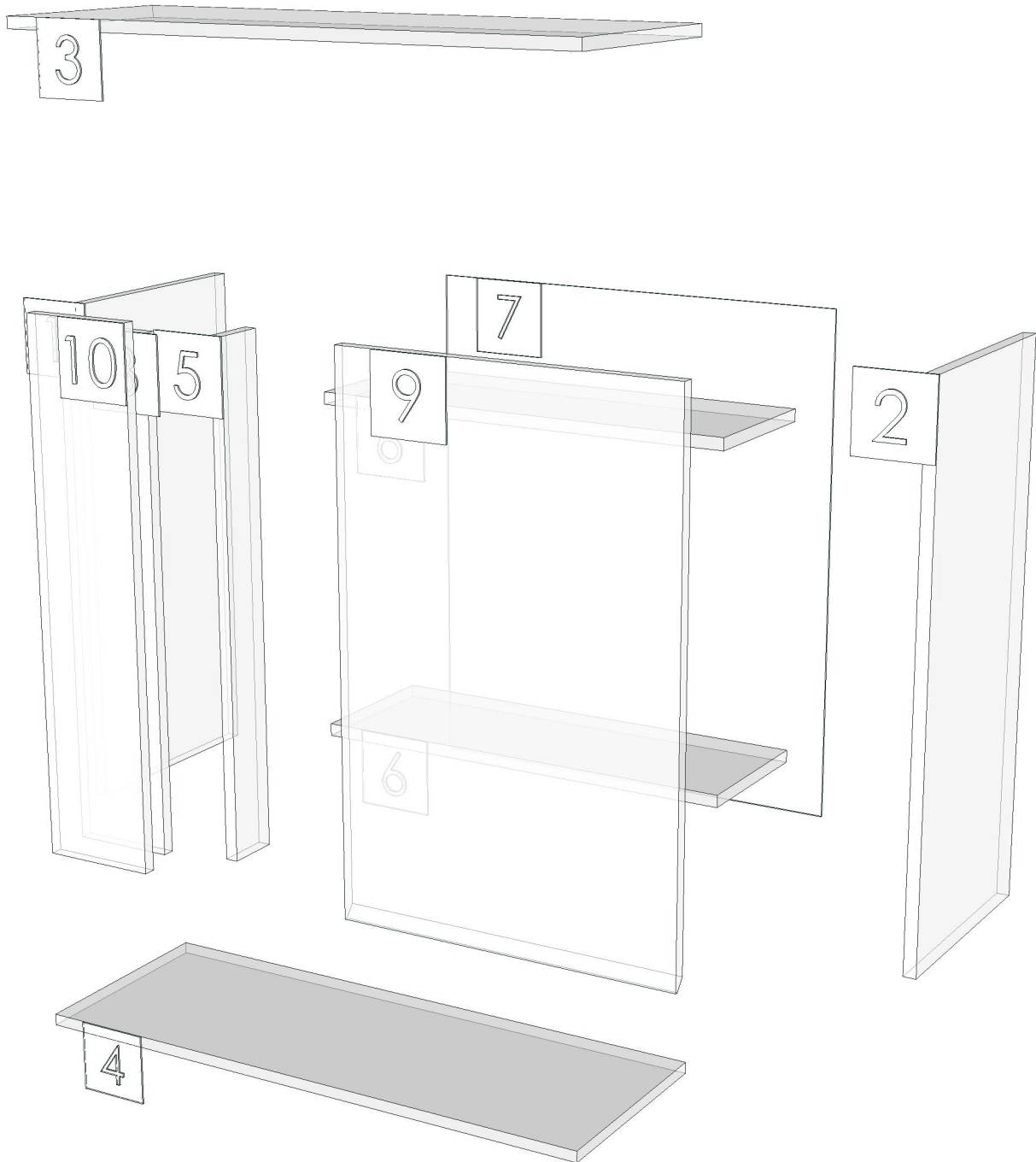

Model	CO_RM9_DPLT_600		
Creator	CHALEAMPHON	.BCP Name	INDEX_C3D_KITCHEN2
Reviewer		Order	H001601
Approves		Date	06/03/2025

CO_RM9_DPLT_600-600X9X100

Colour

20.39=ML WARM ROVERE AJ1 (WOOD VENEER)

Edge

01.257=1 AJ1



- | | |
|----------------|----------------|
| K1L-160159960 | K54L-160163786 |
| K1R-160159968 | K56R-160166129 |
| K2R-160159976 | K55R-160163795 |
| K7R-160159986 | K36R-160163675 |
| K9L-160159996 | K40R-160163724 |
| K10L-160160007 | K48R-160163741 |
| K11R-160160021 | K37R-160163688 |
| K12R-160160034 | K4R-160169343 |
| K14L-160160062 | K5L-160169355 |
| K15L-160160073 | K20L-160169365 |
| K16R-160160085 | K25L-160169437 |
| K18L-160160095 | K52R-160169499 |
| K41L-160160107 | K22L-160169388 |
| K43R-160160120 | K23L-160169398 |
| K45L-160160128 | K23R-160169411 |
| K45R-160160136 | K24R-160169424 |
| K46L-160160144 | K26R-160169450 |
| K47L-160160154 | K27L-160169466 |
| K47R-160160164 | K27R-160169478 |
| K42R-160163061 | K28L-160169490 |
| K49R-160163076 | K29L-160170467 |
| K50L-160163093 | K57R-160170479 |
| K30L-160163598 | |
| K33R-160163623 | |
| K34L-160163640 | |
| K35R-160163664 | |
| K38L-160163700 | |
| K39L-160163713 | |
| K51L-160163751 | |
| K53R-160163774 | |

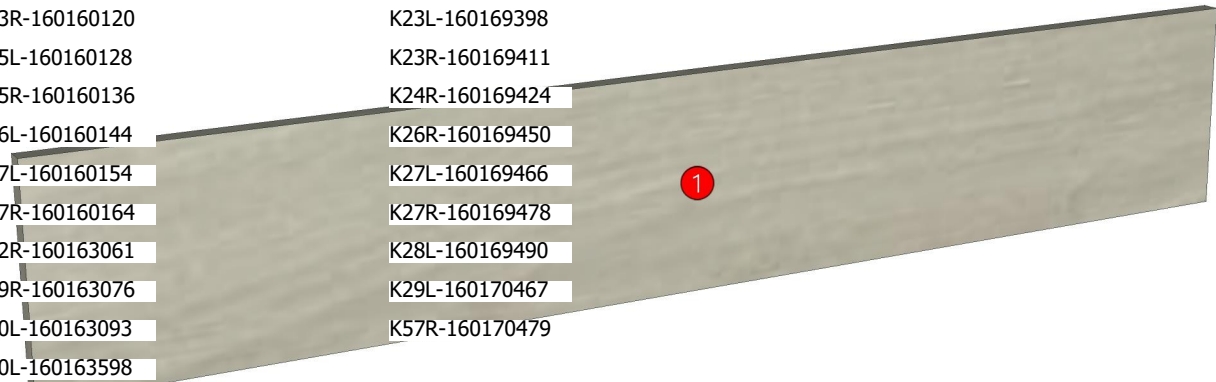

Model	CO_RM9_DPLT_600		
Creator	CHALEAMPON	.BCP Name	INDEX_C3D_KITCHEN2
Reviewer		Order	H001601
Approves		Date	06/03/2025

No.	Article No.	Description	Mat	Dimension	Cutting Size	Typepology	Skin
0	CO_RM9_DPLT_600			600x100x9			
	CO_RM9_DPLT_600-01	LED BOTTOM	PB-ST	9x100x600	9X98X598;L2:W2	183000_STR=20.39_EDG=AJ1-1	2

Model	CO_RM9_DPLT_800		
Creator	CHALEAMPON	.BCP Name	INDEX_C3D_KITCHEN2
Reviewer		Order	H001779
Approves		Date	29/05/2025

CO_RM9_DPLT_800-800X9X100

Colour

20.39=ML WARM ROVERE AJ1 (WOOD VENEER)

Edge

01.257=1 AJ1



K41L-160160107

K38L-160163700

K29L-160170467

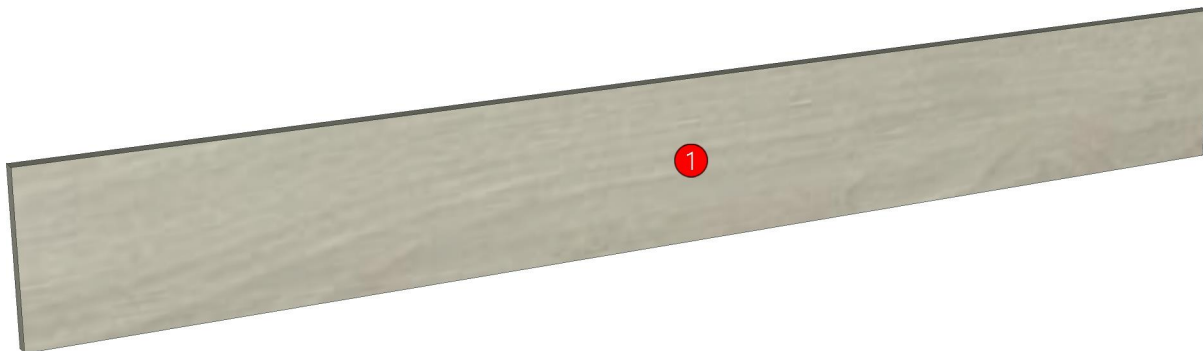

Model	CO_RM9_DPLT_800		
Creator	CHALEAMPON	.BCP Name	INDEX_C3D_KITCHEN2
Reviewer		Order	H001779
Approves		Date	29/05/2025

No.	Article No.	Description	Mat	Dimension	Cutting Size	Typepology	Skin
0	CO_RM9_DPLT_800			800x100x9			
	CO_RM9_DPLT_800-02	LED BOTTOM	PB-ST	9x100x800	9X98X799;L2:W1	183000_STR=20.39_EDG=AJ1-1	2

Model	CO_RM9_DPLT_900		
Creator	CHALEAMPON	.BCP Name	INDEX_C3D_KITCHEN2
Reviewer		Order	H001780
Approves		Date	29/05/2025

CO_RM9_DPLT_900-900X9X100

Colour

20.39=ML WARM ROVERE AJ1 (WOOD VENEER)

Edge

01.257=1 AJ1



K9L-160159996

K30L-160163598

K34L-160163640

K29L-160170467

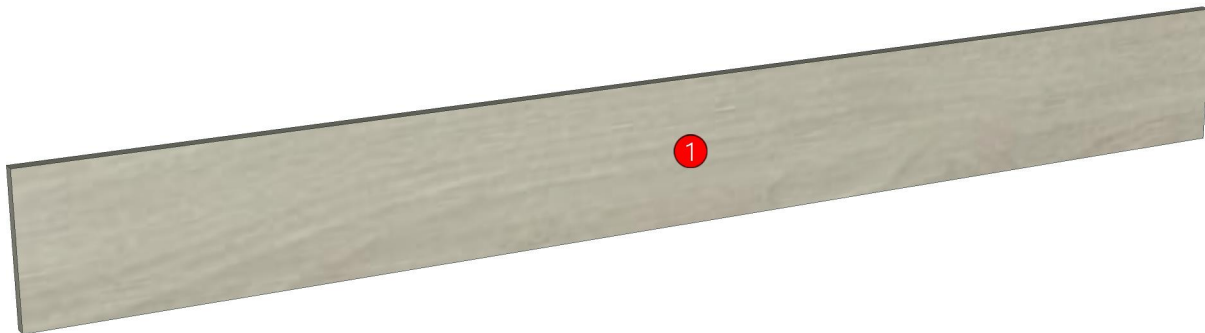

Model	CO_RM9_DPLT_900		
Creator	CHALEAMPON	.BCP Name	INDEX_C3D_KITCHEN2
Reviewer		Order	H001780
Approves		Date	29/05/2025

No.	Article No.	Description	Mat	Dimension	Cutting Size	Typepology	Skin
0	CO_RM9_DPLT_900			900x100x9			
	CO_RM9_DPLT_900-01	LED BOTTOM	PB-ST	9x100x900	9X98X898;L2:W2	183000_STR=20.39_EDG=AJ1-1	2

Model	CO_RM9_DW70		
Creator	CHALEAMPHON	.BCP Name	INDEX_C3D_KITCHEN2
Reviewer		Order	H001662
Approves		Date	28/04/2025

CO_RM9_DW70-700X300X400

Colour

05.96=ML.WHITE NORDIC ELM BS9 (MATT WOODGRAIN)

20.24=ML AE9V (PEARL)

03.11=PVC 0.15 WHITE SAND #DFS7T06 (MALT)

Edge

01.366=1 BS9

01.47=1 WHITE



- K10L-160160007
- K11R-160160021
- K12R-160160034
- K41L-160160107
- K43R-160160120
- K42R-160163061
- K33R-160163623
- K35R-160163664
- K39L-160163713
- K54L-160163786
- K36R-160163675
- K4R-160169343
- K26R-160169450
- K27L-160169466
- K27R-160169478
- K29L-160170467

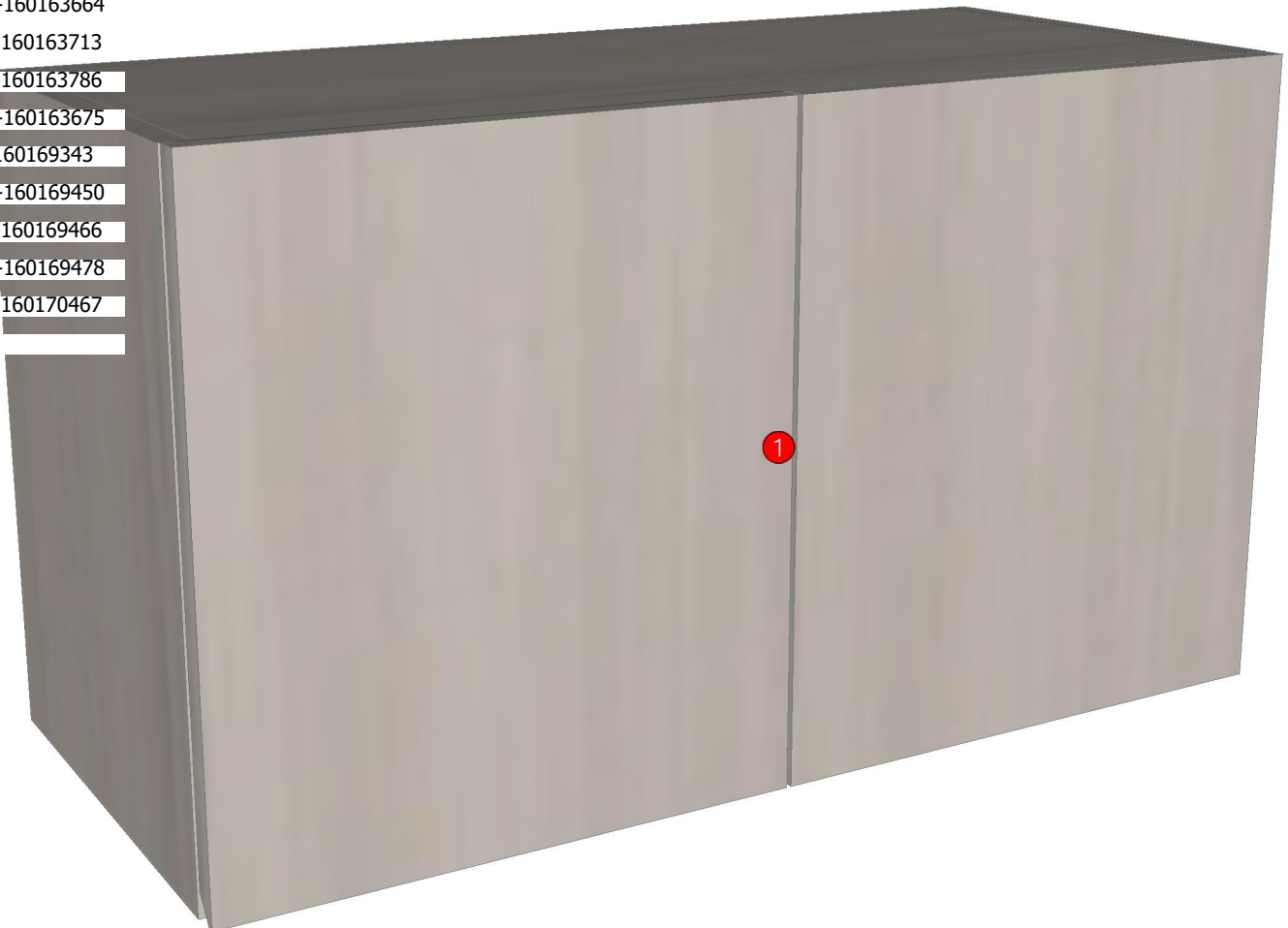

Model	-CO RM9		
Creator	CHALEAMPON	.BCP Name	INDEX_C3D_KITCHEN2
Reviewer		Order	H001662
Approves		Date	28/04/2025

