

Model	ESCENT_PK2_DB301R		
Creator	PASATHORN	.BCP Name	INDEX_C3D_KITCHEN2
Reviewer		Order	I004546
Approves	P. SAWAI	Date	20/10/2025

ESCENT_PK2_DB301R-300X570X922

Colour

05.30 ML WHITE SAND #VM1012/2610/2610(PEARL)_

05.79 ML.NATURAL ASH (VM20682/2097/2097)_

-
-
-

Edge

01.47 1 WHITE _

01.421 1 NATURAL ASH (DA56-11001-M0) _

-
-
-

R&D REVIEW

DWG.Customer

Work Report

Function

สินค้าคงตัวอย่าง

ผู้ทบทวน P. SAWAI

29 / 10 / 68

K3R-160170395

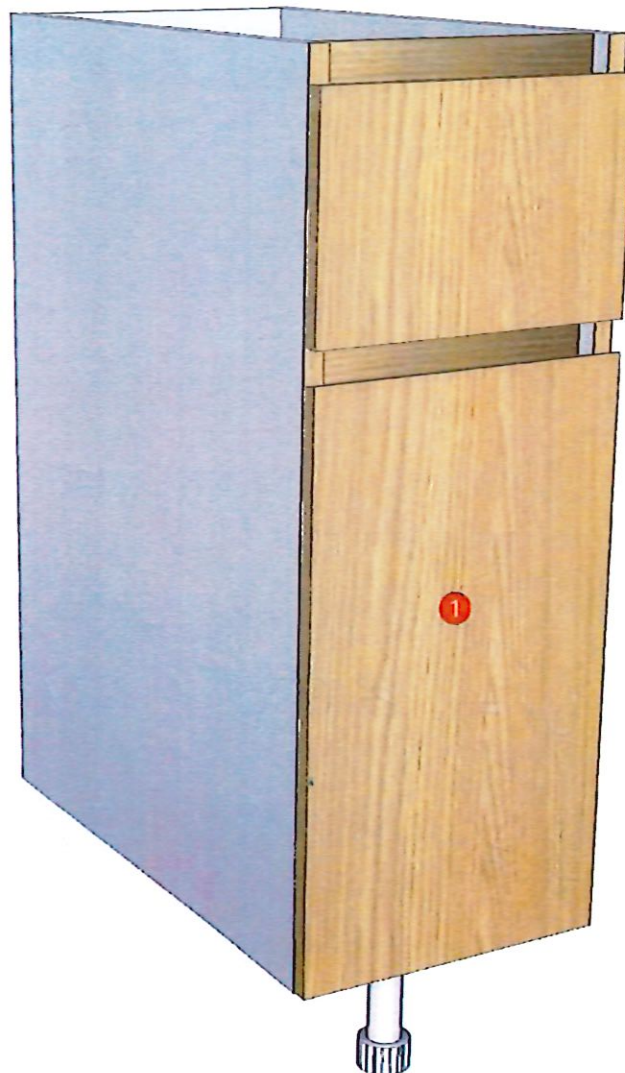

Model	-ESCENT_PK2_DB301R		
Creator		.BCP Name	INDEX_C3D_KITCHEN2
Reviewer		Order	I004546
Approves	P. SAWAI	Date	

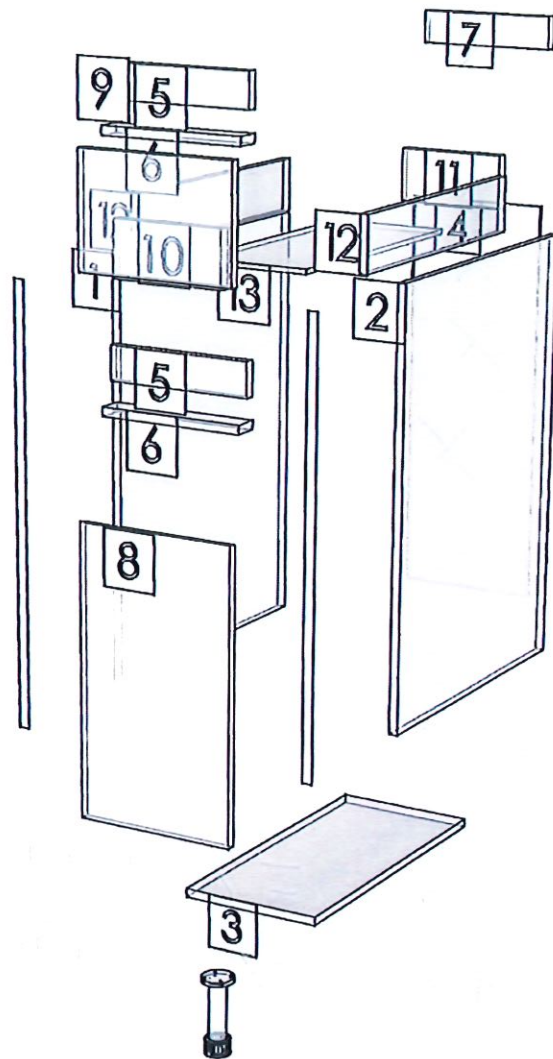

Model	ESCENT_PK2_DBSC7050LS		
Creator	PASATHORN	.BCP Name	INDEX_C3D_KITCHEN2
Reviewer		Order	I004552
Approves	P.SAWA	Date	21/10/2025

ESCENT_PK2_DBSC7050LS-700X570X922

Colour

05.30 ML WHITE SAND #VM1012/2610/2610(PEARL)_

05.79 ML.NATURAL ASH (VM20682/2097/2097)_

-
-
-

Edge

01.47 1 WHITE _

01.421 1 NATURAL ASH (DA56-11001-M0) _

-
-
-

R&D REVIEW

DWG.Customer

Work Report

Function

สินค้าคงตัวอย่าง

ผู้ทบทวน P. SAWA

29 / 10 / 2025

K3R-160170395

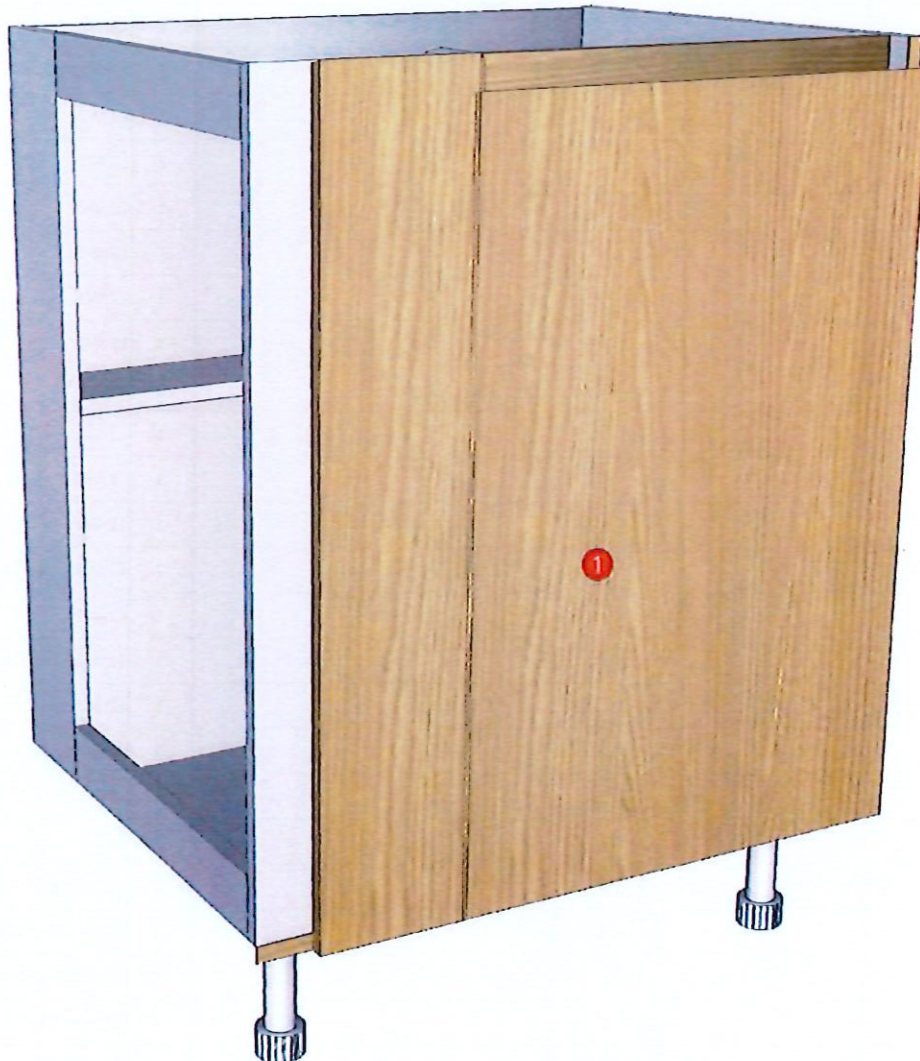

Model	-ESCENT_PK2_DBSC7050LS			
Creator		.BCP Name	INDEX_C3D_KITCHEN2	
Reviewer		Order	I004552	
Approves	P. SAMMI		Date	

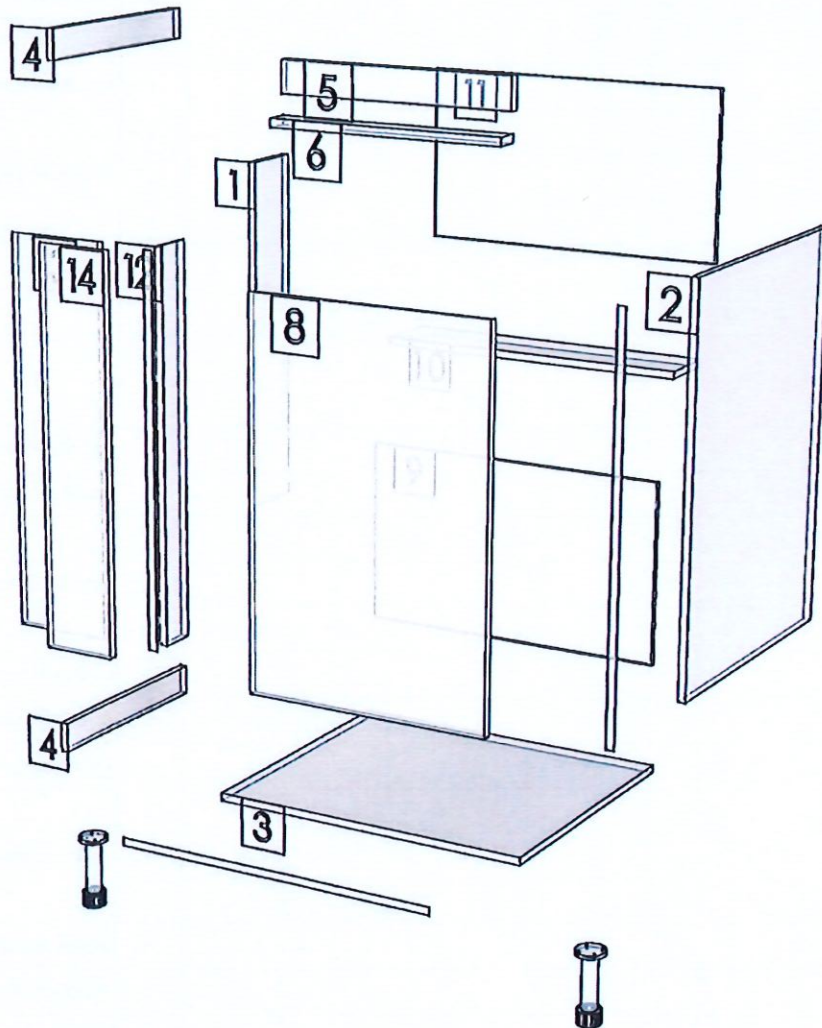

Model	ESCENT_PK2_DB164RS		
Creator	PASATHORN	.BCP Name	INDEX_C3D_KITCHEN2
Reviewer		Order	I004551
Approves	<i>P. SAWMI</i>	Date	21/10/2025

ESCENT_PK2_DB164RS-214X570X922

1

Colour

05.30 ML WHITE SAND #VM1012/2610/2610(PEARL)_
05.79 ML.NATURAL ASH (VM20682/2097/2097)_

-
-
-

Edge

01.47 1 WHITE _
01.421 1 NATURAL ASH (DA56-11001-M0) _

-
-
-

R&D REVIEW

- DWG.Customer
- Work Report
- Function
- สินค้าตรงตัวอย่าง

ผู้ควบคุม *P. SAWMI*
31 / 10 / 2025

K3R-160170395

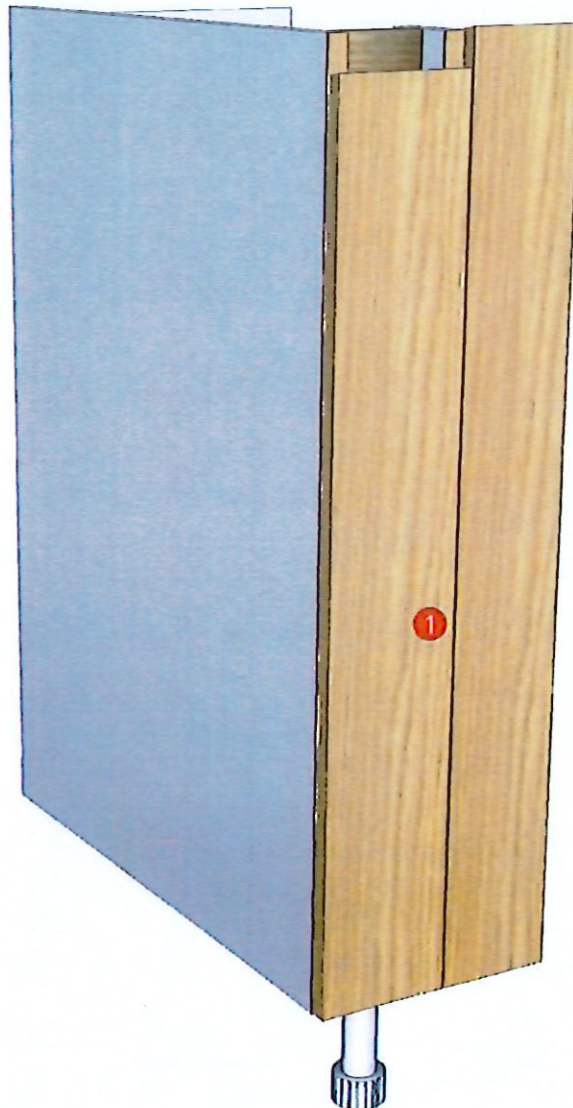

Model	-ESCENT_PK2_DB164RS		
Creator		.BCP Name	INDEX_C3D_KITCHEN2
Reviewer		Order	I004551
Approves	<i>P.SAWAI</i>	Date	

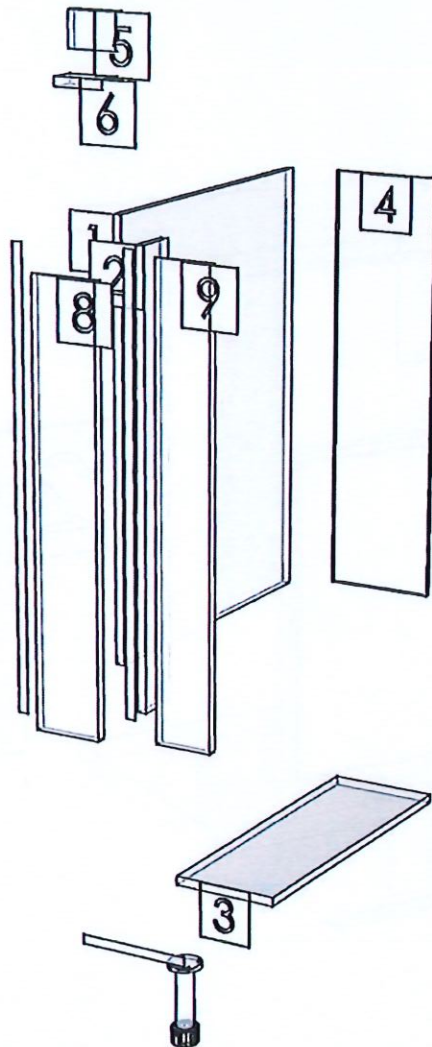

Model	ESCENT_PK2_DBO666L		
Creator	PASATHORN	.BCP Name	INDEX_C3D_KITCHEN2
Reviewer		Order	I004369
Approves	P.SAWAI	Date	21/08/2025

ESCENT_PK2_DBO666L-666X570X922

Colour

05.30 ML WHITE SAND #VM1012/2610/2610(PEARL)_
05.79 ML.NATURAL ASH (VM20682/2097/2097)_

-
-
-

Edge

01.47 1 WHITE _
01.421 1 NATURAL ASH (DA56-11001-M0)_

-
-
-

R&D REVIEW

- DWG.Customer
 - Work Report
 - Function
 - สินค้าตรงตัวอย่าง
- ผู้ทบทวน P.SAWAI
21 / 11 / 2025

K3R-160170395
K4L-160168276

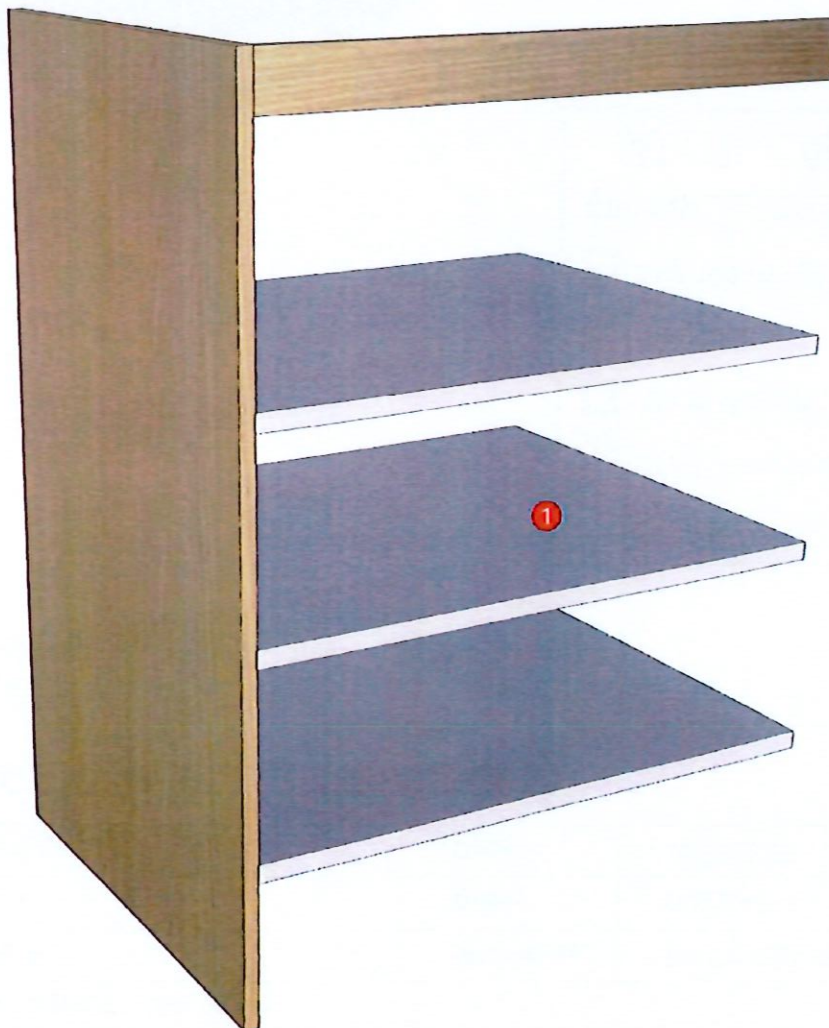

PRODUCT SIZE DRAWING :W666 X D570 X H922

Model	-ESCENT_PK2_DBO666L		
Creator		.BCP Name	INDEX_C3D_KITCHEN2
Reviewer		Order	I004369
Approves	P.SAWA1	Date	

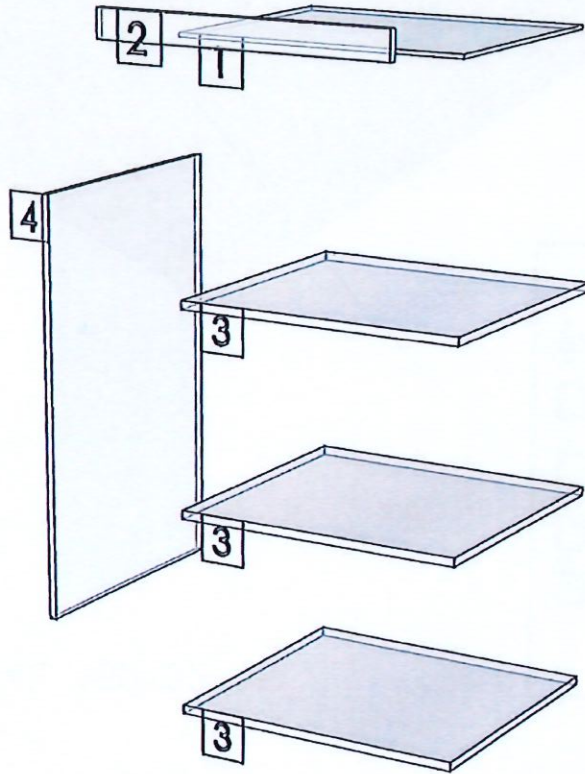

Model	ESCENT_PK2_DLMV60R		
Creator	PASATHORN	.BCP Name	INDEX_C3D_KITCHEN2
Reviewer		Order	I003117
Approves	P. SAWAI	Date	21/05/2024

ESCENT_PK2_DLMV60R-600X350X800

Colour
 05.30 ML WHITE SAND #VM1012/2610/2610(PEARL)_
 -
 -
 -
 -

Edge
 01.47 1 WHITE _
 -
 -
 -
 -

R&D REVIEW

DWG.Customer

Work Report

Function

สินค้าตรงตัวอย่าง

ผู้ควบคุม P.SAWAI

29 / 10 / 68

K2R-160137719

K3R-160170395_ED

K4L-160168276

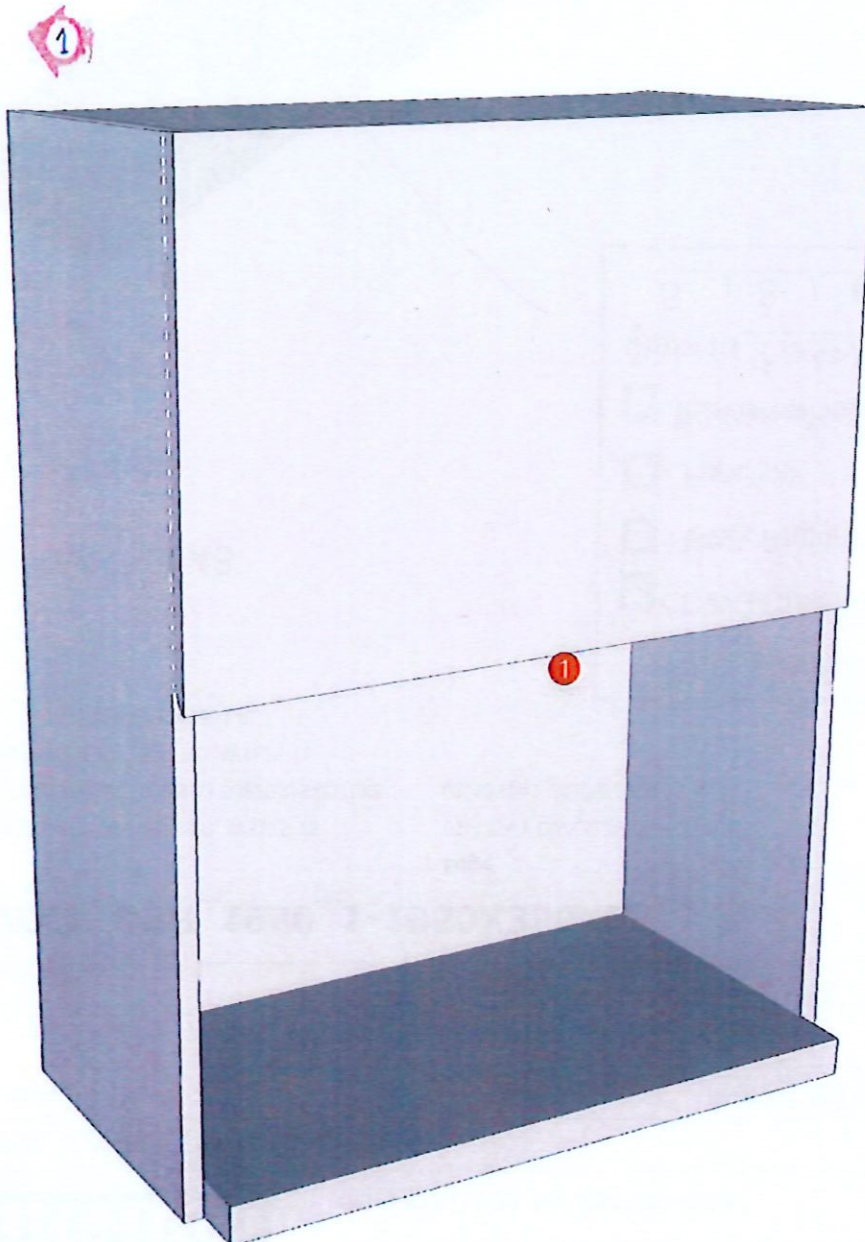

Model	-ESCENT_PK2_DLMV60R		
Creator		.BCP Name	INDEX_C3D_KITCHEN2
Reviewer		Order	I003117
Approves	P. SAWAI	Date	

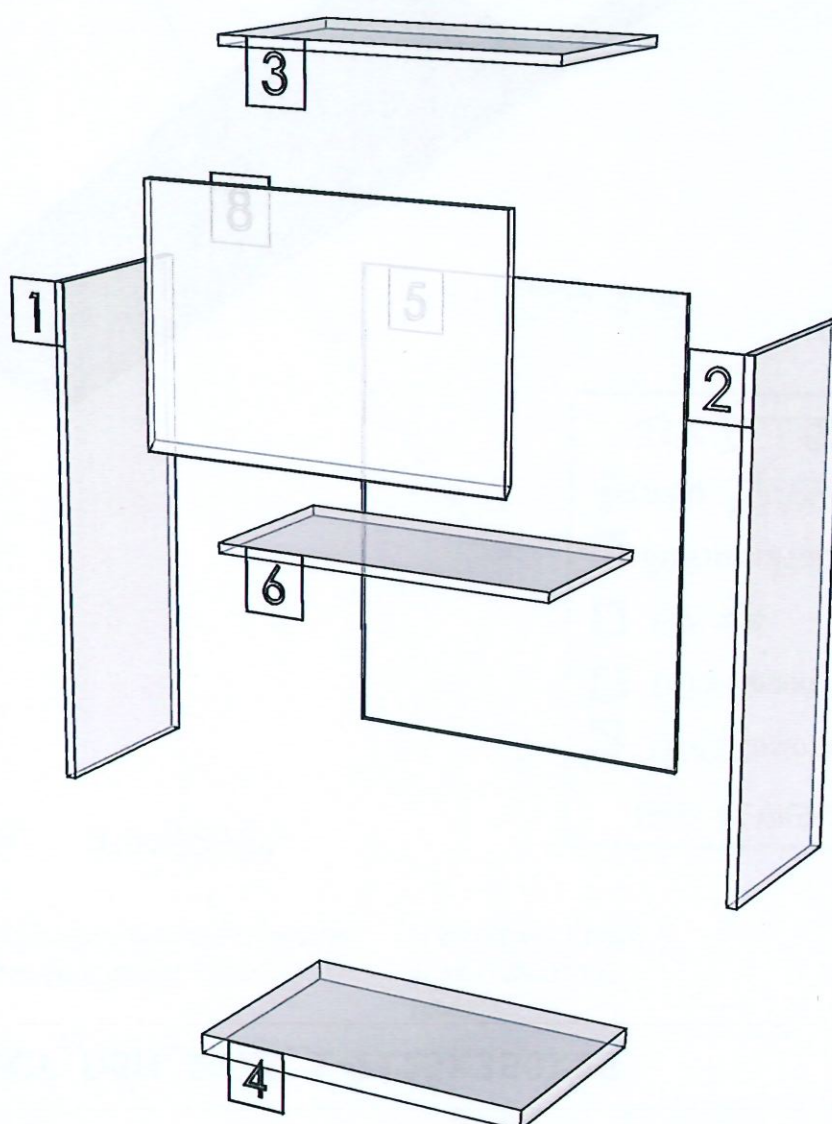

Model	ESCENT_PK2_DL50L		
Creator	PASATHORN	.BCP Name	INDEX_C3D_KITCHEN2
Reviewer		Order	I004547
Approves	P.SAWAI	Date	20/10/2025

ESCENT_PK2_DL50L-500X300X640

Colour

05.30 ML WHITE SAND #VM1012/2610/2610(PEARL)_

-
-
-
-

Edge

01.47 1 WHITE _

-
-
-
-

R&D REVIEW

- DWG.Customer
 - Work Report
 - Function
 - สืบค้นจริงตัวอย่าง
- ผู้ควบคุม P.SAWAI
29 / 10 / 2025

K3R-160170395

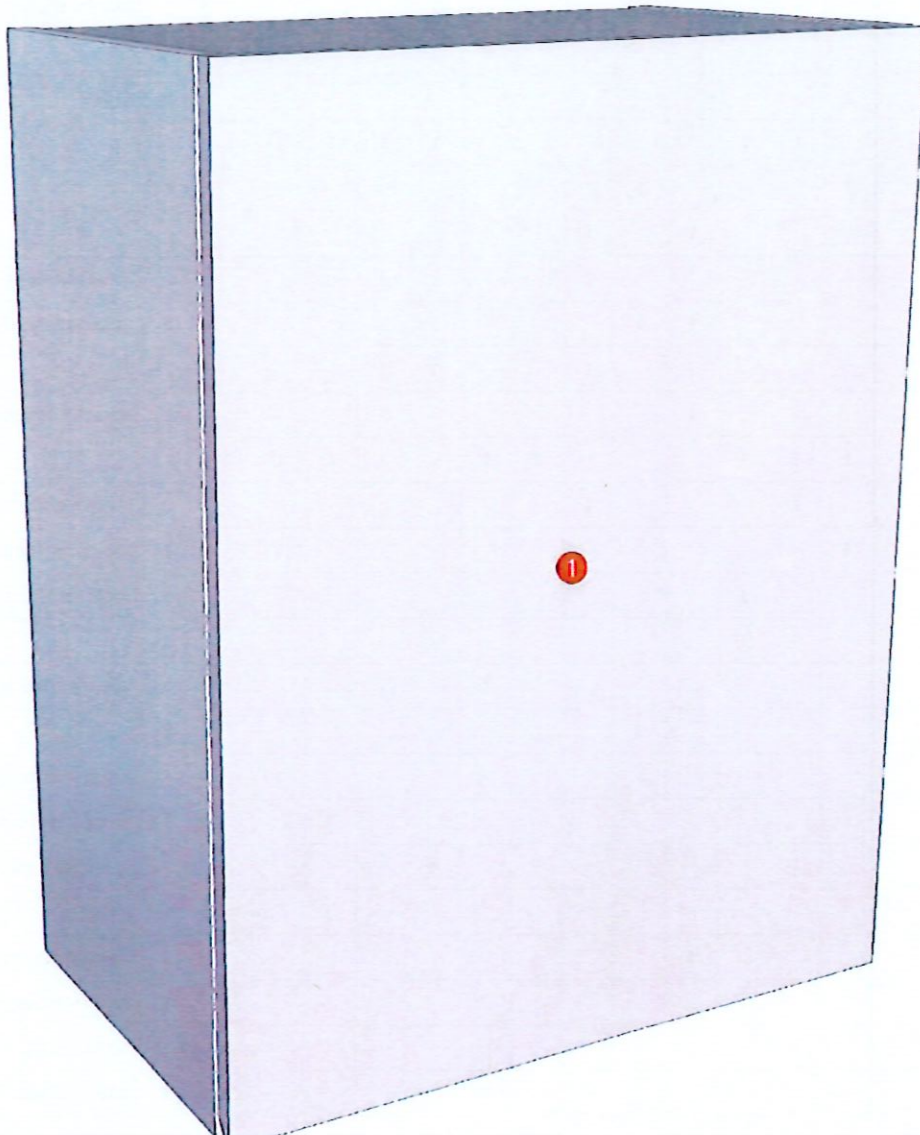

PRODUCT SIZE DRAWING :W500 X D300 X H640

PAGE 1

Model	-ESCENT_PK2_DL50L		
Creator		.BCP Name	INDEX_C3D_KITCHEN2
Reviewer		Order	I004547
Approves	M. JAWA, I	Date	

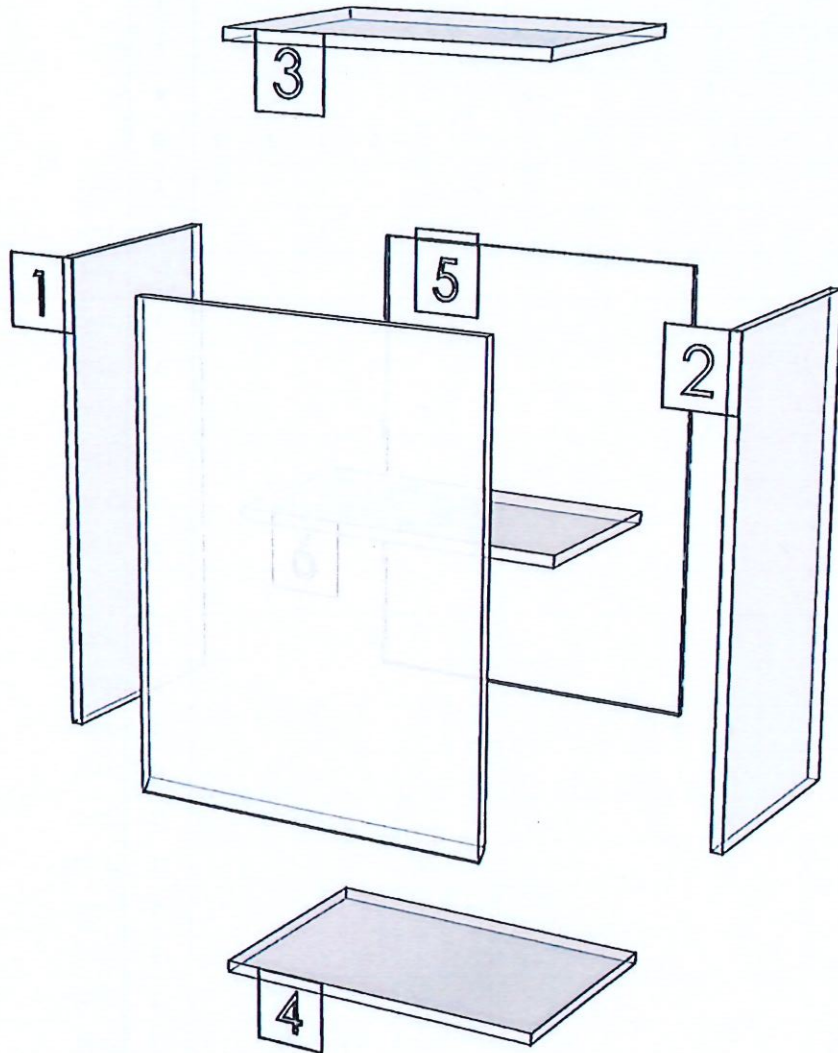

Model	ESCENT_PK2_DL15RD		
Creator	PASATHORN	.BCP Name	INDEX_C3D_KITCHEN2
Reviewer		Order	I004549
Approves	<i>P. SAWAI</i>	Date	21/10/2025

ESCENT_PK2_DL15RD-150X400X640

Colour

05.30 ML WHITE SAND #VM1012/2610/2610(PEARL)_

-
-
-
-

Edge

01.47 1 WHITE _

-
-
-
-

R&D REVIEW

DWG.Customer

Work Report

Function

สินค้าตรงตัวอย่าง

ผู้ควบคุม *P. SAWAI*

29 / 10 / 2025

K3R-160170395

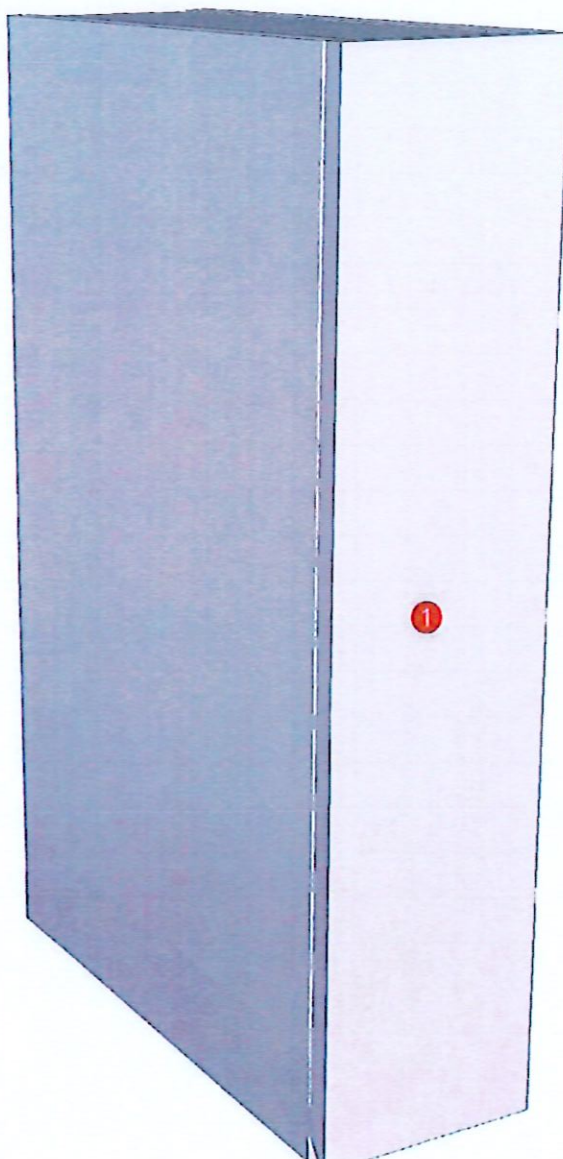

PRODUCT SIZE DRAWING :W150 X D400 X H640

PAGE 1

Model	-ESCENT_PK2_DL15RD		
Creator		.BCP Name	INDEX_C3D_KITCHEN2
Reviewer		Order	I004549
Approves	P. JAWWI	Date	

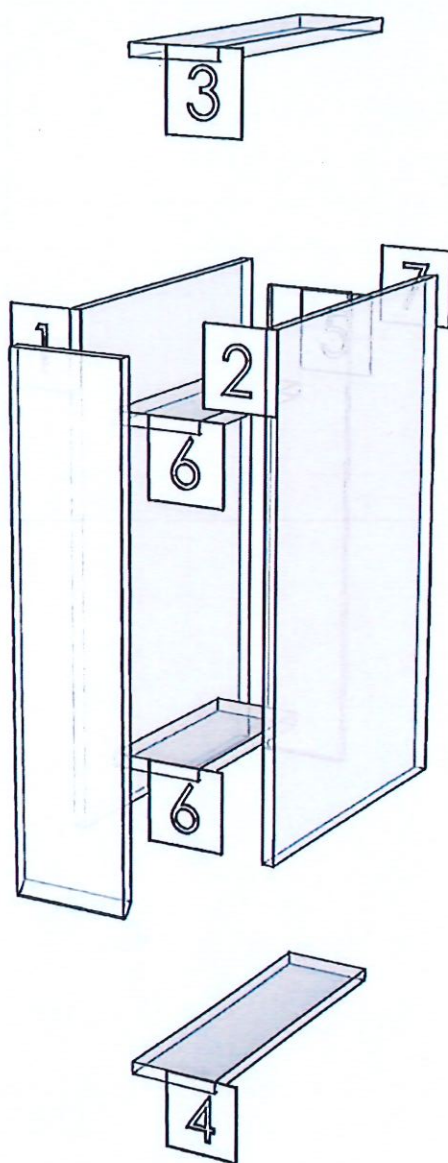

Model	ESCENT_PK2_DL60HRD		
Creator	PASATHORN	.BCP Name	INDEX_C3D_KITCHEN2
Reviewer		Order	I004550
Approves	P.SAWAI	Date	21/10/2025

ESCENT_PK2_DL60HRD-600X400X600

Colour

05.30 ML WHITE SAND #VM1012/2610/2610(PEARL)_

-
-
-
-

Edge

01.47 1 WHITE _

-
-
-
-

R&D REVIEW

- DWG.Customer
 - Work Report
 - Function
 - สินค้าจริงตัวอย่าง
- ผู้ควบคุม P.SAWAI
29 / 10 / 2025

K3R-160170395

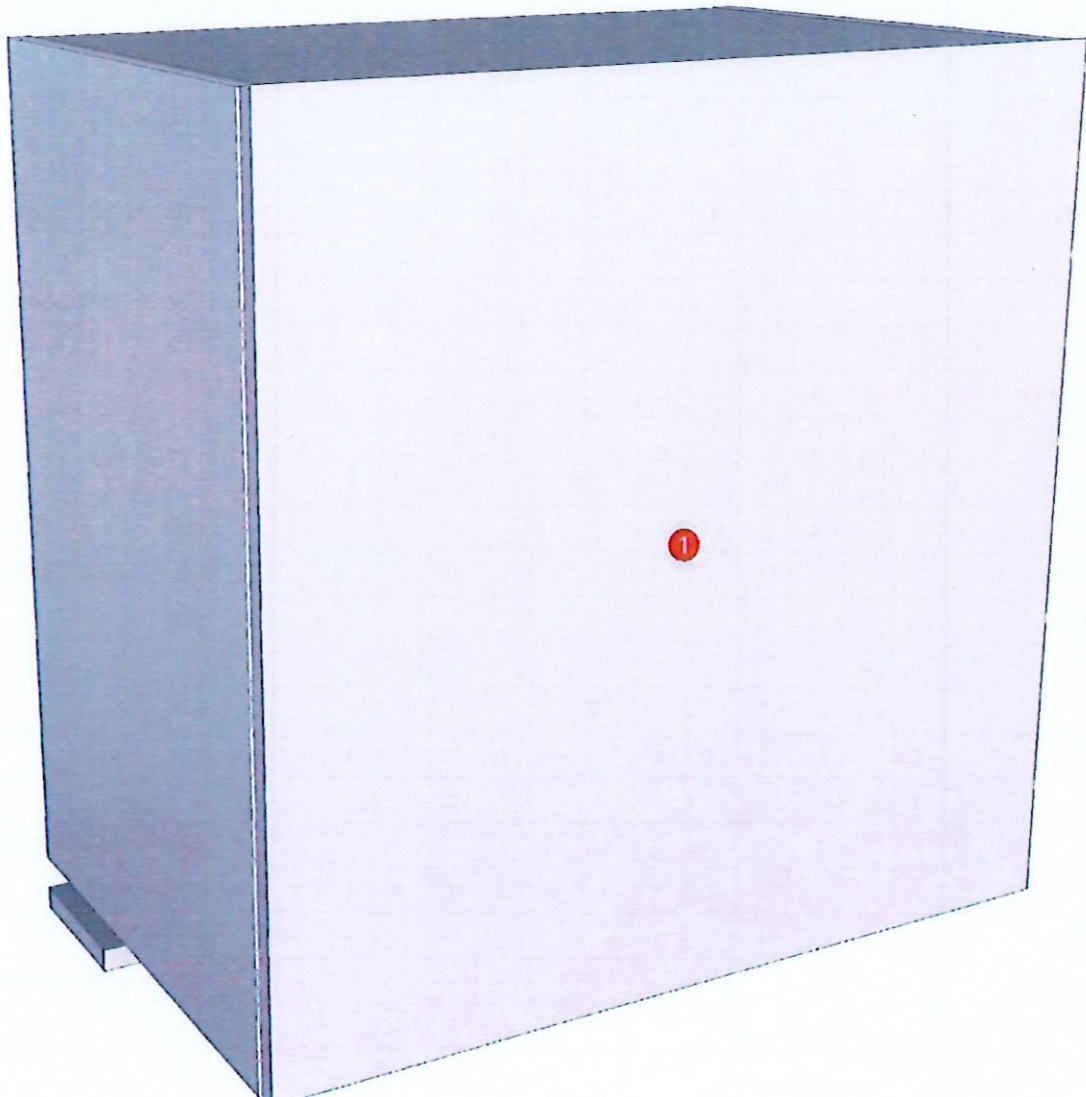

PRODUCT SIZE DRAWING :W600 X D400 X H600

PAGE 1

Model	-ESCENT_PK2_DL60HRD		
Creator		.BCP Name	INDEX_C3D_KITCHEN2
Reviewer		Order	I004550
Approves	P.SAWA I	Date	

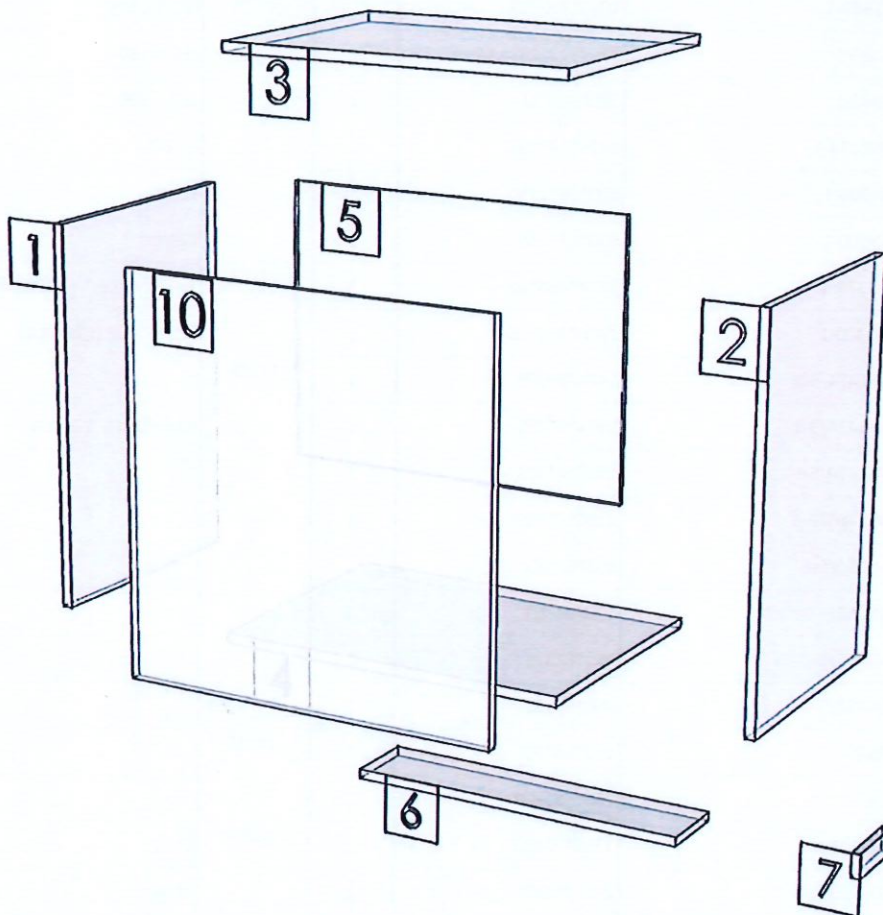

Model	ESCENT_PK2_DEPB		
Creator	PASATHORN	.BCP Name	INDEX_C3D_KITCHEN2
Reviewer		Order	I003113
Approves	P. SAWAI	Date	21/05/2024

ESCENT_PK2_DEPB-16X590X772

Colour

05.79 ML.NATURAL ASH (VM20682/2097/2097)_

-

-

-

K1L-160170387_ED

1

K1R-160137711

K2L-160168268

K2R-160137719

K3L-160169110

K3R-160170395_ED

1

Edge

01.421 1 NATURAL ASH (DA56-11001-M0)_

-

-

-

-

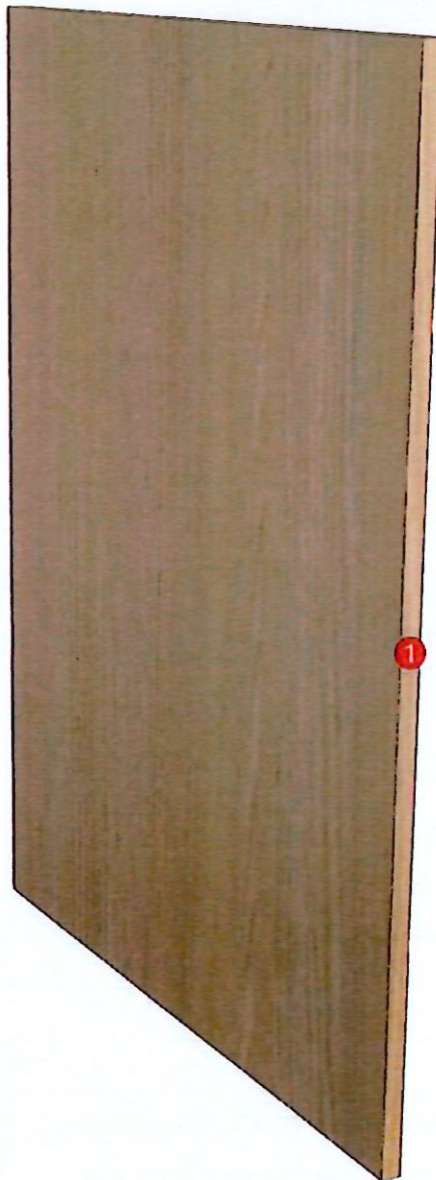

R&D REVIEW

DWG.Customer

Work Report

Function

สินค้าตรงตัวอย่าง

ผู้กบหน P.SAWAI

29 / 10 68

Model	ESCENT_PK2_DFL		
Creator	PASATHORN	.BCP Name	INDEX_C3D_KITCHEN2
Reviewer		Order	I004365
Approves	<i>P. SAWAI</i>	Date	20/08/2025

ESCENT_PK2_DFL-150X16X640

Colour

05.30 ML WHITE SAND #VM1012/2610/2610(PEARL)_

-
-
-
-

Edge

01.47 1 WHITE _

-
-
-
-

R&D REVIEW

- DWG. Customer
- Work Report
- Function
- สืบค้นตรงตัวอย่าง

ผู้กบแทน *P. SAWAI*
29 / 10 / 68

K3L-160169110
K3R-160170395_ED

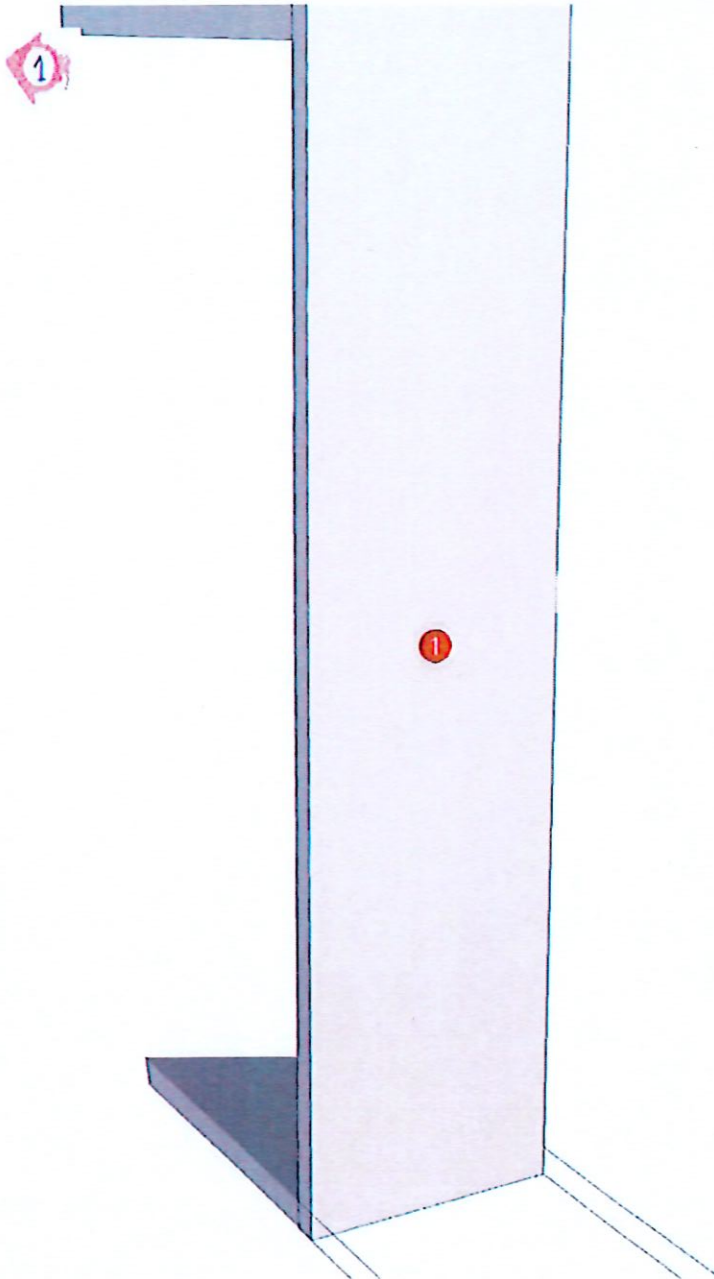

Model	-ESCENT_PK2_DFL		
Creator		.BCP Name	INDEX_C3D_KITCHEN2
Reviewer		Order	I004365
Approves	พ. SAWAN	Date	

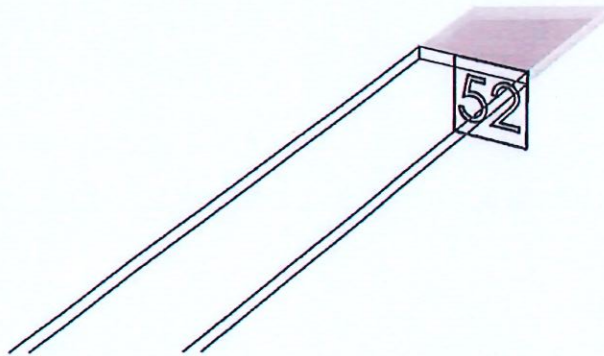

Model	ESCENT_PK2_DF_CL1200		
Creator	PASATHORN	.BCP Name	INDEX_C3D_KITCHEN2
Reviewer		Order	I004407
Approves	P. SAWAI	Date	08/09/2025

ESCENT_PK2_DF_CL1200-1200X9X370

Colour	Edge
05.30 ML WHITE SAND #VM1012/2610/2610(PEARL)_	01.47 1 WHITE _
-	-
-	-
-	-
-	-

R&D REVIEW

- DWG.Customer
- Work Report
- Function
- สินค้าตรงตัวอย่าง

ผู้ควบคุม P. SAWAI
29 / 10 / 68

K3L-160169110
K3R-160170395_ED

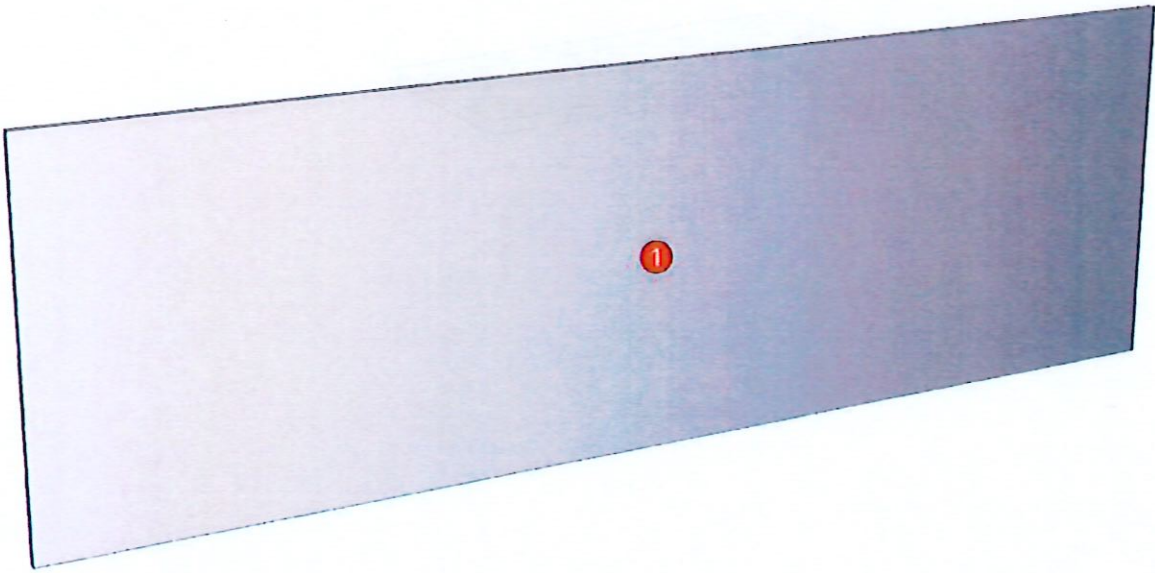

Model	ESCENT_PK2_DF_CL850		
Creator	PASATHORN	.BCP Name	INDEX_C3D_KITCHEN2
Reviewer		Order	I004406
Approves	P. SAWAI	Date	08/09/2025

ESCENT_PK2_DF_CL850-850X9X370

Colour

05.30 ML WHITE SAND #VM1012/2610/2610(PEARL)_

-
-
-
-

Edge

01.47 1 WHITE _

-
-
-
-

R&D REVIEW

- DWG.Customer
- Work Report
- Function
- สินค้าตรงตัวอย่าง

ผู้กบทวน P.SAWAI
29 / 10 / 68

K3L-160169110

K3R-160170395_ED

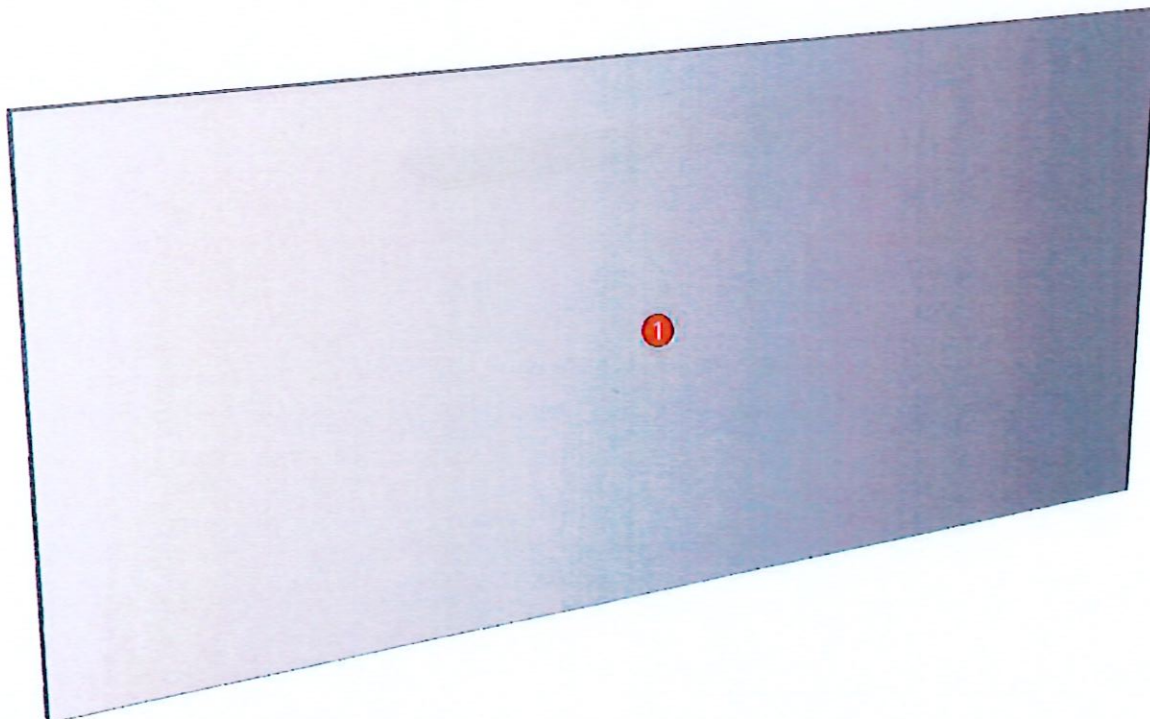

Model	ESCENT_PK2_DF_CL300		
Creator	PASATHORN	.BCP Name	INDEX_C3D_KITCHEN2
Reviewer		Order	I003108
Approves	P. SAWAI	Date	21/05/2024

ESCENT_PK2_DF_CL300-300X9X370

Colour

05.30 ML WHITE SAND #VM1012/2610/2610(PEARL)_

-

-

K1L-160170387_ED 1

K1R-160137711

K2L-160168268

K2R-160137719

K3L-160169110

K4L-160168276

Edge

01.47 1 WHITE _

-

-

-

-

R&D REVIEW

DWG.Customer

Work Report

Function

สินค้าตรงตัวอย่าง

ผู้ควบคุม P. SAWAI

29 / 10 / 68

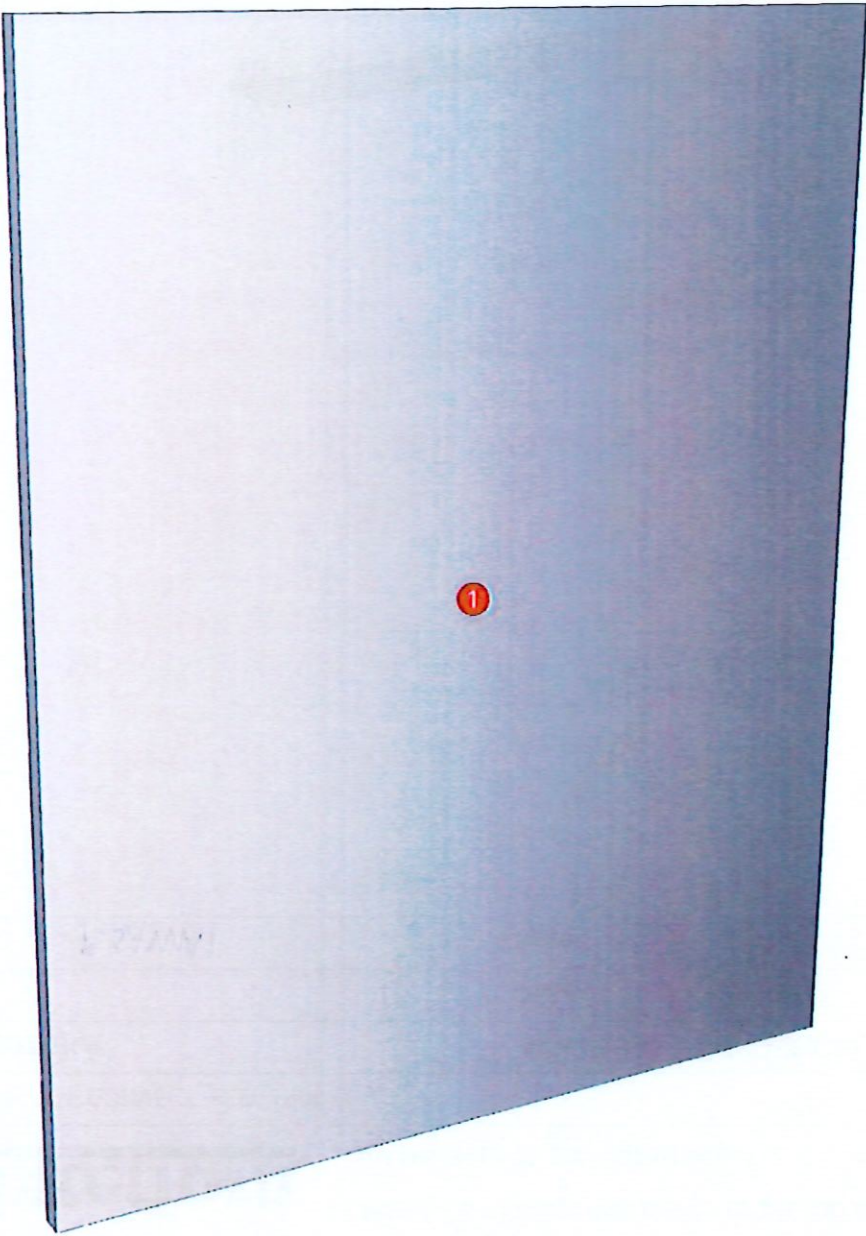

Model	ESCENT_PK2_DF_CL400		
Creator	PASATHORN	.BCP Name	INDEX_C3D_KITCHEN2
Reviewer		Order	I004544
Approves	P. SAWAI	Date	17/10/2025

ESCENT_PK2_DF_CL400-400X16X370

Colour

05.30 ML WHITE SAND #VM1012/2610/2610(PEARL)_

-
-
-
-

Edge

01.47 1 WHITE _

-
-
-
-

R&D REVIEW

- DWG.Customer
- Work Report
- Function
- สืบค้นจริงตัวอย่าง

ผู้ควบคุมงาน P. SAWAI

29 / 10 / 68

K3L-160169110

K3R-160170395_ED

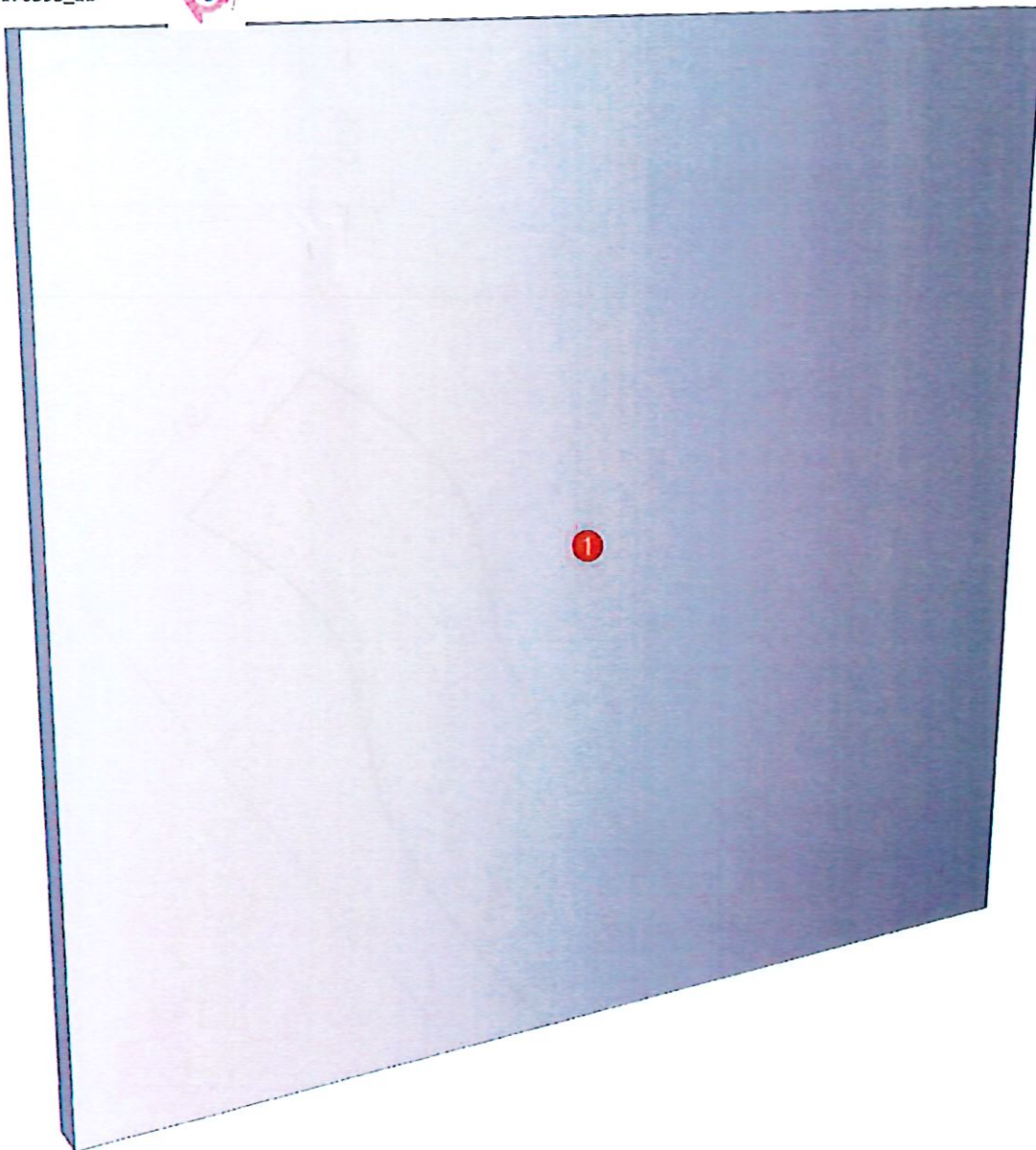

Model	ESCENT_PK2_DUT1200		
Creator	PASATHORN	.BCP Name	INDEX_C3D_KITCHEN2
Reviewer		Order	I004405
Approves	<i>P. SAWAI</i>	Date	08/09/2025

ESCENT_PK2_DUT1200-1200X60X9

Colour

05.01 ML WHITE VM1012 18/18_

-

-

-

-

Edge

01.47 1 WHITE _

-

-

-

-

R&D REVIEW

DWG.Customer

Work Report

Function

สินค้าตรงตัวอย่าง

ผู้ควบคุม *P. SAWAI*

29 / 10 / 68

K3L-160169110

K3R-160170395_ED

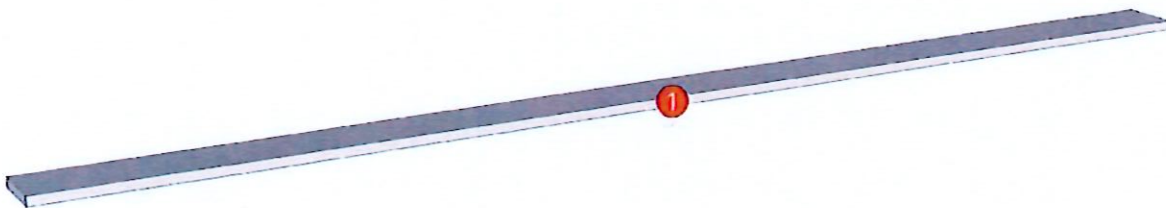

Model	ESCENT_PK2_DUT800		
Creator	PASATHORN	.BCP Name	INDEX_C3D_KITCHEN2
Reviewer		Order	I004404
Approves	P. SAWAI	Date	08/09/2025

ESCENT_PK2_DUT800-800X60X9

Colour

05.01 ML WHITE VM1012 18/18_

-
-
-
-

Edge

01.47 1 WHITE _

-
-
-
-

R&D REVIEW

- DWG.Customer
- Work Report
- Function
- สินค้าตรงตัวอย่าง

ผู้ควบคุม P.SAWAI
29, 10 68

K3L-160169110

K3R-160170395_ED

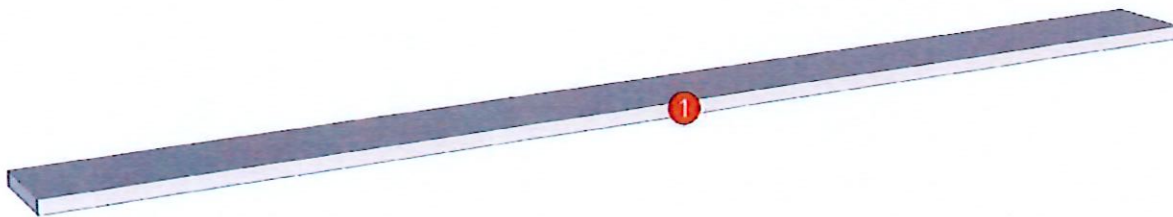

Model	ESCENT_PK2_DUT500		
Creator	PASATHORN	.BCP Name	INDEX_C3D_KITCHEN2
Reviewer		Order	I003107
Approves	P. SAWAI	Date	21/05/2024

ESCENT_PK2_DUT500-500X60X9

Colour

05.01 ML WHITE VM1012 18/18_

-

-

-

K1L-160170387_ED

1

K1R-160137711

K2L-160168268

K2R-160137719

K3L-160169110

K3R-160170395_ED

1

K4L-160168276

Edge

01.47 1 WHITE _

-

-

-

-

R&D REVIEW

DWG.Customer

Work Report

Function

สินค้าตรงตัวอย่าง

ผู้ควบคุม P. SAWAI

29 / 10 / 68

