

<b>Model</b>	LIFE_CN2_DBD20G		
<b>Creator</b>	PASATHORN	<b>.BCP Name</b>	INDEX_C3D_KITCHEN2
<b>Reviewer</b>		<b>Order</b>	I004475
<b>Approves</b>	P.SAWAI	<b>Date</b>	13/10/2025

## **LIFE\_CN2\_DBD20G-200X570X913**

### **Colour**

05.38 ML MD692 (SS)\_  
05.30 ML WHITE SAND #VM1012/2610/2610(PEARL)\_  
-  
-  
-

### **Edge**

01.286 1 MD692 \_  
-  
-  
-

<b>R&amp;D REVIEW</b>	
<input checked="" type="checkbox"/>	DWG.Customer
<input checked="" type="checkbox"/>	Work Report
<input type="checkbox"/>	Function
<input type="checkbox"/>	สินค้าตรงตัวอย่าง
ผู้ทบทวน <u>P.SAWAI</u>	
<u>25/10/25</u>	

K103L-160169906  
K103R-160169916

K116L-160170007  
K116R-160170018



<b>Model</b>	-LIFE_CN2_DBD20G		
<b>Creator</b>		<b>.BCP Name</b>	INDEX_C3D_KITCHEN2
<b>Reviewer</b>		<b>Order</b>	I004475
<b>Approves</b>	P.SAWAI	<b>Date</b>	

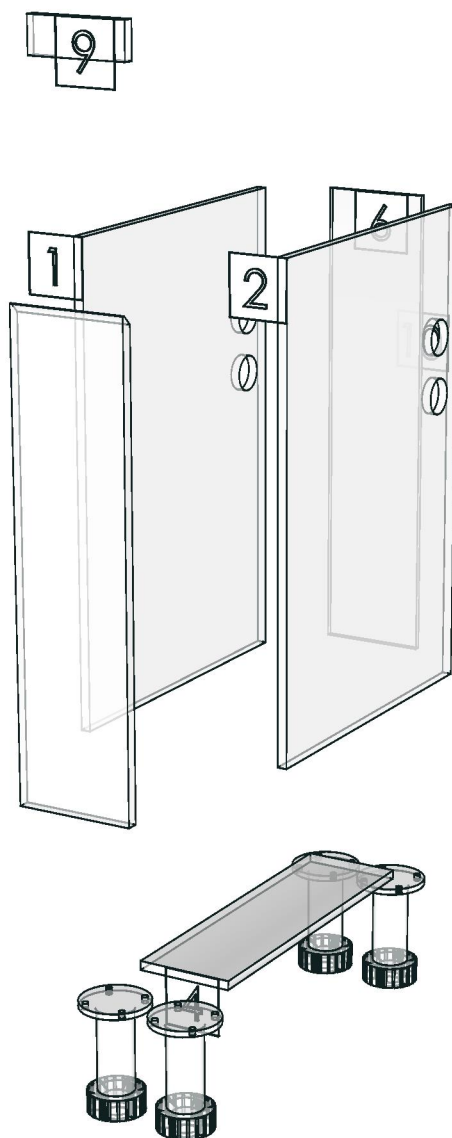

<b>Model</b>	LIFE_CN2_DBO698R		
<b>Creator</b>	PASATHORN	<b>.BCP Name</b>	INDEX_C3D_KITCHEN2
<b>Reviewer</b>		<b>Order</b>	I004484
<b>Approves</b>	P.SAWAI	<b>Date</b>	13/10/2025

## **LIFE\_CN2\_DBO698R-698X570X913**

### **Colour**

05.38 ML MD692 (SS)\_  
05.30 ML WHITE SAND #VM1012/2610/2610(PEARL)\_  
-  
-  
-

### **Edge**

01.286 1 MD692 \_  
01.47 1 WHITE \_  
-  
-  
-

**R&D REVIEW**

- DWG.Customer
- Work Report
- Function
- สินค้าตรงตัวอย่าง

ผู้ทบทวน P.SAWAI  
25/10/25

K103L-160169906

K116L-160170007

K104L-160169926

K117L-160170029

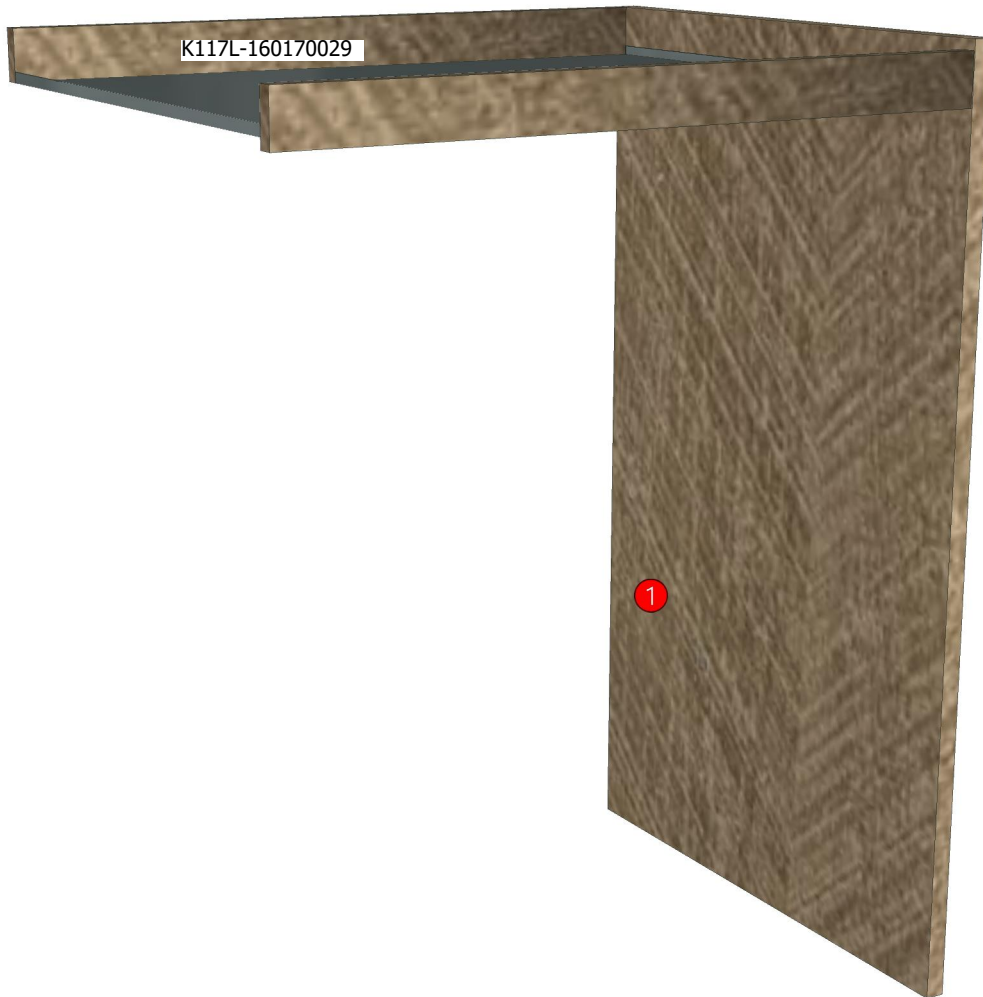

<b>Model</b>	-LIFE_CN2_DBO698R		
<b>Creator</b>		<b>.BCP Name</b>	INDEX_C3D_KITCHEN2
<b>Reviewer</b>		<b>Order</b>	I004484
<b>Approves</b>	P. SAWAI	<b>Date</b>	

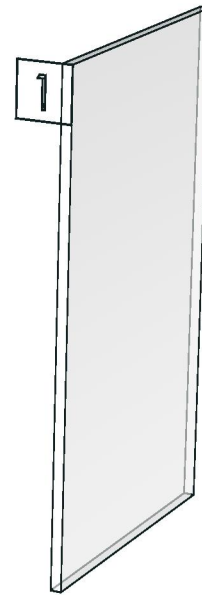
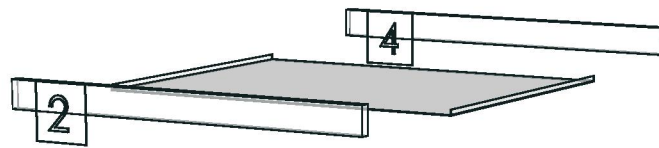

<b>Model</b>	LIFE_CN2_DBS60LGR		
<b>Creator</b>	PASATHORN	<b>.BCP Name</b>	INDEX_C3D_KITCHEN2
<b>Reviewer</b>		<b>Order</b>	I004485
<b>Approves</b>		<b>Date</b>	13/10/2025

## LIFE\_CN2\_DBS60LGR-600X570X913

**Colour**

05.38 ML MD692 (SS)\_  
05.30 ML WHITE SAND #VM1012/2610/2610(PEARL)\_

**Edge**

01.286 1 MD692 \_  
01.465 0.6 CHARLOTTE MD692 (A1519TH00)\_

**R&D REVIEW**

DWG.Customer

Work Report

Function

สินค้าตรงตัวอย่าง

ผู้ทบทวน \_\_\_\_\_

K103L-160169906

K116L-160170007\_E

K104L-160169926

K117L-160170029\_E

K105L-160169936

K118L-160170040\_E

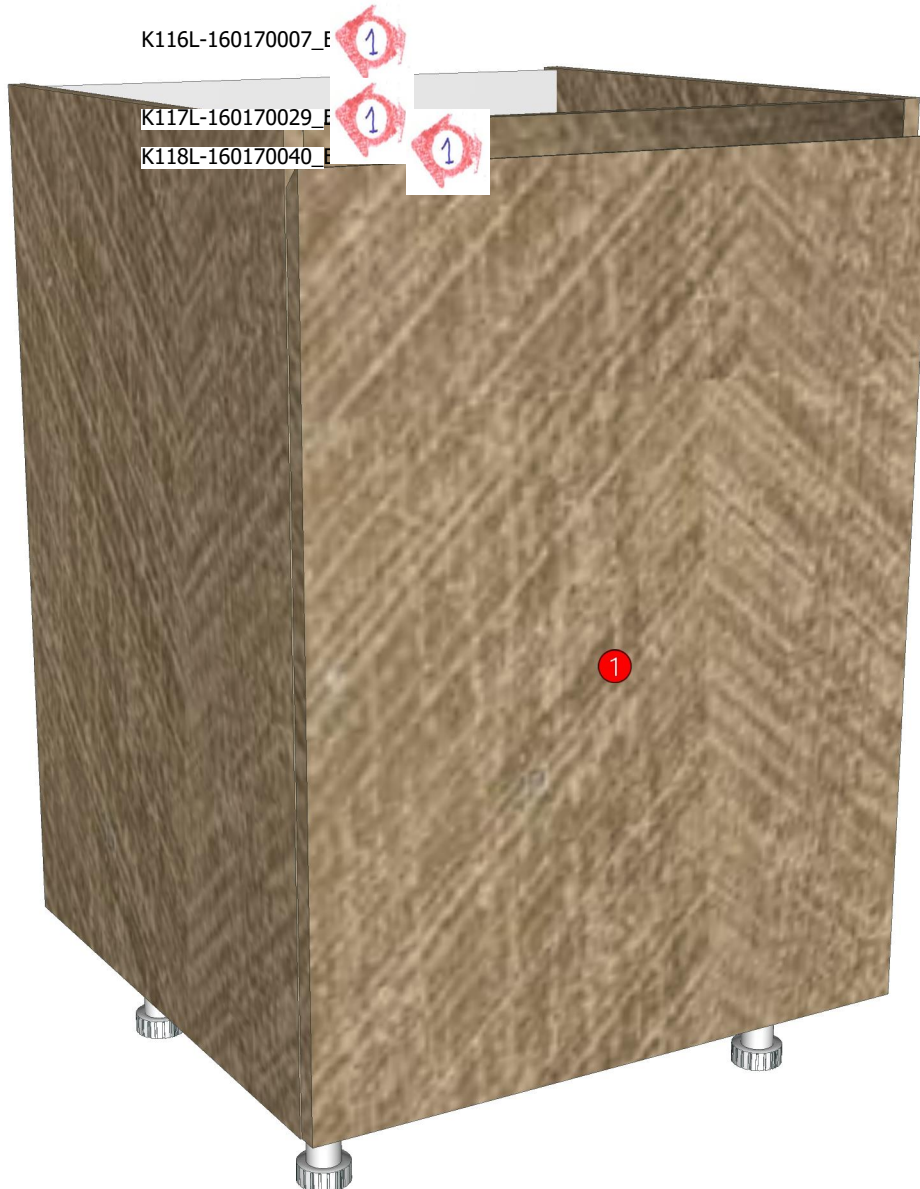

<b>Model</b>	-LIFE_CN2_DBS60LGR		
<b>Creator</b>		<b>.BCP Name</b>	INDEX_C3D_KITCHEN2
<b>Reviewer</b>		<b>Order</b>	I004485
<b>Approves</b>		<b>Date</b>	

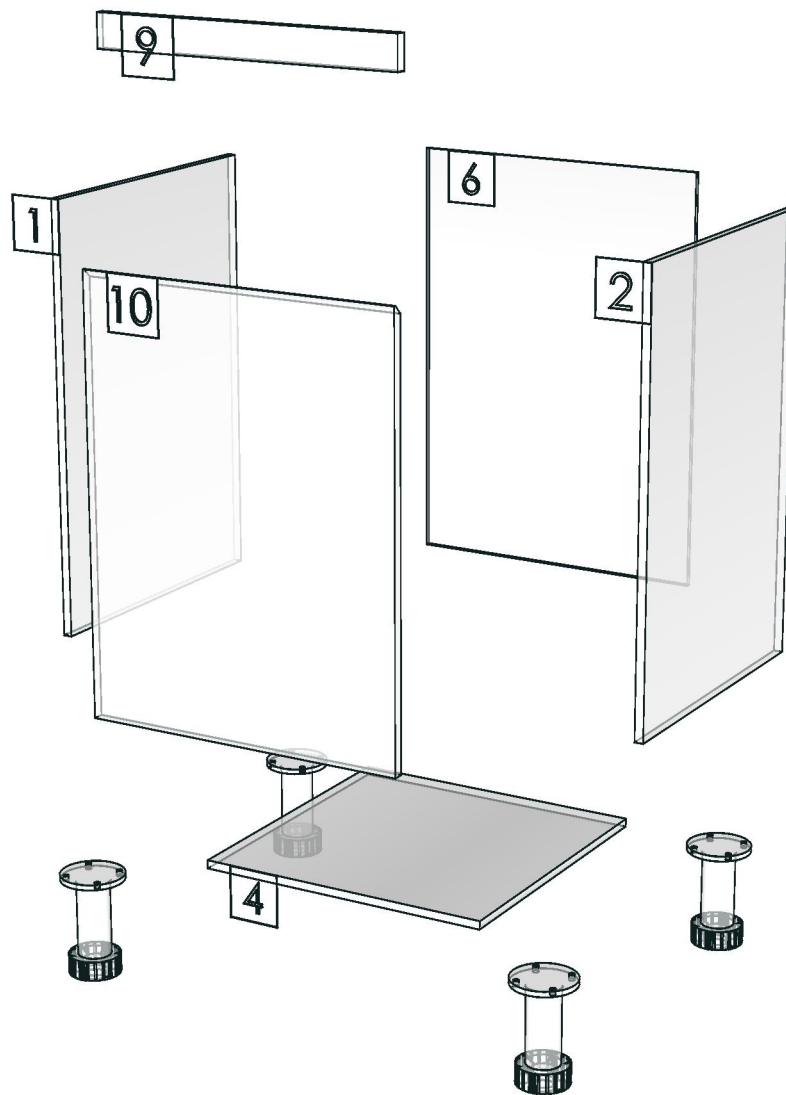

<b>Model</b>	LIFE_CN2_DDM700		
<b>Creator</b>	PASATHORN	<b>.BCP Name</b>	INDEX_C3D_KITCHEN2
<b>Reviewer</b>		<b>Order</b>	I004494
<b>Approves</b>	P.SAWAI	<b>Date</b>	13/10/2025

## **LIFE\_CN2\_DDM700-700X16X150**

### **Colour**

05.38 ML MD692 (SS)\_

-  
-  
-  
-

K101L-160169866

K101R-160169877

K103L-160169906

K103R-160169916

K104L-160169926

### **Edge**

01.286 1 MD692 \_

-  
-  
-  
-

K114L-160169963

K114R-160169975

K116L-160170007

K116R-160170018

K117L-160170029

<b>R&amp;D REVIEW</b>	
<input checked="" type="checkbox"/>	DWG.Customer
<input checked="" type="checkbox"/>	Work Report
<input type="checkbox"/>	Function
<input type="checkbox"/>	สินค้าตรงตัวอย่าง
ผู้ทบทวน <u>P.SAWAI</u>	
<u>25/10/25</u>	

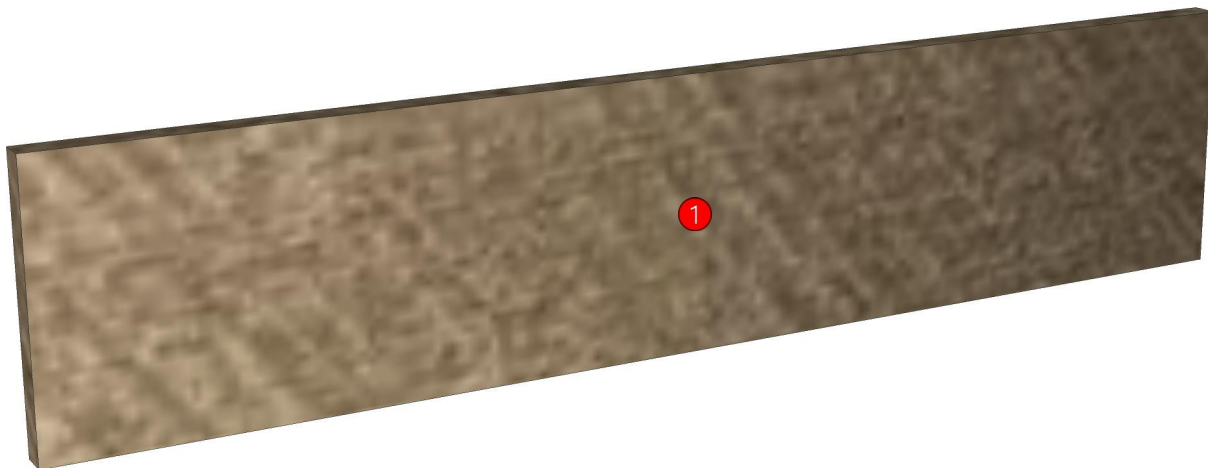

<b>Model</b>	LIFE_CN2_DDM700		
<b>Creator</b>	PASATHORN	<b>.BCP Name</b>	INDEX_C3D_KITCHEN2
<b>Reviewer</b>		<b>Order</b>	I004494
<b>Approves</b>	P. SAWAI	<b>Date</b>	13/10/2025

No.	Article No.	Description	Mat	Dimension	Cutting Size	Typepology	Skin
0	LIFE_CN2_DDM700	LIFE_CN2_DDM700		700x150x16			
	LIFE_CN2_DDM700-01	DDM-SP	PB-SP	16x150x700	16X148X699;L2:W1	183000 _STR=05.38 _EDG=MD692-1	2

<b>Model</b>	LIFE_CN2_DFLH		
<b>Creator</b>	PASATHORN	<b>.BCP Name</b>	INDEX_C3D_KITCHEN2
<b>Reviewer</b>		<b>Order</b>	I004530
<b>Approves</b>		<b>Date</b>	16/10/2025

## **LIFE\_CN2\_DFLH-150X16X1100**

**Colour**

05.38 ML MD692 (SS)\_

-  
-  
-  
-

**Edge**

01.286 1 MD692 \_

-  
-  
-  
-

K114L-160169963

K114R-160169975

K116L-160170007

K116R-160170018

K117L-160170029

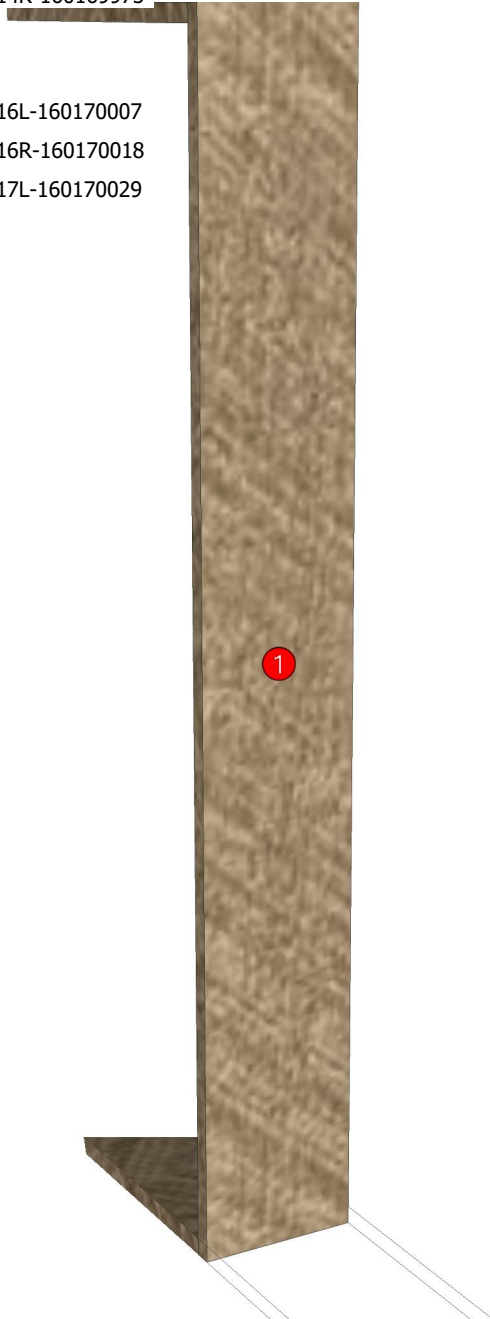

<b>R&amp;D REVIEW</b>	
<input checked="" type="checkbox"/>	DWG.Customer
<input checked="" type="checkbox"/>	Work Report
<input type="checkbox"/>	Function
<input type="checkbox"/>	สินค้าตรงตัวอย่าง
ผู้ทบทวน _____	

<b>Model</b>	-LIFE_CN2_DFLH		
<b>Creator</b>		<b>.BCP Name</b>	INDEX_C3D_KITCHEN2
<b>Reviewer</b>		<b>Order</b>	I004530
<b>Approves</b>		<b>Date</b>	

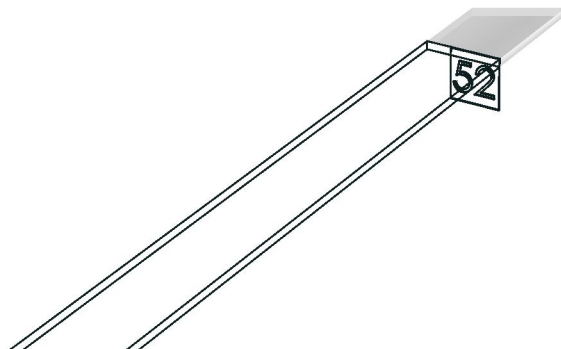

<b>Model</b>	LIFE_CN2_DF_CL1550H		
<b>Creator</b>	PASATHORN	<b>.BCP Name</b>	INDEX_C3D_KITCHEN2
<b>Reviewer</b>		<b>Order</b>	I004526
<b>Approves</b>		<b>Date</b>	16/10/2025

## **LIFE\_CN2\_DF\_CL1550H-1550X16X355**

**Colour**

05.38 ML MD692 (SS)\_

-  
-  
-  
-

**Edge**

01.286 1 MD692 \_

-  
-  
-  
-

<b>R&amp;D REVIEW</b>	
<input checked="" type="checkbox"/>	DWG.Customer
<input checked="" type="checkbox"/>	Work Report
<input type="checkbox"/>	Function
<input type="checkbox"/>	สินค้าตรงตัวอย่าง
ผู้ทบทวน _____	
_____	

K116L-160170007

K116R-160170018



<b>Model</b>	LIFE_CN2_DF_CL1550H		
<b>Creator</b>	PASATHORN	<b>.BCP Name</b>	INDEX_C3D_KITCHEN2
<b>Reviewer</b>		<b>Order</b>	I004526
<b>Approves</b>		<b>Date</b>	16/10/2025

No.	Article No.	Description	Mat	Dimension	Cutting Size	Typepology	Skin
0	LIFE_CN2_DF_CL1550H	LIFE_CN2_DF_CL1550H		1550x355x16			
	LIFE_CN2_DF_CL1550H-01	DF_CL-SP	PB-SP	16x355x1550	16X354X1549;L1:W1	183000 _STR=05.38 _EDG=MD692-1	2

<b>Model</b>	LIFE_CN2_DF_CL350H		
<b>Creator</b>	PASATHORN	<b>.BCP Name</b>	INDEX_C3D_KITCHEN2
<b>Reviewer</b>		<b>Order</b>	I003902
<b>Approves</b>		<b>Date</b>	31/01/2025

## **LIFE\_CN2\_DF\_CL350H-350X16X355**

**Colour**

05.38 ML MD692 (SS)\_

-  
-  
-  
-

**Edge**

01.286 1 MD692 \_

-  
-  
-  
-

K113L-160169945

K113R-160169954

K115L-160169987

K115R-160169997

K116L-160170007

K116R-160170018

K117L-160170029

K118L-160170040

**R&D REVIEW**

- DWG.Customer
- Work Report
- Function
- สินค้าตรงตัวอย่าง

ผู้ทบทวน \_\_\_\_\_



<b>Model</b>	LIFE_CN2_DF_CL350H		
<b>Creator</b>	PASATHORN	<b>.BCP Name</b>	INDEX_C3D_KITCHEN2
<b>Reviewer</b>		<b>Order</b>	I003902
<b>Approves</b>		<b>Date</b>	31/01/2025

No.	Article No.	Description	Mat	Dimension	Cutting Size	Typepology	Skin
0	LIFE_CN2_DF_CL350H	LIFE_CN2_DF_CL350H		350x355x16			
	LIFE_CN2_DF_CL350H-01	DF_CL-SP	PB-SP	16x355x350	16X354X349;L1:W1	183000 _STR=05.38 _EDG=MD692-1	2

<b>Model</b>	LIFE_CN2_DL60H1R		
<b>Creator</b>	PASATHORN	<b>.BCP Name</b>	INDEX_C3D_KITCHEN2
<b>Reviewer</b>		<b>Order</b>	I004542
<b>Approves</b>		<b>Date</b>	16/10/2025

## **LIFE\_CN2\_DL60H1R-600X350X1060**

### **Colour**

05.38 ML MD692 (SS)\_

05.30 ML WHITE SAND #VM1012/2610/2610(PEARL)\_

-

-

-

### **Edge**

01.286 1 MD692 \_

01.47 1 WHITE \_

-

-

-

K114L-160169963

<b>R&amp;D REVIEW</b>	
<input checked="" type="checkbox"/>	DWG.Customer
<input checked="" type="checkbox"/>	Work Report
<input type="checkbox"/>	Function
<input type="checkbox"/>	สินค้าตรงตัวอย่าง
ผู้ทบทวน _____	



<b>Model</b>	-LIFE_CN2_DL60H1R		
<b>Creator</b>		<b>.BCP Name</b>	INDEX_C3D_KITCHEN2
<b>Reviewer</b>		<b>Order</b>	I004542
<b>Approves</b>		<b>Date</b>	

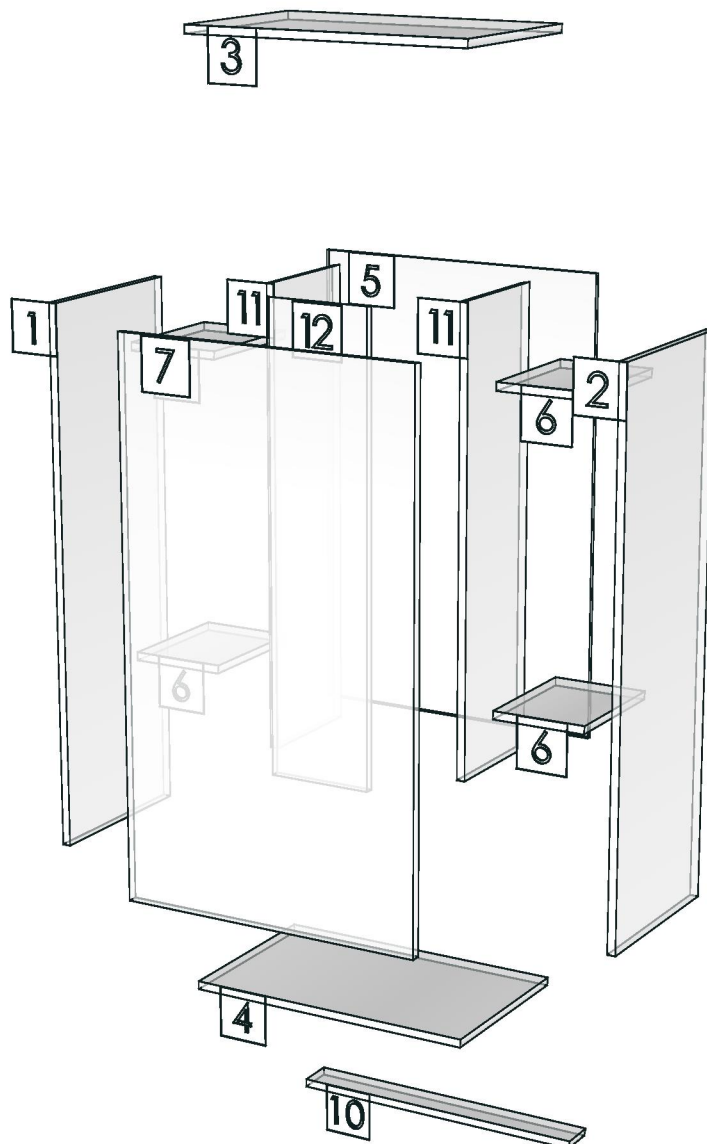

<b>Model</b>	LIFE_CN2_DLMV85LS		
<b>Creator</b>	PASATHORN	<b>.BCP Name</b>	INDEX_C3D_KITCHEN2
<b>Reviewer</b>		<b>Order</b>	I004534
<b>Approves</b>	P.SAWAI	<b>Date</b>	16/10/2025

## **LIFE\_CN2\_DLMV85LS-850X400X1250**

**Colour**

05.38 ML MD692 (SS)\_

-  
-  
-  
-

**Edge**

01.286 1 MD692 \_

-  
-  
-  
-

**R&D REVIEW**

- DWG.Customer
- Work Report
- Function
- สินค้าตรงตัวอย่าง

ผู้ทบทวน P.SAWAI  
25/10/25

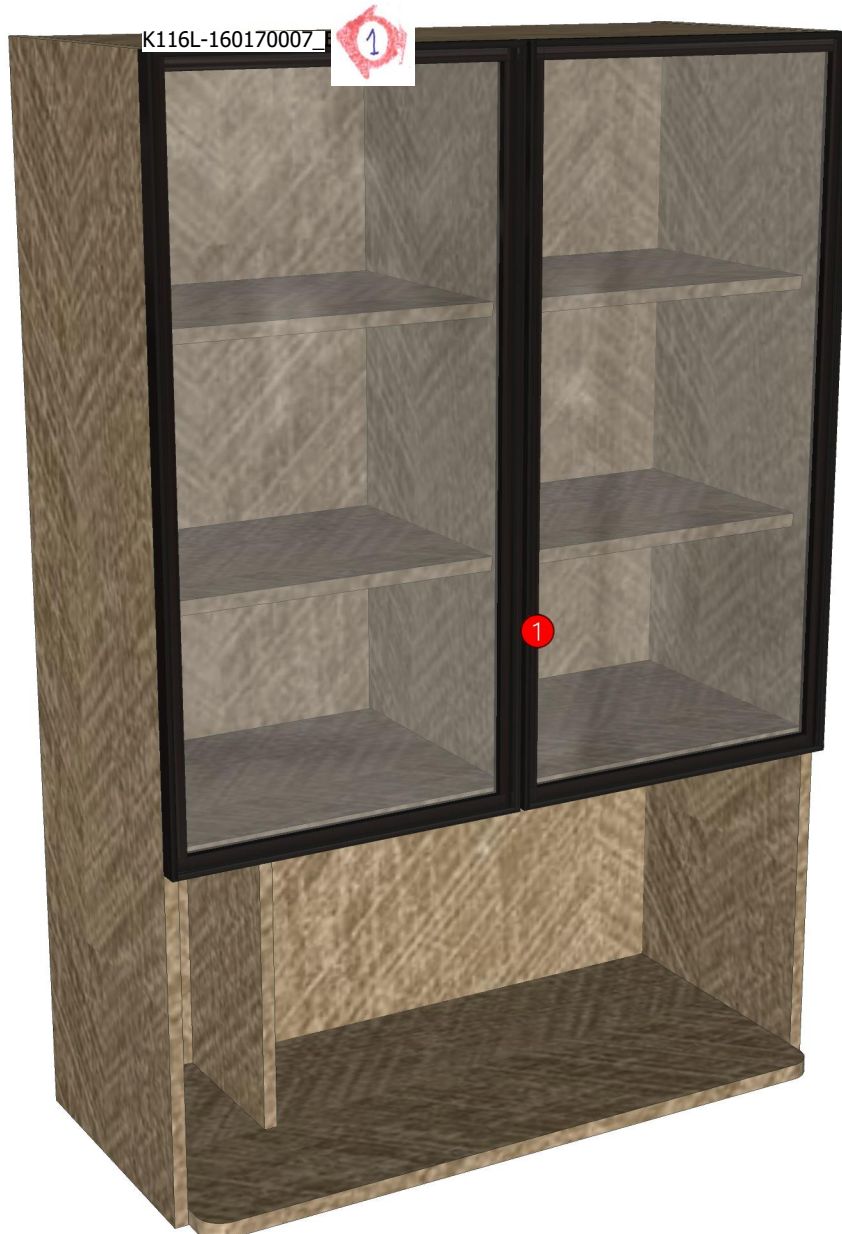

<b>Model</b>	-LIFE_CN2_DLMV85LS		
<b>Creator</b>		<b>.BCP Name</b>	INDEX_C3D_KITCHEN2
<b>Reviewer</b>		<b>Order</b>	I004534
<b>Approves</b>	P. SAWAI	<b>Date</b>	

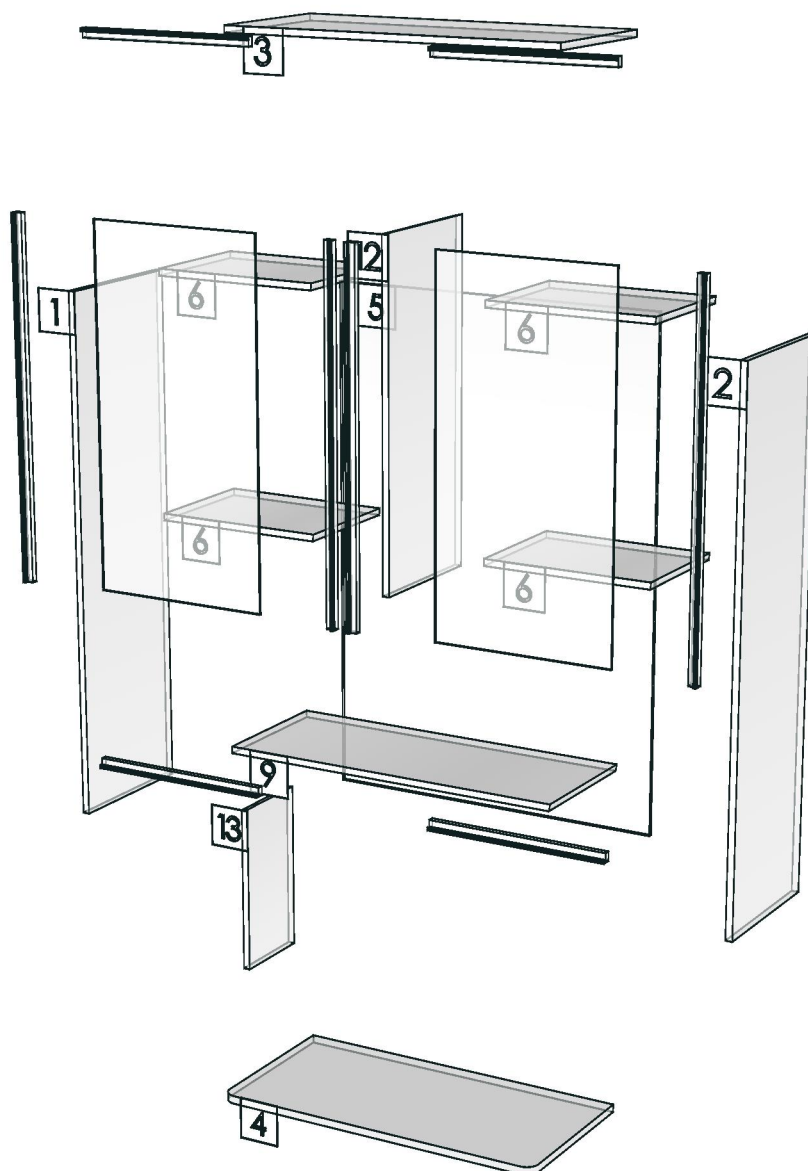

<b>Model</b>	LIFE_CN2_D_PLT600		
<b>Creator</b>	PASATHORN	<b>.BCP Name</b>	INDEX_C3D_KITCHEN2
<b>Reviewer</b>		<b>Order</b>	I004524
<b>Approves</b>	P.SAWAI	<b>Date</b>	16/10/2025

## **LIFE\_CN2\_D\_PLT600-600X9X100**

### **Colour**

05.38 ML MD692 (SS)\_

-

-

-

K100L-160169850

K100R-160169858

K101L-160169866

K101R-160169877

K102L-160169888

K102R-160169897

K103L-160169906

K103R-160169916

K104L-160169926

K105L-160169936

### **Edge**

01.286 1 MD692 \_

-

-

-

-

K113L-160169945

K113R-160169954

K114L-160169963

K114R-160169975

K115L-160169987

K115R-160169997

K116L-160170007

K116R-160170018

K117L-160170029

K118L-160170040

<b>R&amp;D REVIEW</b>	
<input checked="" type="checkbox"/>	DWG.Customer
<input checked="" type="checkbox"/>	Work Report
<input type="checkbox"/>	Function
<input type="checkbox"/>	สินค้าตรงตัวอย่าง
ผู้ทบทวน <u>P.SAWAI</u>	
<u>25/10/25</u>	

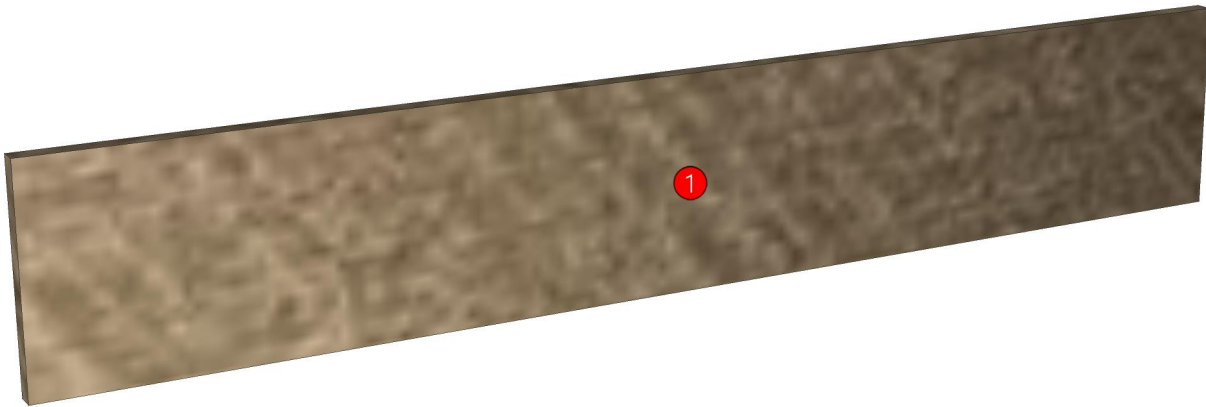

<b>Model</b>	LIFE_CN2_D_PLT600		
<b>Creator</b>	PASATHORN	<b>.BCP Name</b>	INDEX_C3D_KITCHEN2
<b>Reviewer</b>		<b>Order</b>	I004524
<b>Approves</b>	P. SAWAI	<b>Date</b>	16/10/2025

No.	Article No.	Description	Mat	Dimension	Cutting Size	Typepology	Skin
0	LIFE_CN2_D_PLT600	LIFE_CN2_D_PLT600		600x100x9			
	LIFE_CN2_D_PLT600-01	D_PLINT-SP	PB-SP	9x100x600	9X98X598;L2:W2	183000 _STR=05.38 _EDG=MD692-1	2

<b>Model</b>	LIFE_CN2_D_PLT800		
<b>Creator</b>	PASATHORN	<b>.BCP Name</b>	INDEX_C3D_KITCHEN2
<b>Reviewer</b>		<b>Order</b>	I004471
<b>Approves</b>	P.SAWAI	<b>Date</b>	13/10/2025

## **LIFE\_CN2\_D\_PLT800-800X9X100**

### **Colour**

05.38 ML MD692 (SS)\_

-  
-  
-  
-

### **Edge**

01.286 1 MD692 \_

-  
-  
-  
-

<b>R&amp;D REVIEW</b>	
<input checked="" type="checkbox"/>	DWG.Customer
<input checked="" type="checkbox"/>	Work Report
<input type="checkbox"/>	Function
<input type="checkbox"/>	สินค้าตรงตัวอย่าง
ผู้ทบทวน <u>P.SAWAI</u>	
<u>25/10/25</u>	

K102L-160169888  
K102R-160169897  
K103L-160169906  
K103R-160169916

K115L-160169987  
K115R-160169997  
K116L-160170007  
K116R-160170018

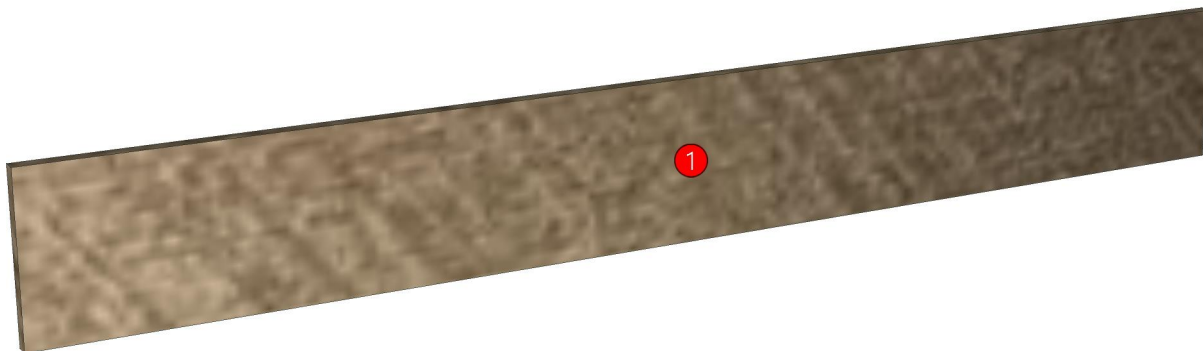

<b>Model</b>	LIFE_CN2_D_PLT800		
<b>Creator</b>	PASATHORN	<b>.BCP Name</b>	INDEX_C3D_KITCHEN2
<b>Reviewer</b>		<b>Order</b>	I004471
<b>Approves</b>	P. SAWAI	<b>Date</b>	13/10/2025

No.	Article No.	Description	Mat	Dimension	Cutting Size	Typepology	Skin
0	LIFE_CN2_D_PLT800	LIFE_CN2_D_PLT800		800x100x9			
	LIFE_CN2_D_PLT800-01	D_PLINT-SP	PB-SP	9x100x800	9X98X798;L2:W2	183000 _STR=05.38 _EDG=MD692-1	2