

Model	LIFE_CN2_DB40LS		
Creator	PASATHORN	.BCP Name	INDEX_C3D_KITCHEN2
Reviewer		Order	I004473
Approves	P.SAWAI	Date	13/10/2025

LIFE_CN2_DB40LS-400X570X913

Colour

05.38 ML MD692 (SS)_
05.30 ML WHITE SAND #VM1012/2610/2610(PEARL)_

Edge

01.286 1 MD692 _
01.47 1 WHITE _

K101L-160169866

K114L-160169963

R&D REVIEW	
<input checked="" type="checkbox"/>	DWG.Customer
<input checked="" type="checkbox"/>	Work Report
<input type="checkbox"/>	Function
<input type="checkbox"/>	สินค้าตรงตัวอย่าง
ผู้ทบทวน <u>P.SAWAI</u>	
<u>25/10/25</u>	

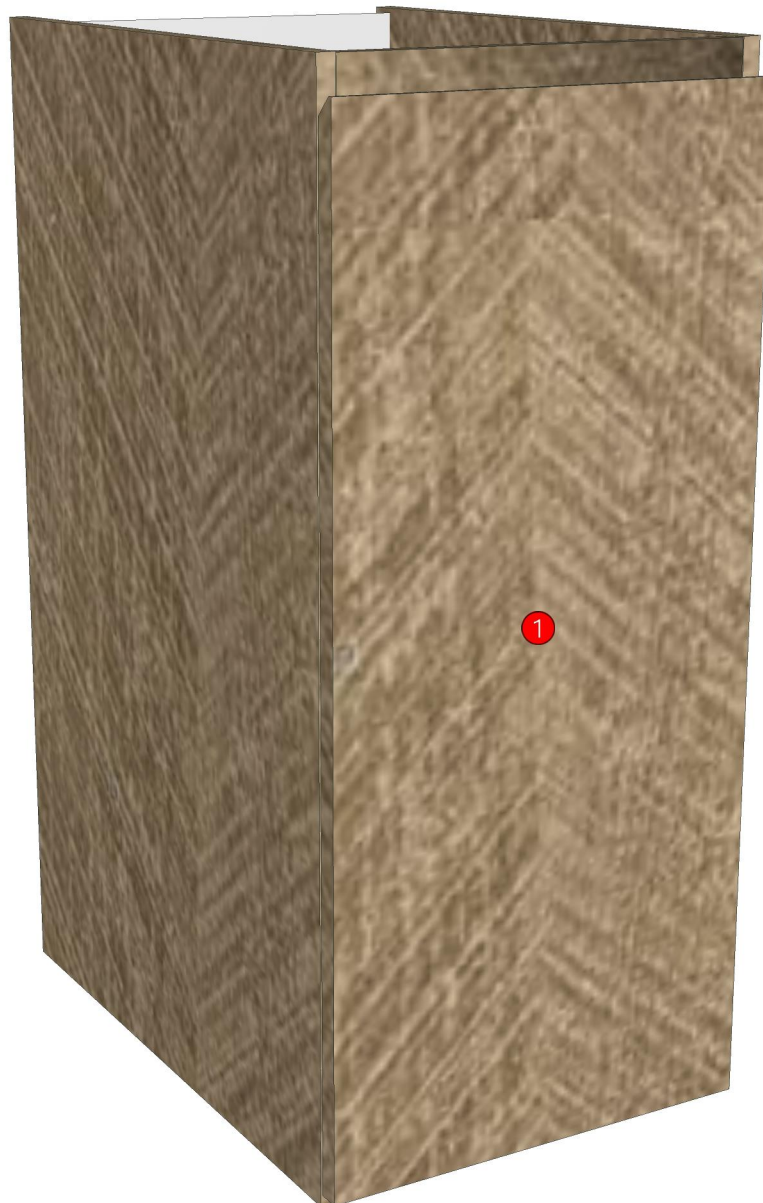

Model	-LIFE_CN2_DB40LS		
Creator		.BCP Name	INDEX_C3D_KITCHEN2
Reviewer		Order	I004473
Approves	P.SAWAI	Date	

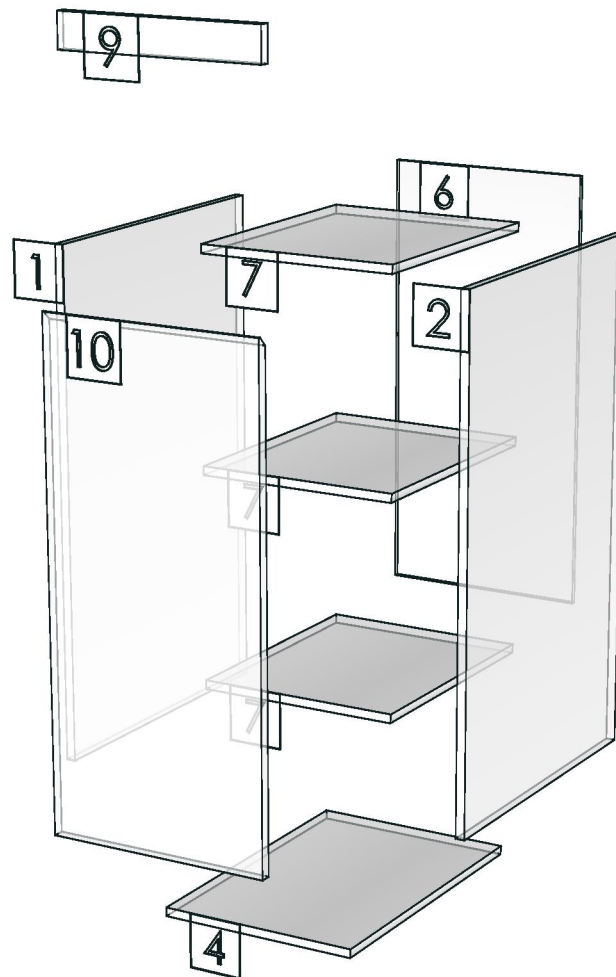

Model	LIFE_CN2_DBO669R		
Creator	PASATHORN	.BCP Name	INDEX_C3D_KITCHEN2
Reviewer		Order	I004481
Approves	P.SAWAI	Date	13/10/2025

LIFE_CN2_DBO669R-669X570X913

Colour

05.38 ML MD692 (SS)_

05.30 ML WHITE SAND #VM1012/2610/2610(PEARL)_

-

-

-

K101L-160169866

Edge

01.286 1 MD692 _

01.47 1 WHITE _

-

-

-

K114L-160169963

R&D REVIEW	
<input checked="" type="checkbox"/>	DWG.Customer
<input checked="" type="checkbox"/>	Work Report
<input type="checkbox"/>	Function
<input type="checkbox"/>	สินค้าตรงตัวอย่าง
ผู้ทบทวน <u>P.SAWAI</u>	
<u>25/10/25</u>	

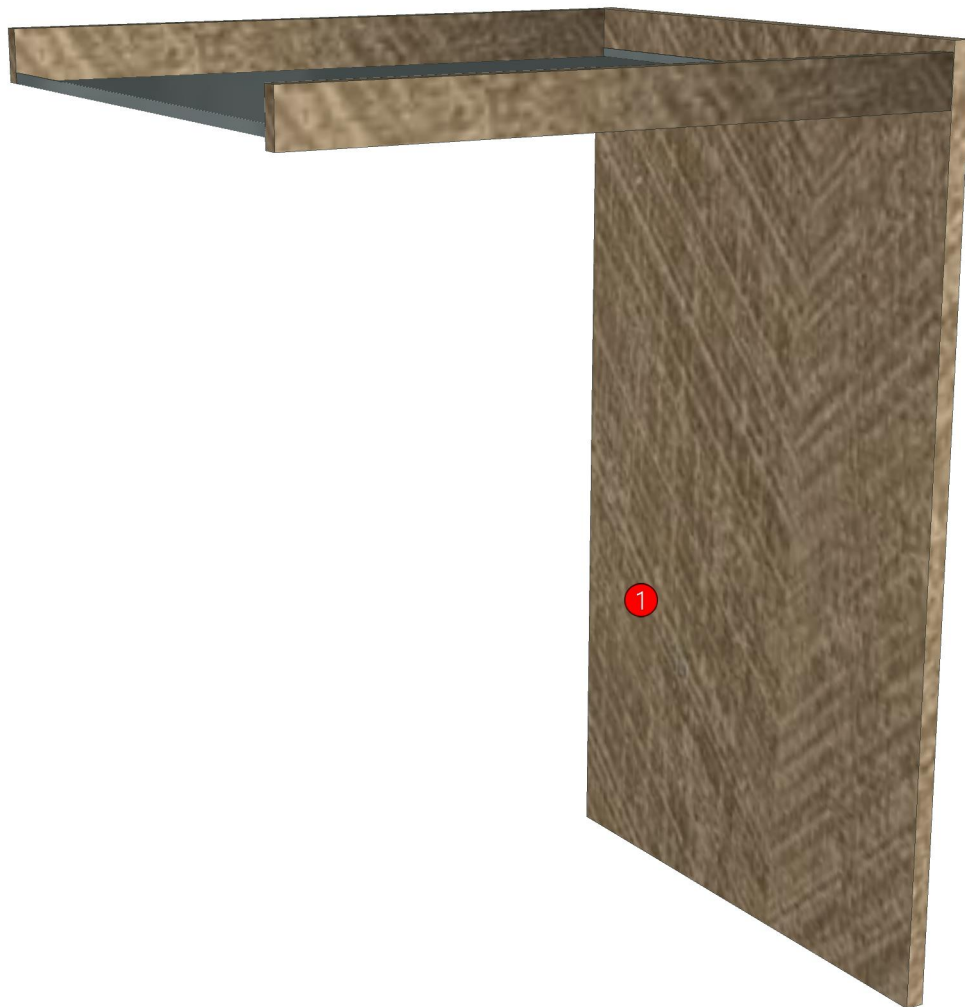

Model	-LIFE_CN2_DBO669R		
Creator		.BCP Name	INDEX_C3D_KITCHEN2
Reviewer		Order	I004481
Approves	P. SAWAI	Date	

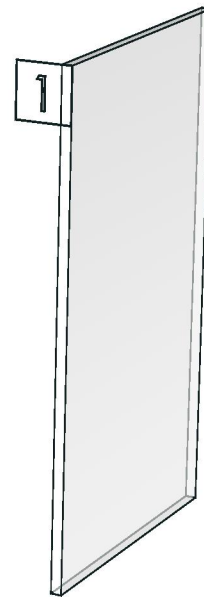
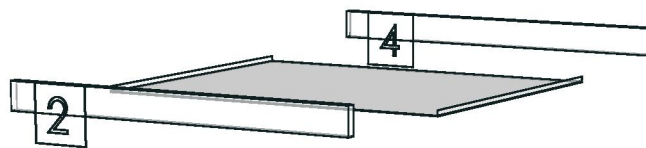

Model	LIFE_CN2_DBS581LGR		
Creator	PASATHORN	.BCP Name	INDEX_C3D_KITCHEN2
Reviewer		Order	I004487
Approves		Date	13/10/2025

LIFE_CN2_DBS581LGR-581X570X913

Colour

05.38 ML MD692 (SS)_

05.30 ML WHITE SAND #VM1012/2610/2610(PEARL)_

-

-

-

K101L-160169866

Edge

01.286 1 MD692 _

01.465 0.6 CHARLOTTE MD692 (A1519TH00)_

-

-

-

K114L-160169963_E



R&D REVIEW	
<input checked="" type="checkbox"/>	DWG.Customer
<input checked="" type="checkbox"/>	Work Report
<input type="checkbox"/>	Function
<input type="checkbox"/>	สินค้าตรงตัวอย่าง
ผู้ทบทวน _____	

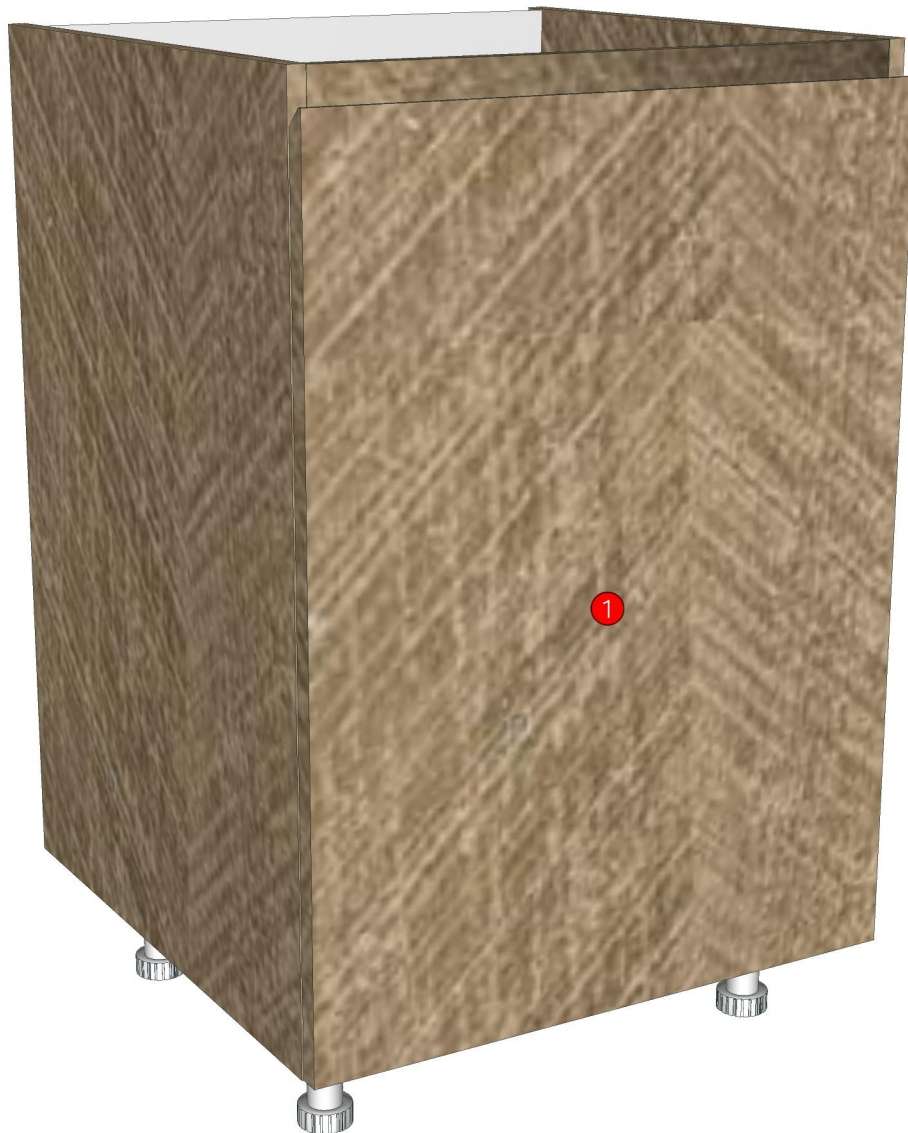

Model	-LIFE_CN2_DBS581LGR		
Creator		.BCP Name	INDEX_C3D_KITCHEN2
Reviewer		Order	I004487
Approves		Date	

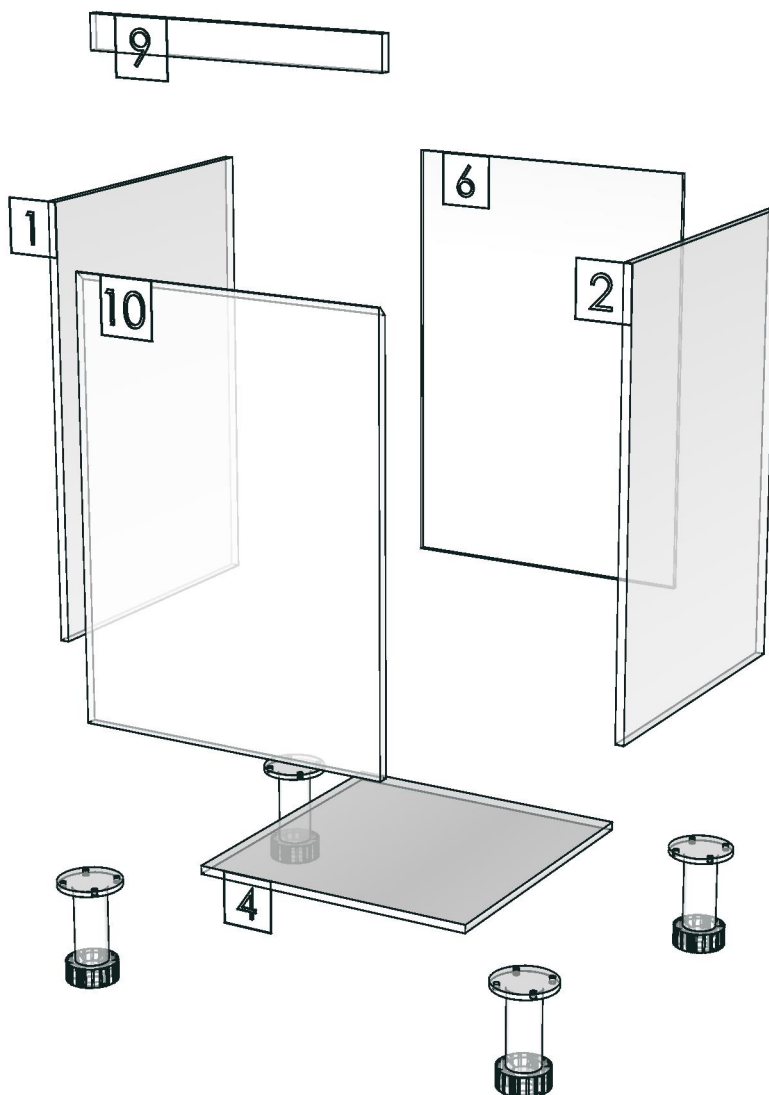

Model	LIFE_CN2_DDM5009		
Creator	PASATHORN	.BCP Name	INDEX_C3D_KITCHEN2
Reviewer		Order	I004495
Approves	P.SAWAI	Date	13/10/2025

LIFE_CN2_DDM5009-500X9X600

Colour

05.38 ML MD692 (SS)_

-
-
-
-

Edge

01.286 1 MD692 _

-
-
-
-

K101L-160169866

K101R-160169877

K114L-160169963_F

K114R-160169975_I

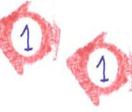

R&D REVIEW	
<input checked="" type="checkbox"/>	DWG.Customer
<input checked="" type="checkbox"/>	Work Report
<input type="checkbox"/>	Function
<input type="checkbox"/>	สินค้าตรงตัวอย่าง
ผู้ทบทวน <u>P.SAWAI</u>	
<u>25/10/25</u>	

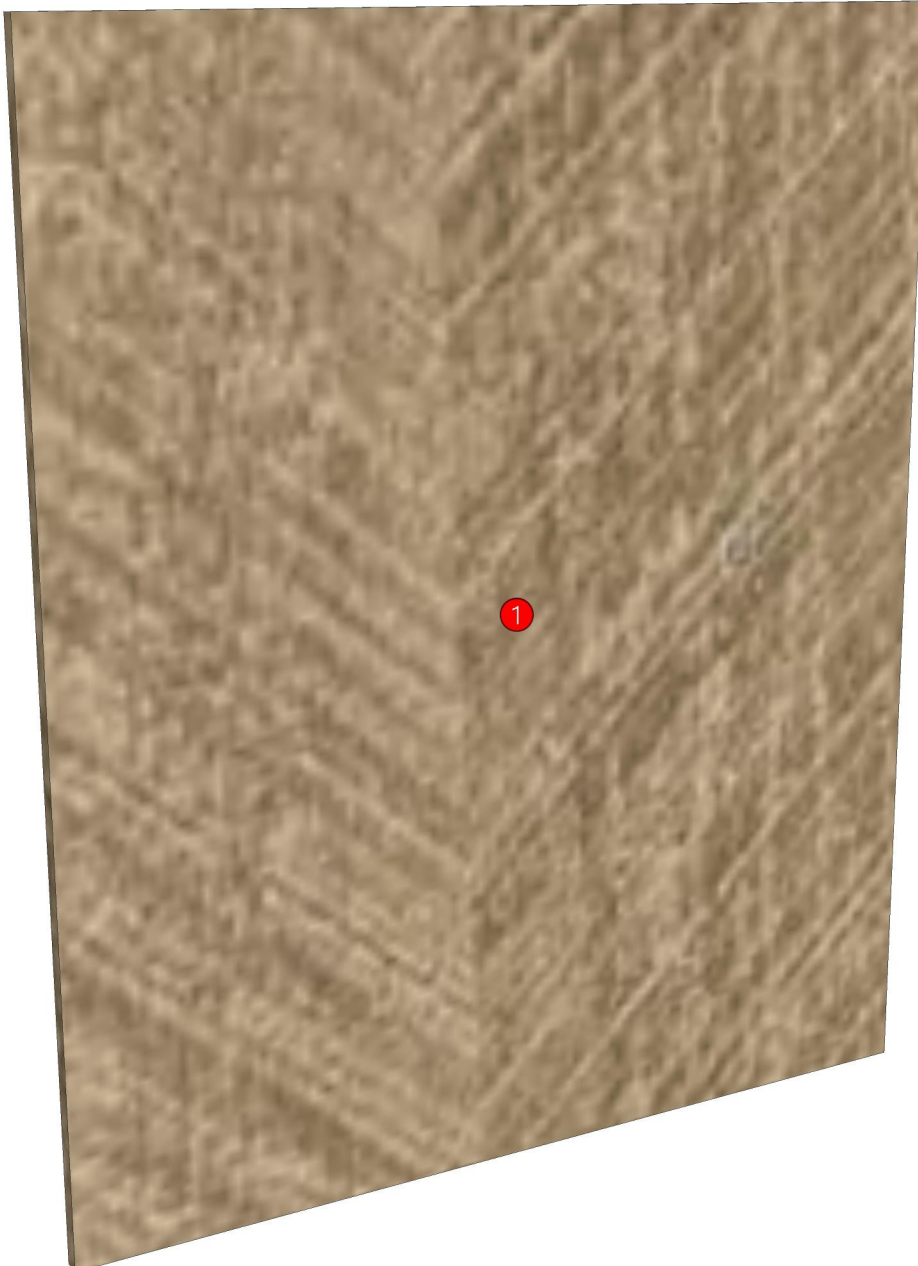

Model	LIFE_CN2_DDM5009		
Creator	PASATHORN	.BCP Name	INDEX_C3D_KITCHEN2
Reviewer		Order	I004495
Approves	P. SAWAI	Date	13/10/2025

No.	Article No.	Description	Mat	Dimension	Cutting Size	Typepology	Skin
0	LIFE_CN2_DDM5009	LIFE_CN2_DDM5009		500x600x9			
	LIFE_CN2_DDM5009-01	DDM	PB-SP	9x500x600	9X499X598;L1:W2	186000 _STR=05.38 _EDG=MD692-1	2

Model	LIFE_CN2_DDM700		
Creator	PASATHORN	.BCP Name	INDEX_C3D_KITCHEN2
Reviewer		Order	I004494
Approves	P.SAWAI	Date	13/10/2025

LIFE_CN2_DDM700-700X16X150

Colour

05.38 ML MD692 (SS)_

-
-
-
-

K101L-160169866

K101R-160169877

K103L-160169906

K103R-160169916

K104L-160169926

Edge

01.286 1 MD692 _

-
-
-
-

K114L-160169963

K114R-160169975

K116L-160170007

K116R-160170018

K117L-160170029

R&D REVIEW	
<input checked="" type="checkbox"/>	DWG.Customer
<input checked="" type="checkbox"/>	Work Report
<input type="checkbox"/>	Function
<input type="checkbox"/>	สินค้าตรงตัวอย่าง
ผู้ทบทวน <u>P.SAWAI</u>	
<u>25/10/25</u>	

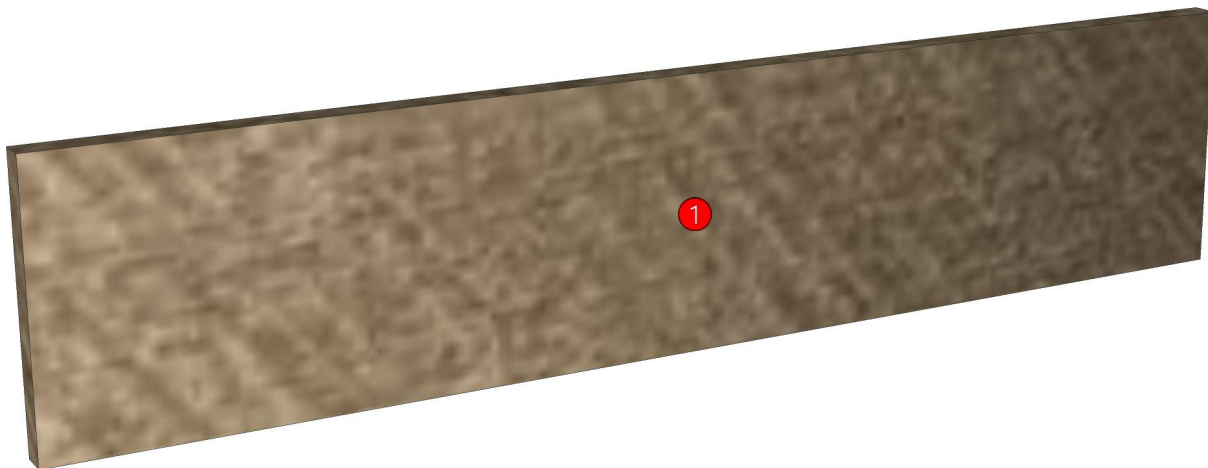

Model	LIFE_CN2_DDM700		
Creator	PASATHORN	.BCP Name	INDEX_C3D_KITCHEN2
Reviewer		Order	I004494
Approves	P. SAWAI	Date	13/10/2025

No.	Article No.	Description	Mat	Dimension	Cutting Size	Typepology	Skin
0	LIFE_CN2_DDM700	LIFE_CN2_DDM700		700x150x16			
	LIFE_CN2_DDM700-01	DDM-SP	PB-SP	16x150x700	16X148X699;L2:W1	183000 _STR=05.38 _EDG=MD692-1	2

Model	LIFE_CN2_DFBS		
Creator	PASATHORN	.BCP Name	INDEX_C3D_KITCHEN2
Reviewer		Order	I004504
Approves	P.SAWAI	Date	13/10/2025

LIFE_CN2_DFBS-150X16X913

Colour

05.38 ML MD692 (SS)_

-
-
-
-

Edge

01.286 1 MD692 _

-
-
-
-

K101L-160169866

K114L-160169963

K101R-160169877

K114R-160169975

R&D REVIEW	
<input checked="" type="checkbox"/>	DWG.Customer
<input checked="" type="checkbox"/>	Work Report
<input type="checkbox"/>	Function
<input type="checkbox"/>	สินค้าตรงตัวอย่าง
ผู้ทบทวน <u>P.SAWAI</u>	
<u>25/10/25</u>	



Model	LIFE_CN2_DFBS		
Creator	PASATHORN	.BCP Name	INDEX_C3D_KITCHEN2
Reviewer		Order	I004504
Approves	P. SAWAI	Date	13/10/2025

No.	Article No.	Description	Mat	Dimension	Cutting Size	Typepology	Skin
0	LIFE_CN2_DFBS	LIFE_CN2_DFBS		150x913x16			
	LIFE_CN2_DFBS-01	Front DF-SP	PB-SP	16x150x913	16X149X911;L1:W2	186000 _STR=05.38 _EDG=MD692-1	2

Model	LIFE_CN2_DFL		
Creator	PASATHORN	.BCP Name	INDEX_C3D_KITCHEN2
Reviewer		Order	I004505
Approves	P.SAWAI	Date	13/10/2025

LIFE_CN2_DFL-150X16X900

Colour

05.38 ML MD692 (SS)_

-
-
-
-

K101L-160169866

K101R-160169877

K103L-160169906

K103R-160169916

K104L-160169926

Edge

01.286 1 MD692 _

-
-
-
-

R&D REVIEW

- DWG.Customer
- Work Report
- Function
- สินค้าตรงตัวอย่าง

ผู้ทบทวน P.SAWAI
25/10/25

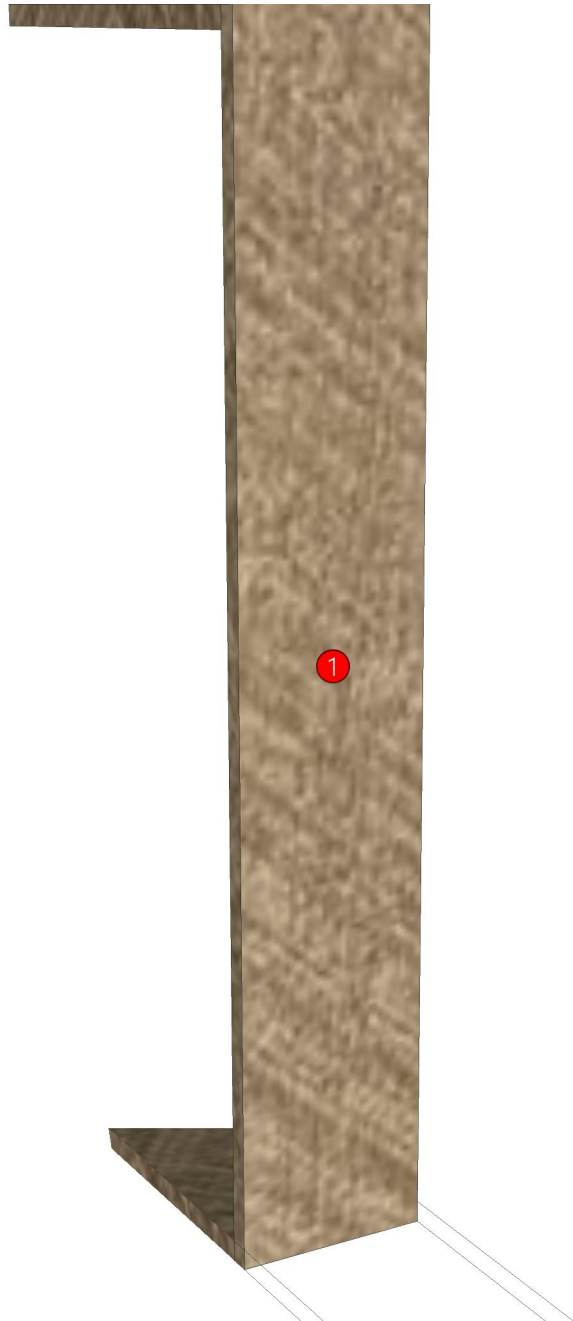

Model	-LIFE_CN2_DFL		
Creator		.BCP Name	INDEX_C3D_KITCHEN2
Reviewer		Order	I004505
Approves	P. SAWAI	Date	

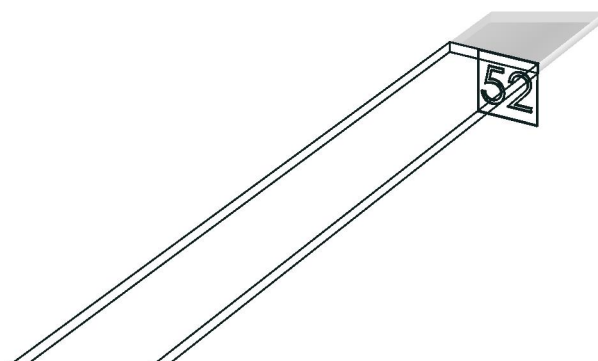

Model	LIFE_CN2_DF_CL1800		
Creator	PASATHORN	.BCP Name	INDEX_C3D_KITCHEN2
Reviewer		Order	I004502
Approves	P.SAWAI	Date	13/10/2025

LIFE_CN2_DF_CL1800-1800X16X155

Colour

05.38 ML MD692 (SS)_

-
-
-
-

Edge

01.286 1 MD692 _

-
-
-
-

K101L-160169866

K101R-160169877

R&D REVIEW

- DWG.Customer
- Work Report
- Function
- สินค้าตรงตัวอย่าง

ผู้ทบทวน P.SAWAI
25/10/25

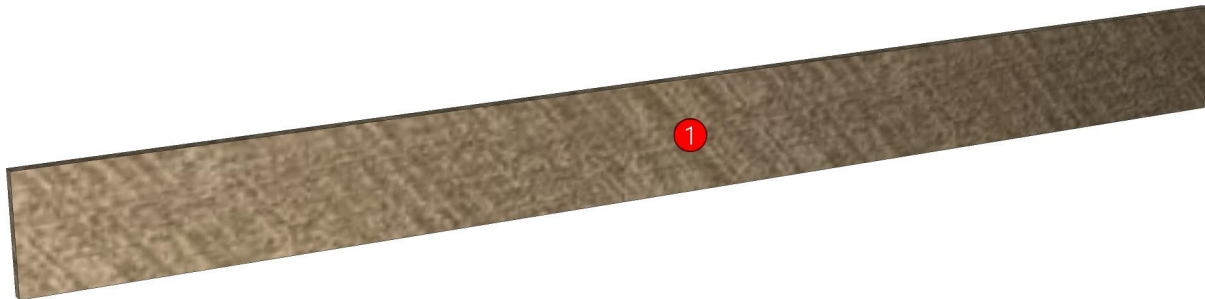

Model	LIFE_CN2_DF_CL1800		
Creator	PASATHORN	.BCP Name	INDEX_C3D_KITCHEN2
Reviewer		Order	I004502
Approves	P. SAWAI	Date	13/10/2025

No.	Article No.	Description	Mat	Dimension	Cutting Size	Typepology	Skin
0	LIFE_CN2_DF_CL1800	LIFE_CN2_DF_CL1800		1800x155x16			
	LIFE_CN2_DF_CL1800-01	DF_CL-SP	PB-SP	16x155x1800	16X154X1800;L1:W0	183000 _STR=05.38 _EDG=MD692-1	2

Model	LIFE_CN2_DL40L		
Creator	PASATHORN	.BCP Name	INDEX_C3D_KITCHEN2
Reviewer		Order	I004507
Approves	P.SAWAI	Date	13/10/2025

LIFE_CN2_DL40L-400X350X900

Colour

05.38 ML MD692 (SS)_

05.30 ML WHITE SAND #VM1012/2610/2610(PEARL)_

-

-

-

K101L-160169866

Edge

01.286 1 MD692 _

01.47 1 WHITE _

-

-

-

R&D REVIEW	
<input checked="" type="checkbox"/>	DWG.Customer
<input checked="" type="checkbox"/>	Work Report
<input type="checkbox"/>	Function
<input type="checkbox"/>	สินค้าตรงตัวอย่าง
ผู้ทบทวน <u>P.SAWAI</u>	
<u>13/10/2025</u>	

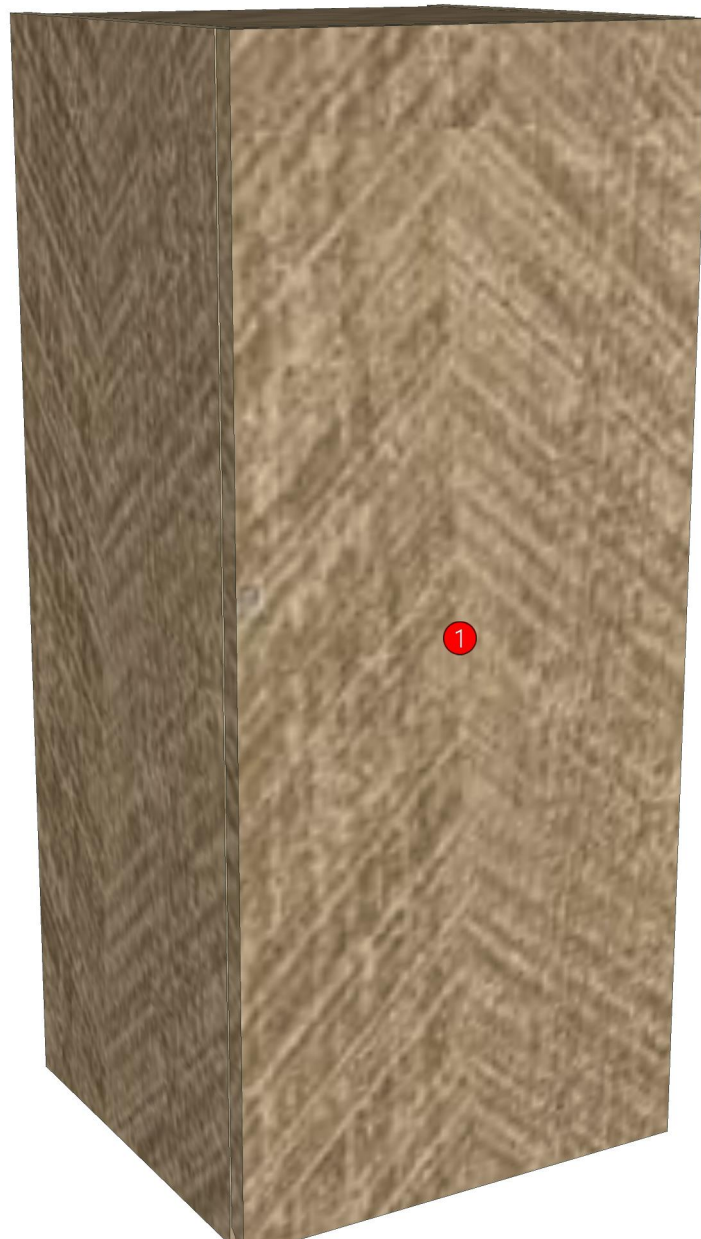

Model	-LIFE_CN2_DL40L		
Creator		.BCP Name	INDEX_C3D_KITCHEN2
Reviewer		Order	I004507
Approves	P.SAWAI	Date	

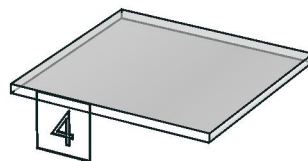
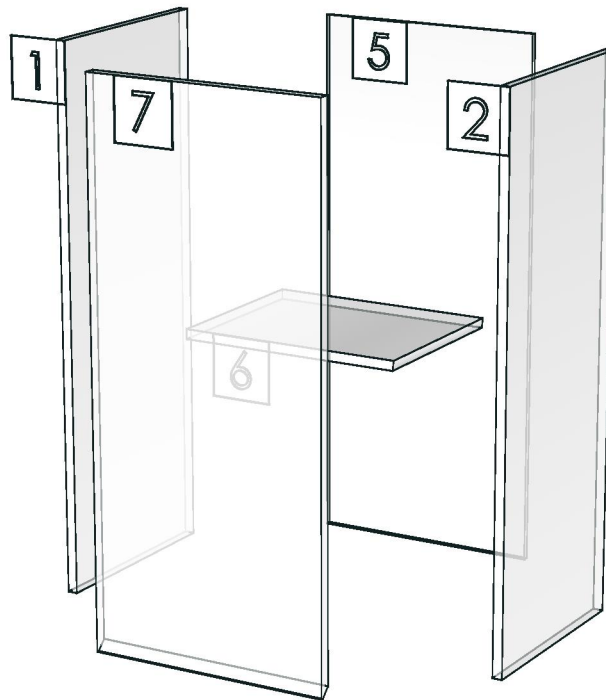
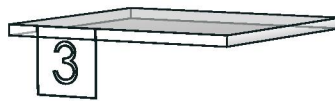

Model	LIFE_CN2_DL60HR		
Creator	PASATHORN	.BCP Name	INDEX_C3D_KITCHEN2
Reviewer		Order	I004511
Approves	P.SAWAI	Date	13/10/2025

LIFE_CN2_DL60HR-600X350X860

Colour

05.38 ML MD692 (SS)_

05.30 ML WHITE SAND #VM1012/2610/2610(PEARL)_

-

-

-

K101L-160169866

Edge

01.286 1 MD692 _

01.47 1 WHITE _

-

-

-

K103L-160169906

K104L-160169926

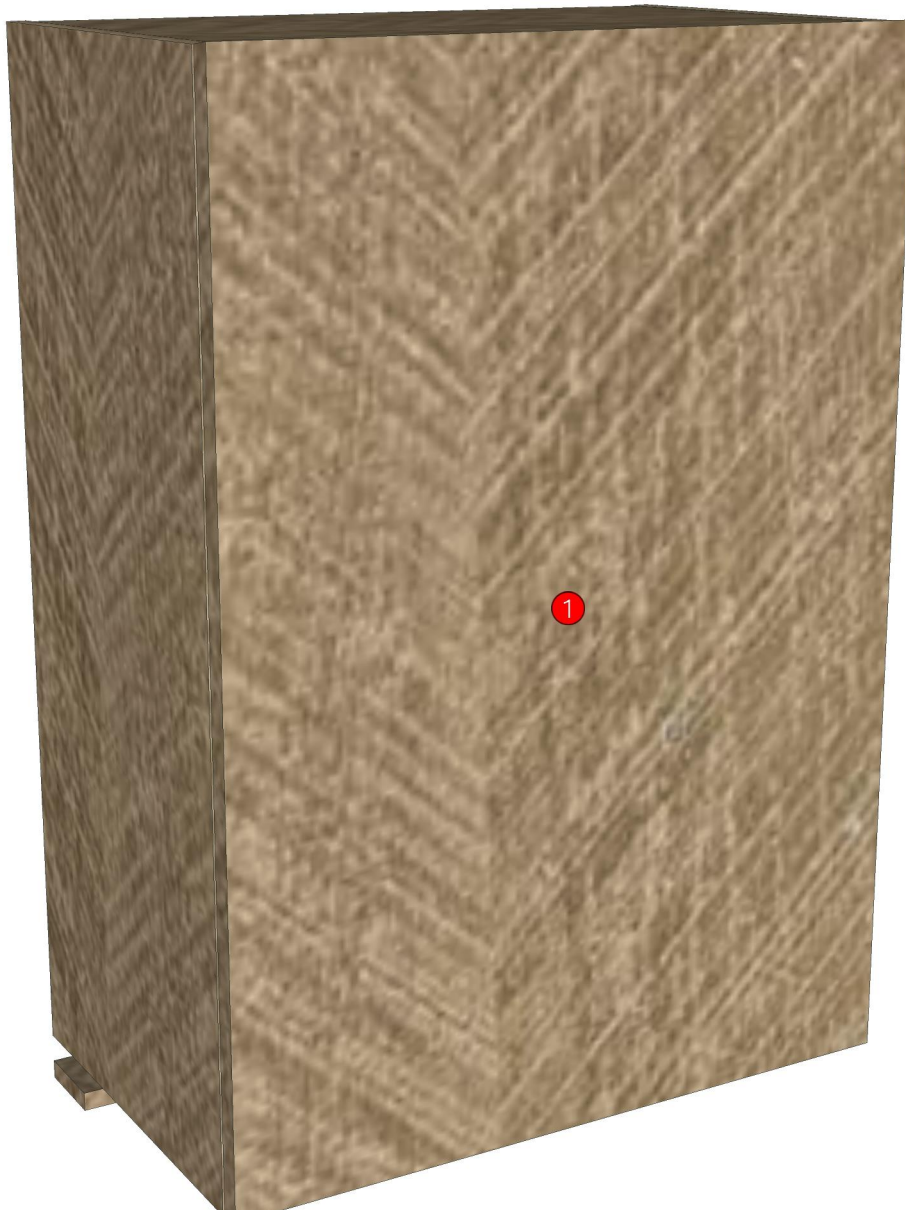

R&D REVIEW	
<input checked="" type="checkbox"/>	DWG.Customer
<input checked="" type="checkbox"/>	Work Report
<input type="checkbox"/>	Function
<input type="checkbox"/>	สินค้าตรงตัวอย่าง
ผู้ทบทวน <u>P.SAWAI</u>	
<u>25/10/25</u>	

Model	-LIFE_CN2_DL60HR		
Creator		.BCP Name	INDEX_C3D_KITCHEN2
Reviewer		Order	I004511
Approves	P. SAWAI	Date	

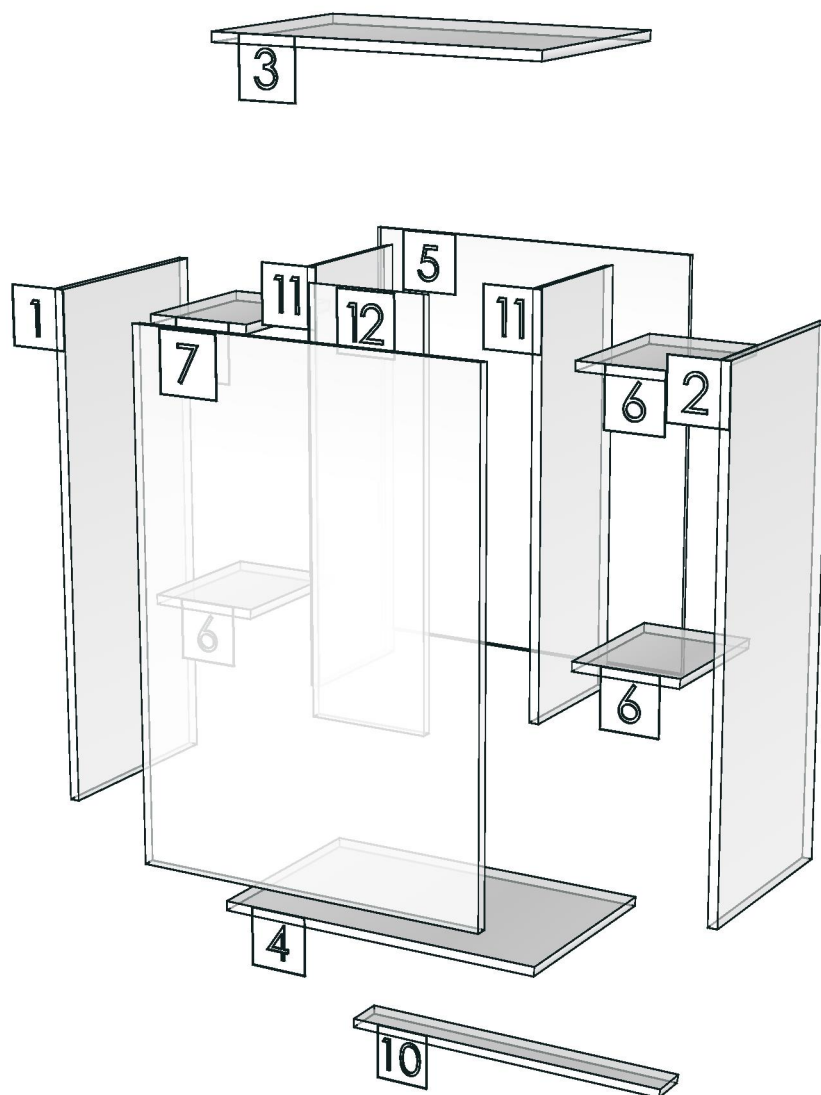

Model	LIFE_CN2_DLMV60L		
Creator	PASATHORN	.BCP Name	INDEX_C3D_KITCHEN2
Reviewer		Order	I004513
Approves	P.SAWAI	Date	13/10/2025

LIFE_CN2_DLMV60L-600X400X1050

Colour

05.38 ML MD692 (SS)_

05.30 ML WHITE SAND #VM1012/2610/2610(PEARL)_

-

-

-

K101L-160169866

Edge

01.286 1 MD692 _

01.47 1 WHITE _

-

-

-

R&D REVIEW	
<input checked="" type="checkbox"/>	DWG.Customer
<input checked="" type="checkbox"/>	Work Report
<input type="checkbox"/>	Function
<input type="checkbox"/>	สินค้าตรงตัวอย่าง
ผู้ทบทวน <u>P.SAWAI</u>	
<u>25/10/25</u>	

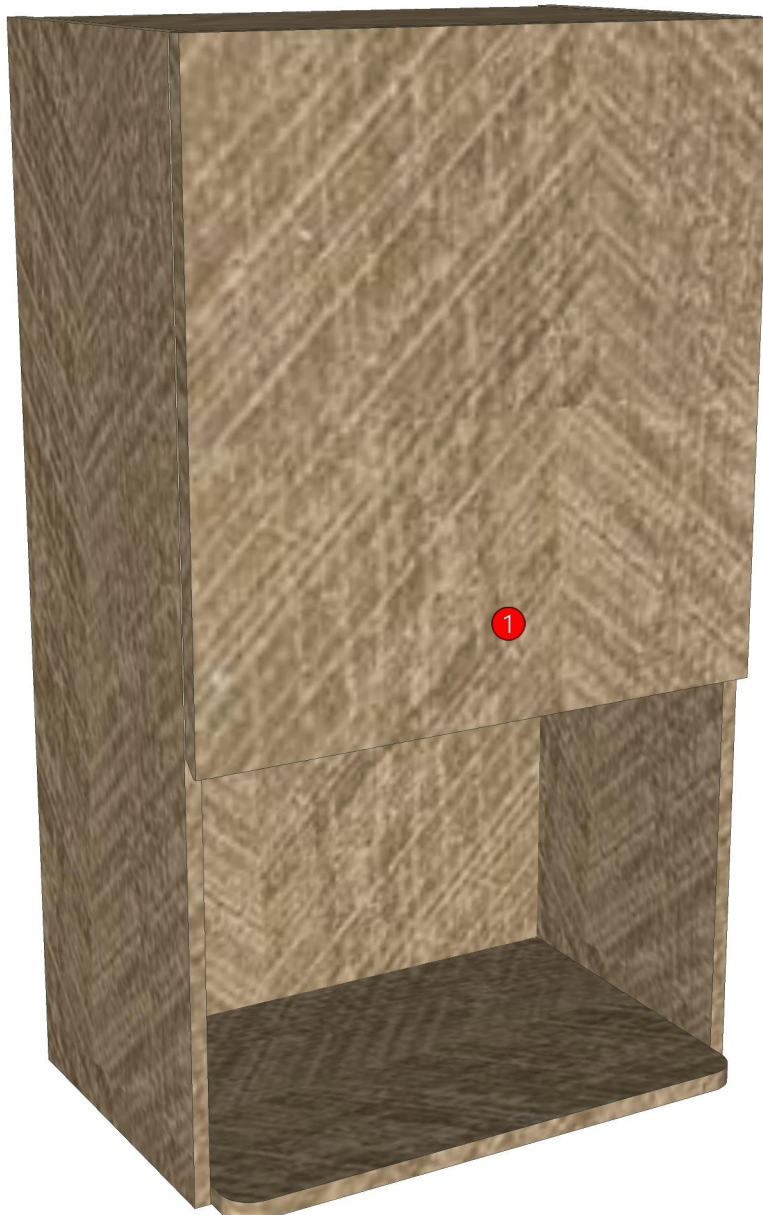

Model	-LIFE_CN2_DLMV60L		
Creator		.BCP Name	INDEX_C3D_KITCHEN2
Reviewer		Order	I004513
Approves	P.SAWAI	Date	

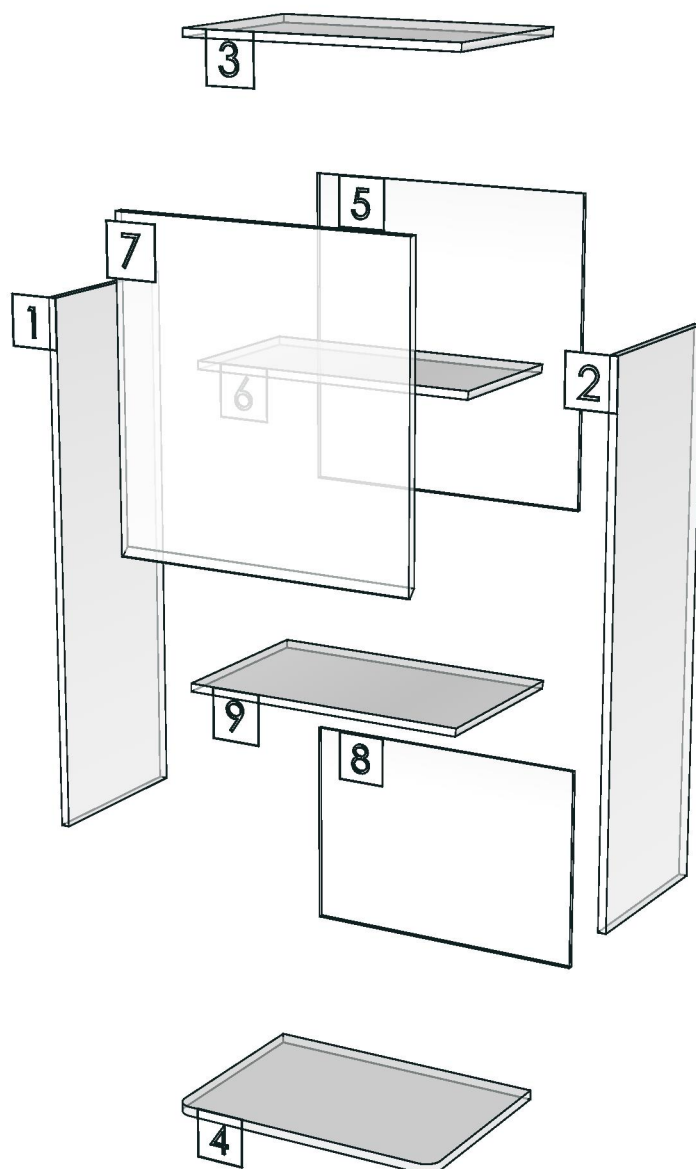

Model	LIFE_CN2_D_PLT581		
Creator	PASATHORN	.BCP Name	INDEX_C3D_KITCHEN2
Reviewer		Order	I004468
Approves	P.SAWAI	Date	13/10/2025

LIFE_CN2_D_PLT581-581X9X100

Colour

05.38 ML MD692 (SS)_

-
-
-
-

K101L-160169866

K101R-160169877

Edge

01.286 1 MD692 _

-
-
-
-

K114L-160169963

K114R-160169975

R&D REVIEW	
<input checked="" type="checkbox"/>	DWG.Customer
<input checked="" type="checkbox"/>	Work Report
<input type="checkbox"/>	Function
<input type="checkbox"/>	สินค้าตรงตัวอย่าง
ผู้ทบทวน <u>P.SAWAI</u>	
<u>25/10/25</u>	

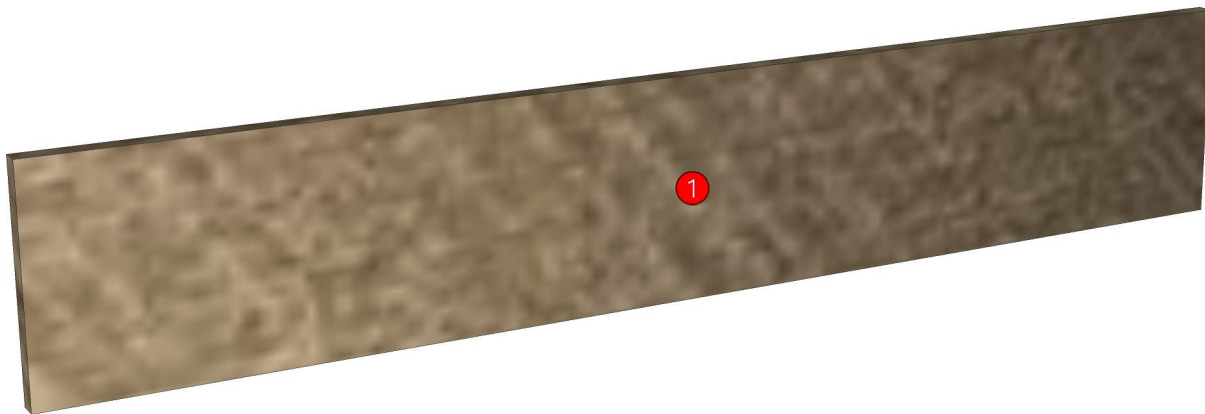

Model	LIFE_CN2_D_PLT581		
Creator	PASATHORN	.BCP Name	INDEX_C3D_KITCHEN2
Reviewer		Order	I004468
Approves	P. SAWAI	Date	13/10/2025

No.	Article No.	Description	Mat	Dimension	Cutting Size	Typepology	Skin
0	LIFE_CN2_D_PLT581	LIFE_CN2_D_PLT581		581x100x9			
	LIFE_CN2_D_PLT581-01	D_PLINT-SP	PB-SP	9x100x581	9X98X579;L2:W2	183000 _STR=05.38 _EDG=MD692-1	2

Model	LIFE_CN2_D_PLT600		
Creator	PASATHORN	.BCP Name	INDEX_C3D_KITCHEN2
Reviewer		Order	I004524
Approves	P.SAWAI	Date	16/10/2025

LIFE_CN2_D_PLT600-600X9X100

Colour

05.38 ML MD692 (SS)_

-

-

-

K100L-160169850

K100R-160169858

K101L-160169866

K101R-160169877

K102L-160169888

K102R-160169897

K103L-160169906

K103R-160169916

K104L-160169926

K105L-160169936

Edge

01.286 1 MD692 _

-

-

-

-

K113L-160169945

K113R-160169954

K114L-160169963

K114R-160169975

K115L-160169987

K115R-160169997

K116L-160170007

K116R-160170018

K117L-160170029

K118L-160170040

R&D REVIEW	
<input checked="" type="checkbox"/>	DWG.Customer
<input checked="" type="checkbox"/>	Work Report
<input type="checkbox"/>	Function
<input type="checkbox"/>	สินค้าตรงตัวอย่าง
ผู้ทบทวน <u>P.SAWAI</u>	
<u>25/10/25</u>	

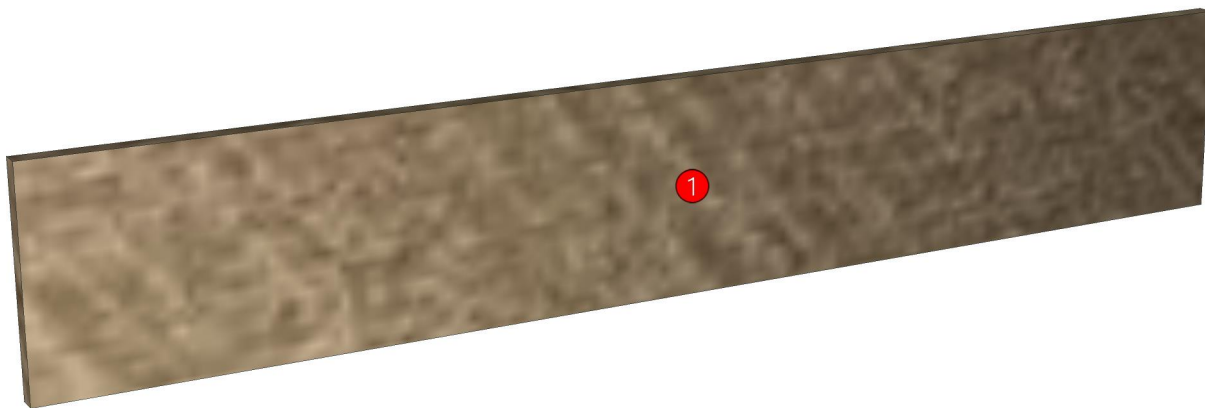

Model	LIFE_CN2_D_PLT600		
Creator	PASATHORN	.BCP Name	INDEX_C3D_KITCHEN2
Reviewer		Order	I004524
Approves	P. SAWAI	Date	16/10/2025

No.	Article No.	Description	Mat	Dimension	Cutting Size	Typepology	Skin
0	LIFE_CN2_D_PLT600	LIFE_CN2_D_PLT600		600x100x9			
	LIFE_CN2_D_PLT600-01	D_PLINT-SP	PB-SP	9x100x600	9X98X598;L2:W2	183000 _STR=05.38 _EDG=MD692-1	2