

Model	LIFE_CN2_DBO665L		
Creator	PASATHORN	.BCP Name	INDEX_C3D_KITCHEN2
Reviewer		Order	I004522
Approves	P.SAWAI	Date	14/10/2025

LIFE_CN2_DBO665L-665X570X913

Colour

05.38 ML MD692 (SS)_

05.30 ML WHITE SAND #VM1012/2610/2610(PEARL)_

-

-

-

K100R-160169858

Edge

01.286 1 MD692 _

01.47 1 WHITE _

-

-

-

K113R-160169954

R&D REVIEW	
<input checked="" type="checkbox"/>	DWG.Customer
<input checked="" type="checkbox"/>	Work Report
<input type="checkbox"/>	Function
<input type="checkbox"/>	สินค้าตรงตัวอย่าง
ผู้ทบทวน <u>P.SAWAI</u>	
<u>14/10/25</u>	

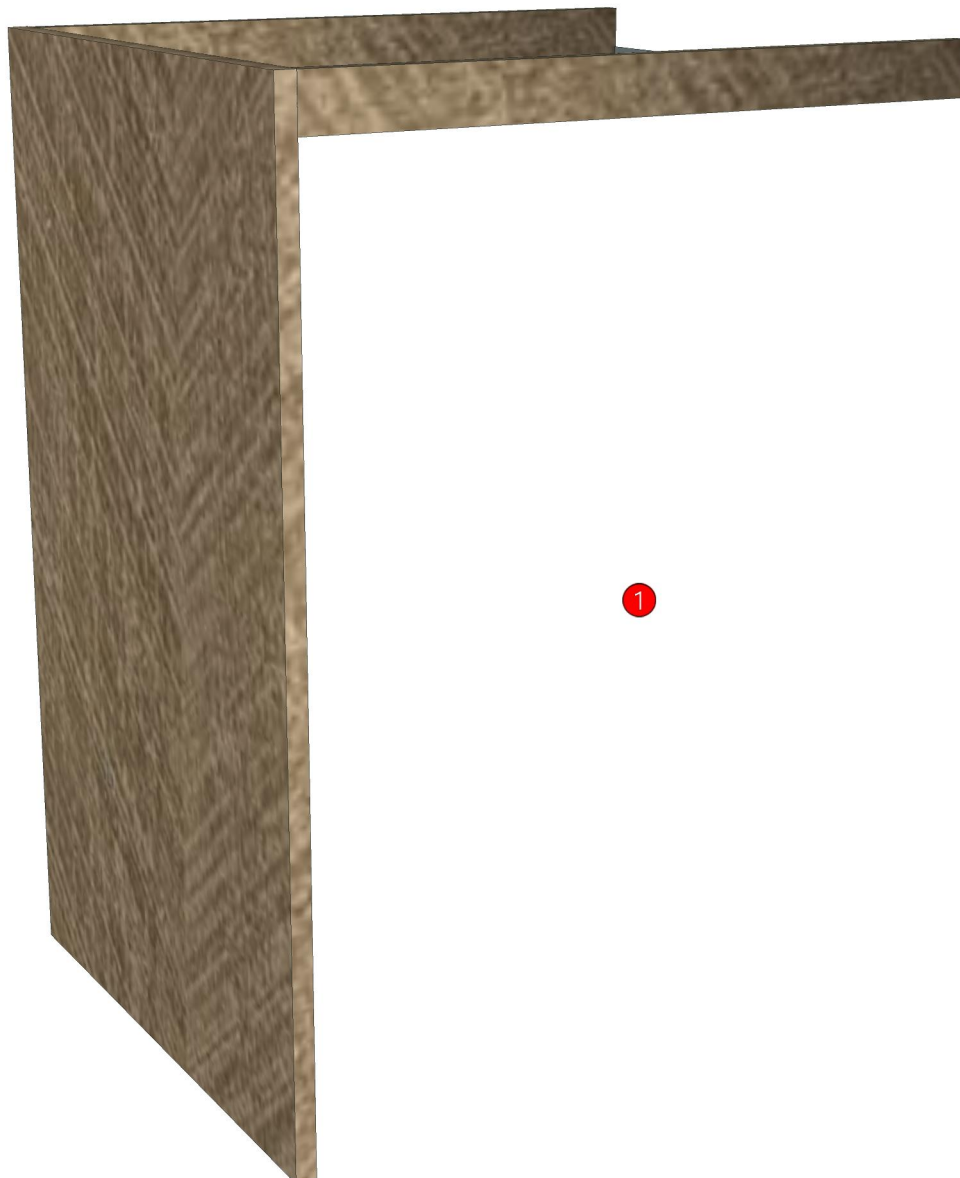

Model	-LIFE_CN2_DBO665L		
Creator		.BCP Name	INDEX_C3D_KITCHEN2
Reviewer		Order	I004522
Approves	P. SAWAI	Date	

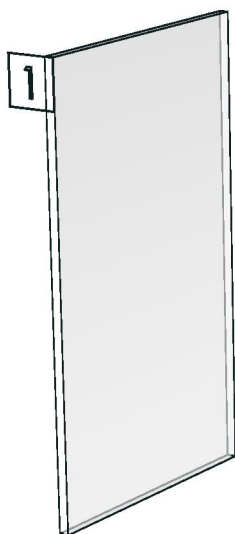
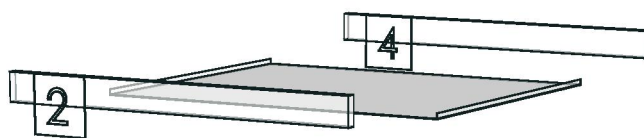

Model	LIFE_CN2_DBS731RGL		
Creator	PASATHORN	.BCP Name	INDEX_C3D_KITCHEN2
Reviewer		Order	I004492
Approves		Date	13/10/2025

LIFE_CN2_DBS731RGL-731X570X913

Colour

05.38 ML MD692 (SS)_

05.30 ML WHITE SAND #VM1012/2610/2610(PEARL)_

-

-

-

K100R-160169858

Edge

01.286 1 MD692 _

01.465 0.6 CHARLOTTE MD692 (A1519TH00)_

-

-



K113R-160169954_ED

R&D REVIEW	
<input checked="" type="checkbox"/>	DWG.Customer
<input checked="" type="checkbox"/>	Work Report
<input type="checkbox"/>	Function
<input type="checkbox"/>	สินค้าตรงตัวอย่าง
ผู้ทบทวน _____	

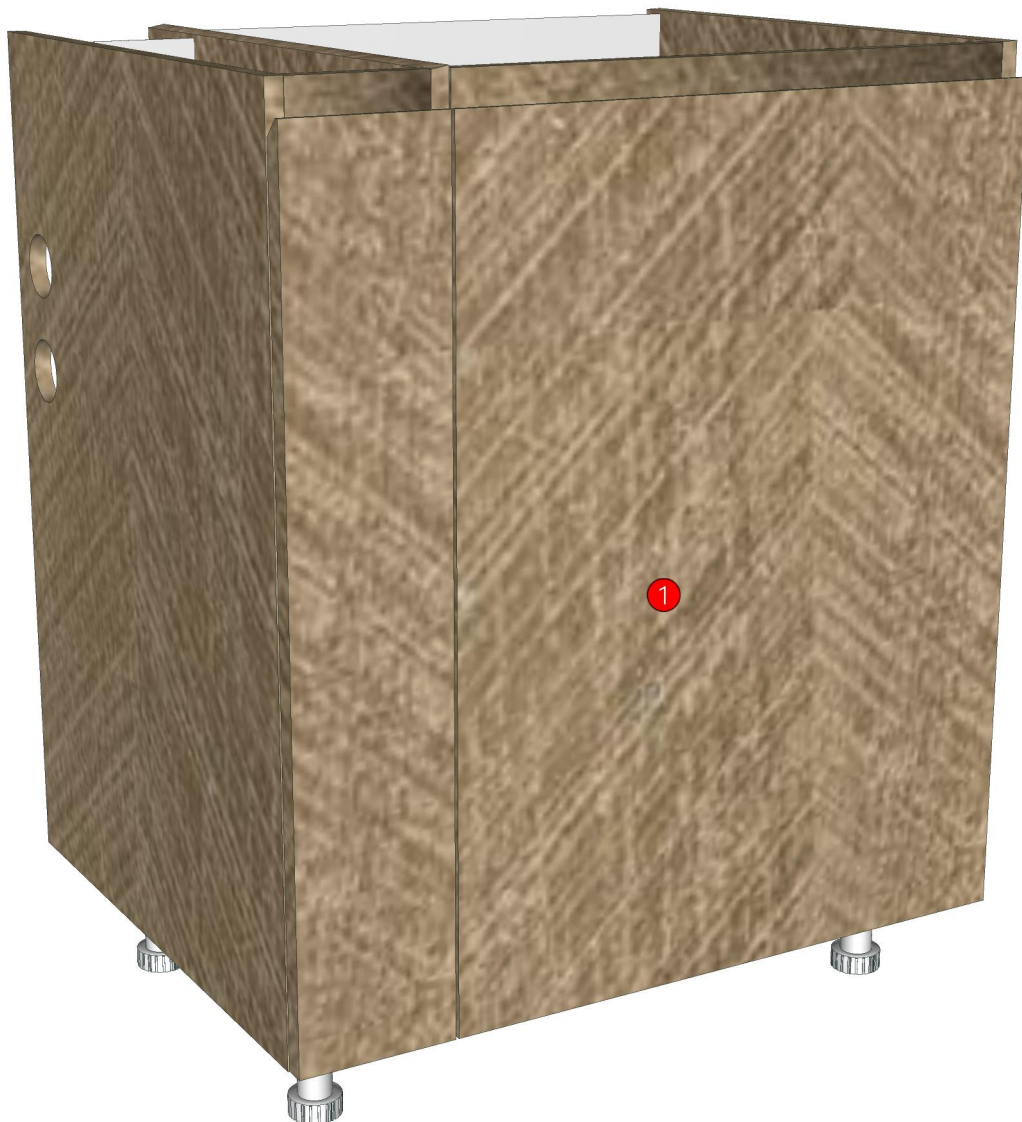

Model	-LIFE_CN2_DBS731RGL		
Creator		.BCP Name	INDEX_C3D_KITCHEN2
Reviewer		Order	I004492
Approves		Date	

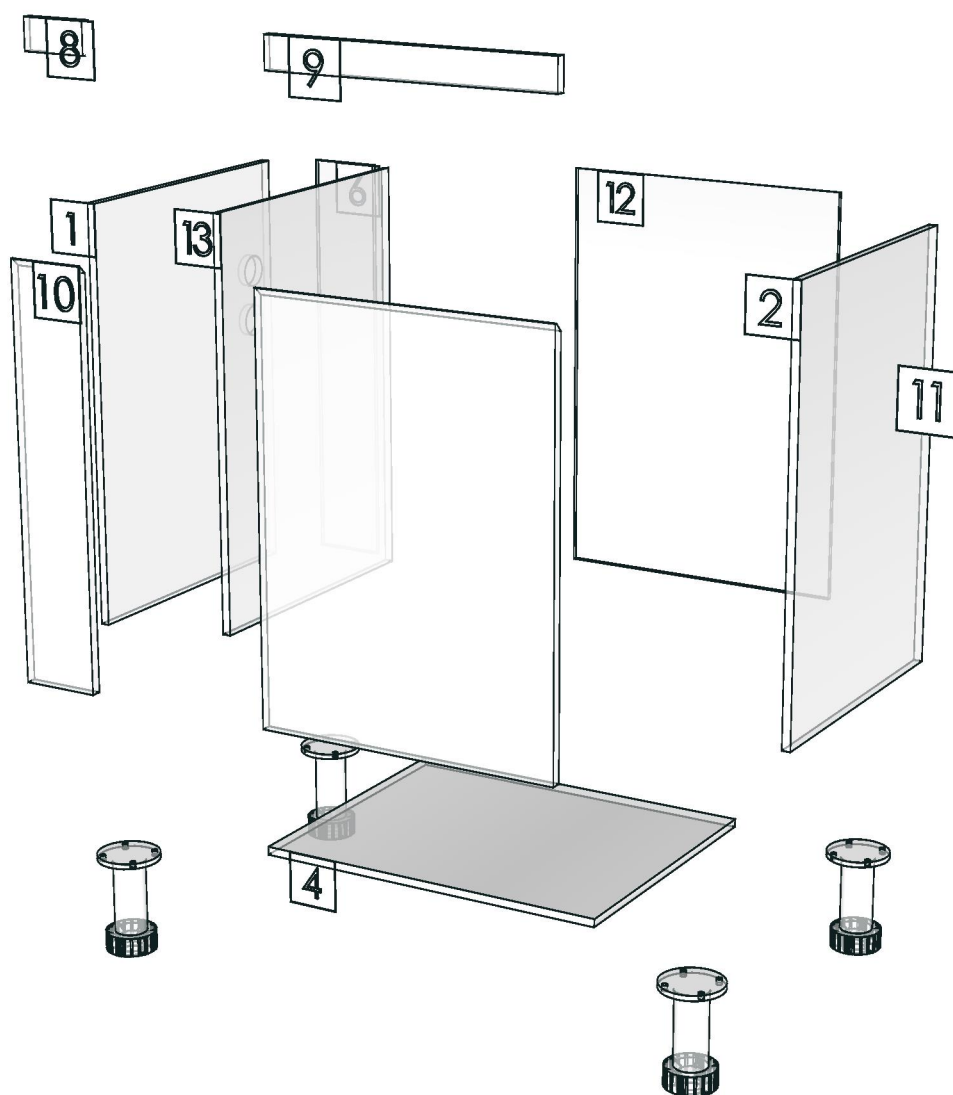

Model	LIFE_CN2_DDM600		
Creator	PASATHORN	.BCP Name	INDEX_C3D_KITCHEN2
Reviewer		Order	I004493
Approves	P.SAWAI	Date	13/10/2025

LIFE_CN2_DDM600-600X16X150

Colour

05.38 ML MD692 (SS)_

-

-

-

K100L-160169850

K100R-160169858

K102L-160169888

K102R-160169897

K105L-160169936

Edge

01.286 1 MD692 _

-

-

-

-

K113L-160169945

K113R-160169954

K115L-160169987

K115R-160169997

K118L-160170040

R&D REVIEW	
<input checked="" type="checkbox"/>	DWG.Customer
<input checked="" type="checkbox"/>	Work Report
<input type="checkbox"/>	Function
<input type="checkbox"/>	สินค้าตรงตัวอย่าง
ผู้ทบทวน <u>P.SAWAI</u>	
<u>25/10/25</u>	

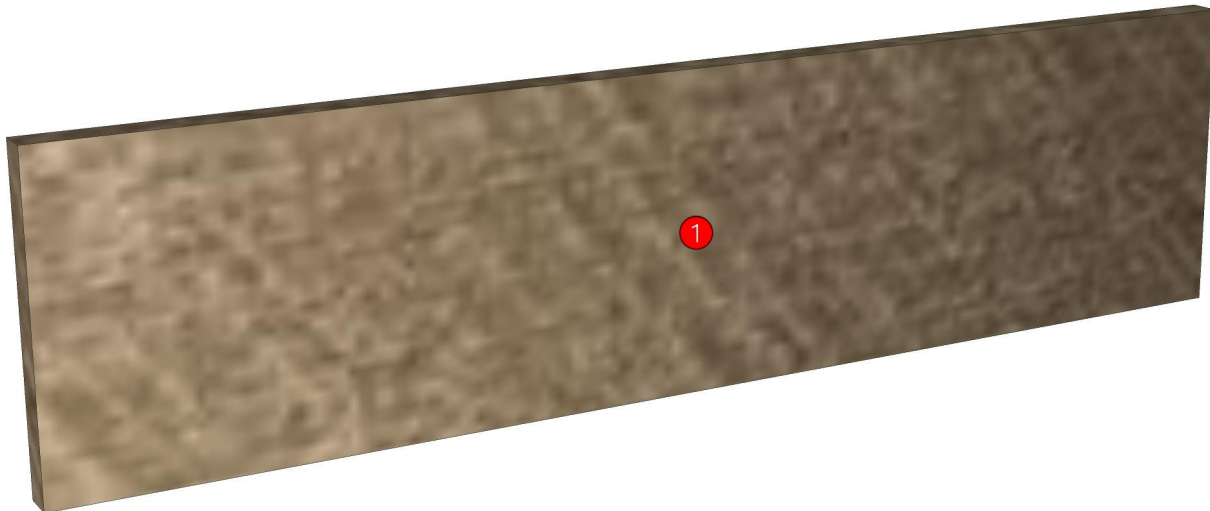

Model	LIFE_CN2_DDM600		
Creator	PASATHORN	.BCP Name	INDEX_C3D_KITCHEN2
Reviewer		Order	I004493
Approves	P. SAWAI	Date	13/10/2025

No.	Article No.	Description	Mat	Dimension	Cutting Size	Typepology	Skin
0	LIFE_CN2_DDM600 LIFE_CN2_DDM600-01	LIFE_CN2_DDM600 DDM-SP	PB-SP	600x150x16 16x150x600	16X148X598;L2:W2	183000_STR=05.38_EDG=MD692-1	2

Model	LIFE_CN2_DF_CL1400		
Creator	PASATHORN	.BCP Name	INDEX_C3D_KITCHEN2
Reviewer		Order	I004497
Approves	P.SAWAI	Date	13/10/2025

LIFE_CN2_DF_CL1400-1400X16X155

Colour

05.38 ML MD692 (SS)_

-

-

-

K100L-160169850

K100R-160169858

Edge

01.286 1 MD692 _

-

-

-

-

R&D REVIEW	
<input checked="" type="checkbox"/>	DWG.Customer
<input checked="" type="checkbox"/>	Work Report
<input type="checkbox"/>	Function
<input type="checkbox"/>	สินค้าตรงตัวอย่าง
ผู้ทบทวน <u>P.SAWAI</u>	
<u>13/10/2025</u>	

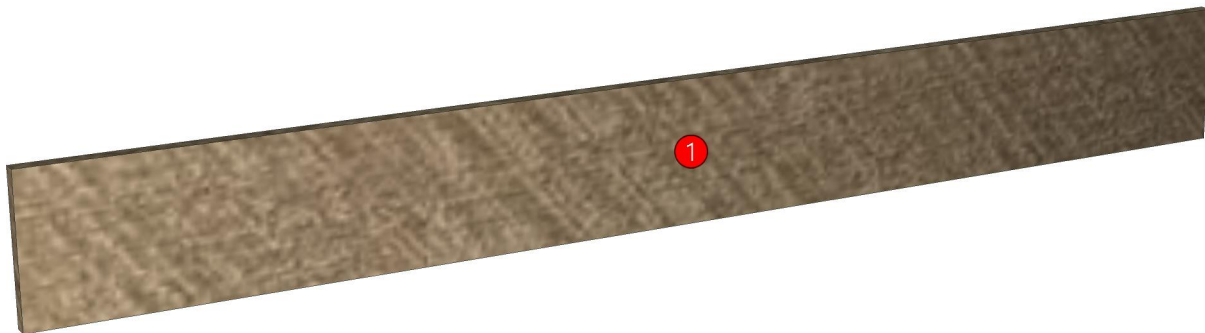

Model	LIFE_CN2_DF_CL1400		
Creator	PASATHORN	.BCP Name	INDEX_C3D_KITCHEN2
Reviewer		Order	I004497
Approves	P. SAWAI	Date	13/10/2025

No.	Article No.	Description	Mat	Dimension	Cutting Size	Typepology	Skin
0	LIFE_CN2_DF_CL1400	LIFE_CN2_DF_CL1400		1400x155x16			
	LIFE_CN2_DF_CL1400-01	DF_CL-SP	PB-SP	16x155x1400	16X154X1398;L1:W2	183000_STR=05.38_EDG=MD692-1	2

Model	LIFE_CN2_DF_CL350		
Creator	PASATHORN	.BCP Name	INDEX_C3D_KITCHEN2
Reviewer		Order	I004496
Approves	P.SAWAI	Date	13/10/2025

LIFE_CN2_DF_CL350-350X16X155

Colour

05.38 ML MD692 (SS)_

-

-

-

K100L-160169850

K100R-160169858

K102L-160169888

K102R-160169897

K103L-160169906

K103R-160169916

K104L-160169926

K105L-160169936

Edge

01.286 1 MD692 _

-

-

-

-

R&D REVIEW	
<input checked="" type="checkbox"/>	DWG.Customer
<input checked="" type="checkbox"/>	Work Report
<input type="checkbox"/>	Function
<input type="checkbox"/>	สินค้าตรงตัวอย่าง
ผู้ทบทวน <u>P.SAWAI</u>	
<u>25/10/25</u>	

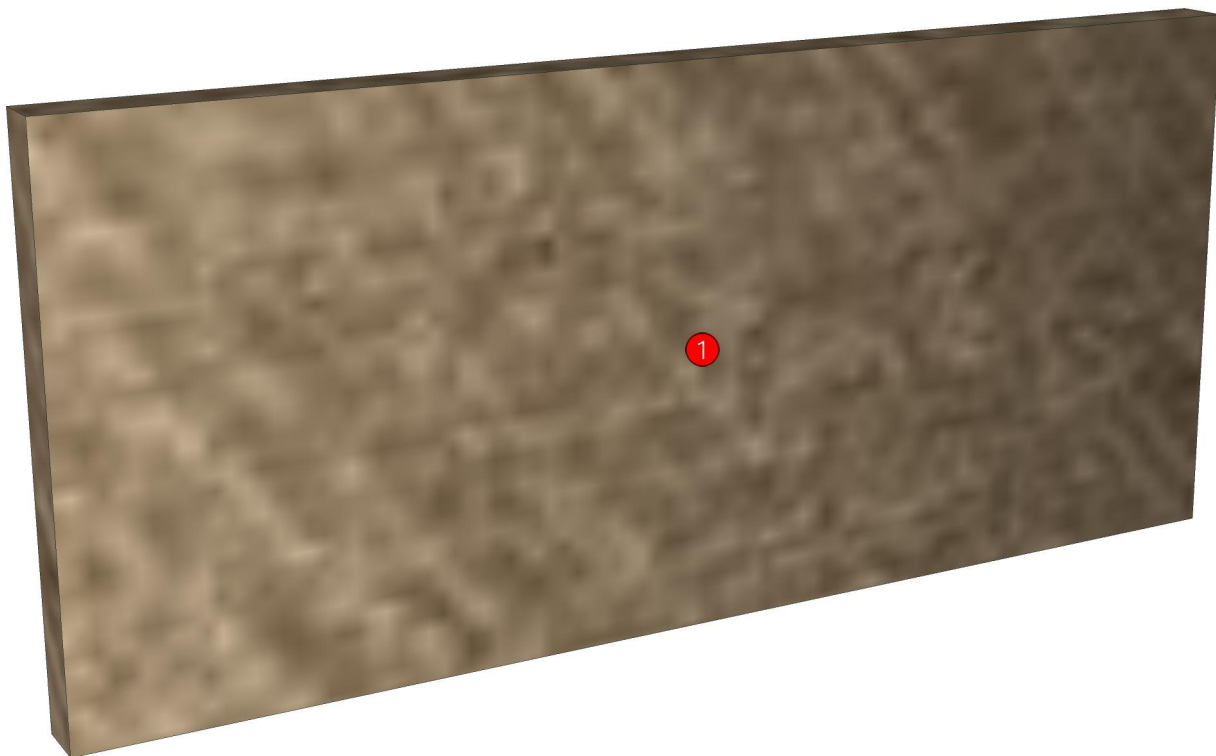

Model	LIFE_CN2_DF_CL350		
Creator	PASATHORN	.BCP Name	INDEX_C3D_KITCHEN2
Reviewer		Order	I004496
Approves	P. SAWAI	Date	13/10/2025

No.	Article No.	Description	Mat	Dimension	Cutting Size	Typepology	Skin
0	LIFE_CN2_DF_CL350	LIFE_CN2_DF_CL350		350x155x16			
	LIFE_CN2_DF_CL350-01	DF_CL-SP	PB-SP	16x155x350	16X154X349;L1:W1	183000 _STR=05.38 _EDG=MD692-1	2

Model	LIFE_CN2_DL60HLS		
Creator	PASATHORN	.BCP Name	INDEX_C3D_KITCHEN2
Reviewer		Order	I004510
Approves	<i>P.SAWAI</i>	Date	13/10/2025

LIFE_CN2_DL60HLS-600X350X860

Colour

05.38 ML MD692 (SS)_

05.30 ML WHITE SAND #VM1012/2610/2610(PEARL)_

-

-

-

K100R-160169858

Edge

01.286 1 MD692 _

01.47 1 WHITE _

-

-

-

K102R-160169897

R&D REVIEW	
<input checked="" type="checkbox"/>	DWG.Customer
<input checked="" type="checkbox"/>	Work Report
<input type="checkbox"/>	Function
<input type="checkbox"/>	สินค้าตรงตัวอย่าง
ผู้ทบทวน <u>P.SAWAI</u>	
<u>25/10/25</u>	

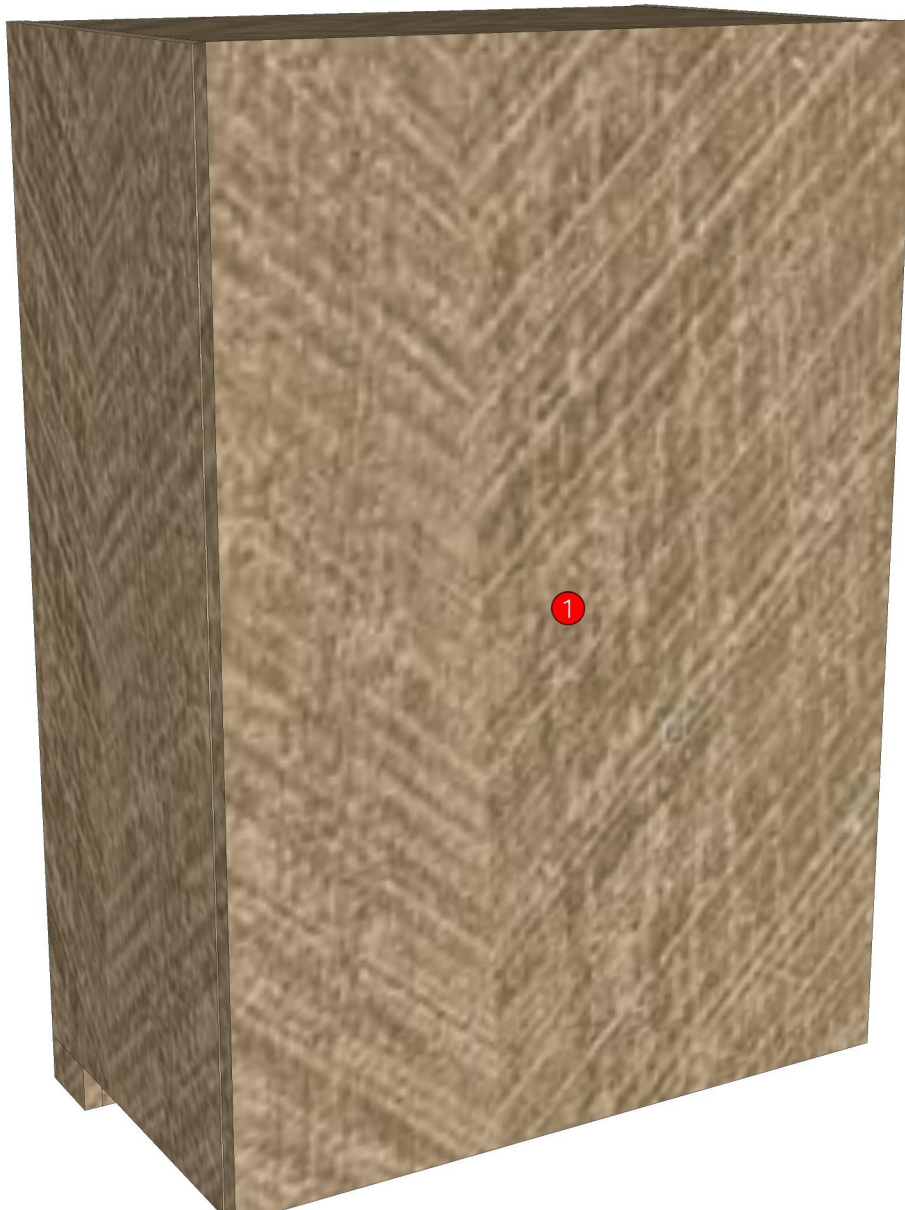

Model	-LIFE_CN2_DL60HLS		
Creator		.BCP Name	INDEX_C3D_KITCHEN2
Reviewer		Order	I004510
Approves	P.SAWAI	Date	

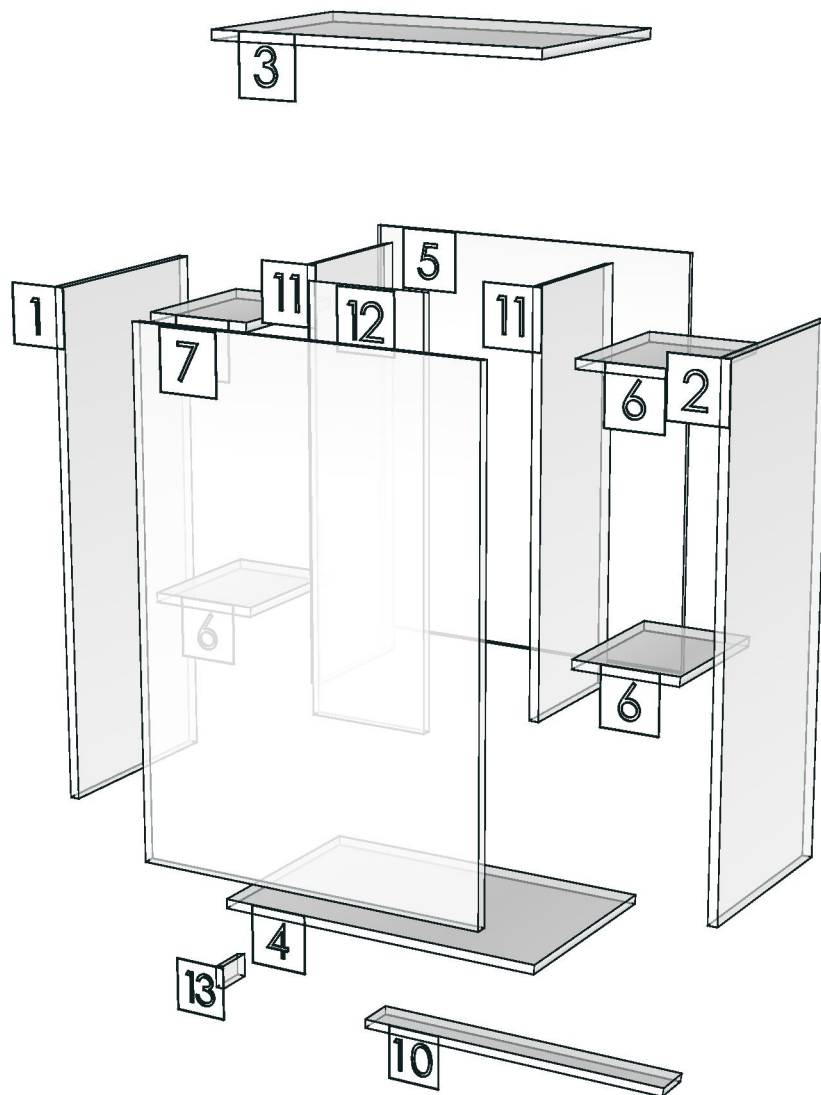

Model	LIFE_CN2_DLMV80R		
Creator	PASATHORN	.BCP Name	INDEX_C3D_KITCHEN2
Reviewer		Order	I004517
Approves	P.SAWAI	Date	13/10/2025

LIFE_CN2_DLMV80R-800X400X1050

Colour

05.38 ML MD692 (SS)_

05.30 ML WHITE SAND #VM1012/2610/2610(PEARL)_

-

-

-

K100R-160169858

Edge

01.286 1 MD692 _

01.47 1 WHITE _

-

-

-

R&D REVIEW	
<input checked="" type="checkbox"/>	DWG.Customer
<input checked="" type="checkbox"/>	Work Report
<input type="checkbox"/>	Function
<input type="checkbox"/>	สินค้าตรงตัวอย่าง
ผู้ทบทวน <u>P.SAWAI</u>	
<u>25/10/25</u>	

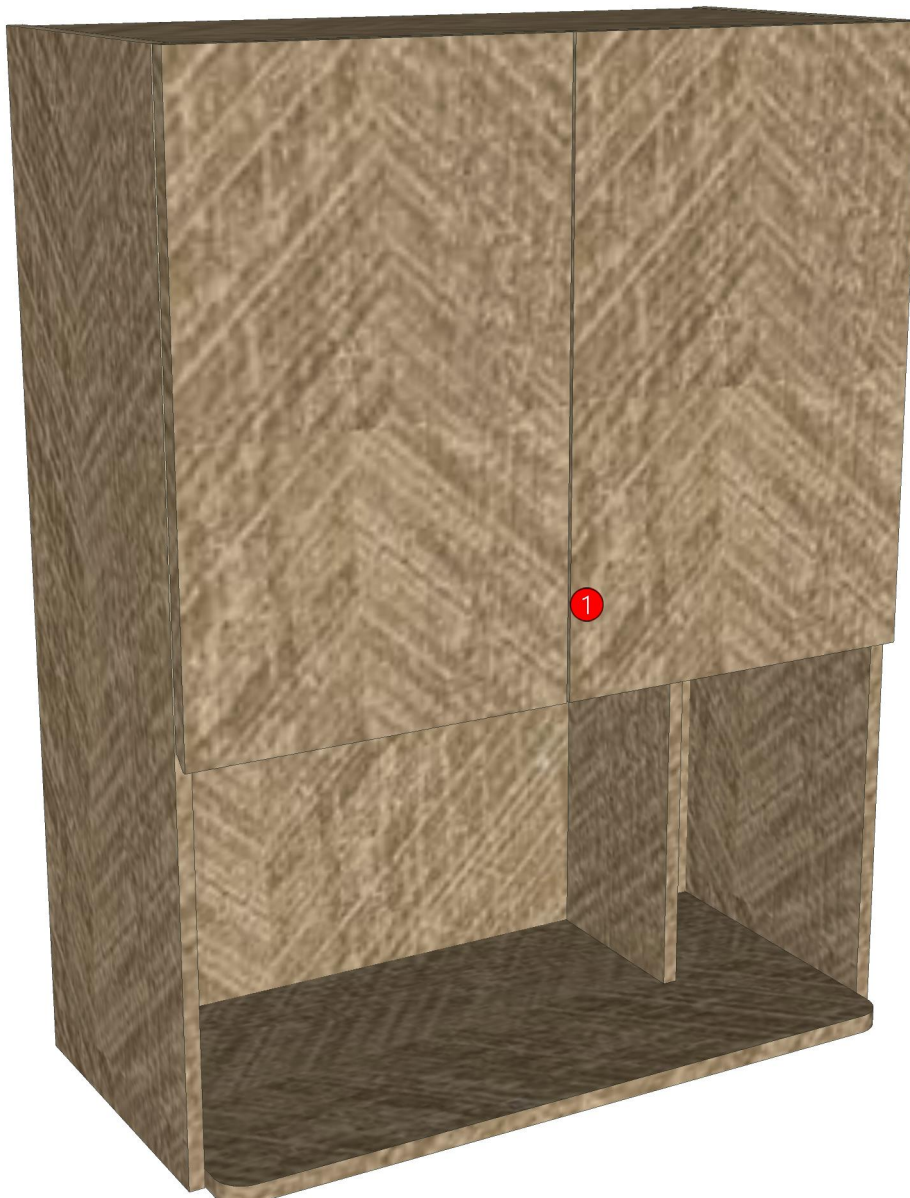

Model	-LIFE_CN2_DLMV80R		
Creator		.BCP Name	INDEX_C3D_KITCHEN2
Reviewer		Order	I004517
Approves	P. SAWAI	Date	

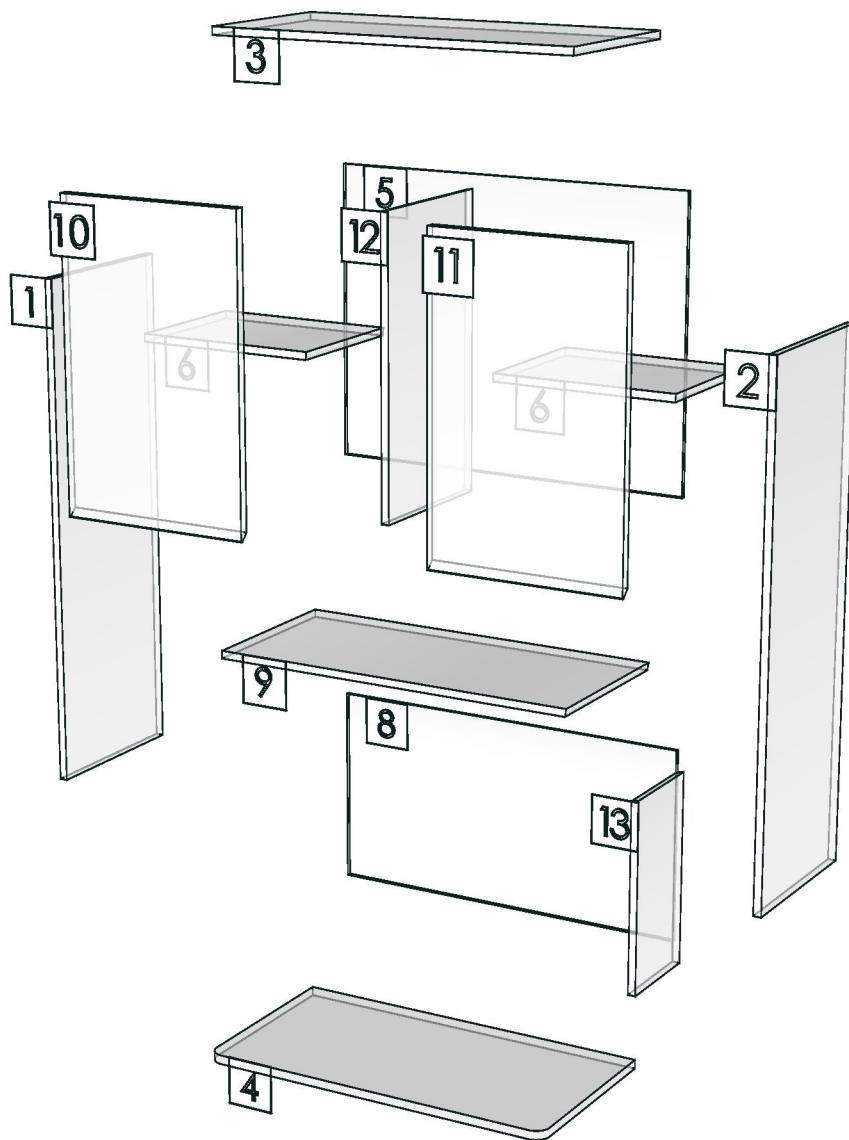

Model	LIFE_CN2_D_PLT600		
Creator	PASATHORN	.BCP Name	INDEX_C3D_KITCHEN2
Reviewer		Order	I004524
Approves	P.SAWAI	Date	16/10/2025

LIFE_CN2_D_PLT600-600X9X100

Colour

05.38 ML MD692 (SS)_

-

-

-

K100L-160169850

K100R-160169858

K101L-160169866

K101R-160169877

K102L-160169888

K102R-160169897

K103L-160169906

K103R-160169916

K104L-160169926

K105L-160169936

Edge

01.286 1 MD692 _

-

-

-

-

K113L-160169945

K113R-160169954

K114L-160169963

K114R-160169975

K115L-160169987

K115R-160169997

K116L-160170007

K116R-160170018

K117L-160170029

K118L-160170040

R&D REVIEW	
<input checked="" type="checkbox"/>	DWG.Customer
<input checked="" type="checkbox"/>	Work Report
<input type="checkbox"/>	Function
<input type="checkbox"/>	สินค้าตรงตัวอย่าง
ผู้ทบทวน <u>P.SAWAI</u>	
<u>25/10/25</u>	

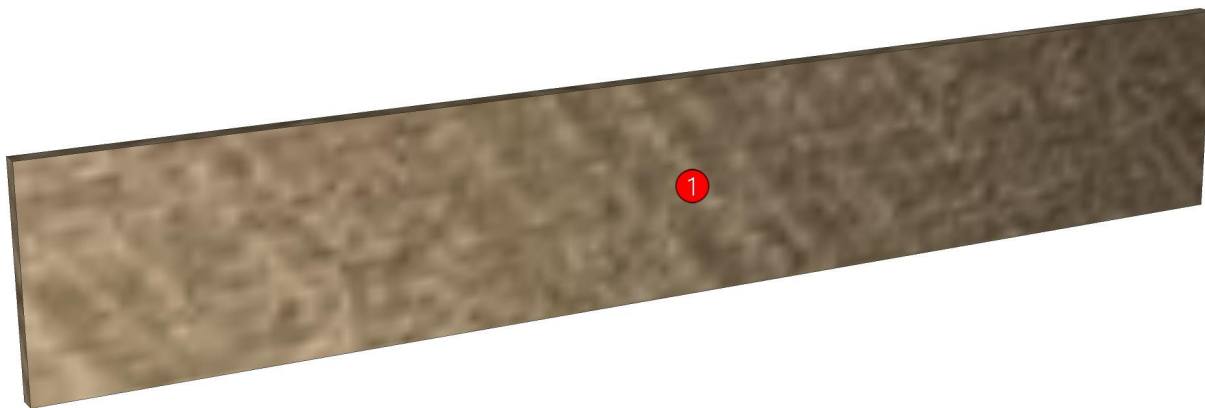

Model	LIFE_CN2_D_PLT600		
Creator	PASATHORN	.BCP Name	INDEX_C3D_KITCHEN2
Reviewer		Order	I004524
Approves	P. SAWAI	Date	16/10/2025

No.	Article No.	Description	Mat	Dimension	Cutting Size	Typepology	Skin
0	LIFE_CN2_D_PLT600	LIFE_CN2_D_PLT600		600x100x9			
	LIFE_CN2_D_PLT600-01	D_PLINT-SP	PB-SP	9x100x600	9X98X598;L2:W2	183000 _STR=05.38 _EDG=MD692-1	2

Model	LIFE_CN2_D_PLT731		
Creator	PASATHORN	.BCP Name	INDEX_C3D_KITCHEN2
Reviewer		Order	I004470
Approves	P.SAWAI	Date	13/10/2025

LIFE_CN2_D_PLT731-731X9X100

Colour

05.38 ML MD692 (SS)_

-

-

-

K100L-160169850

K100R-160169858

Edge

01.286 1 MD692 _

-

-

-

-

K113L-160169945

K113R-160169954

R&D REVIEW	
<input checked="" type="checkbox"/>	DWG.Customer
<input checked="" type="checkbox"/>	Work Report
<input type="checkbox"/>	Function
<input type="checkbox"/>	สินค้าตรงตัวอย่าง
ผู้ทบทวน <u>P.SAWAI</u>	
<u>13/10/2025</u>	

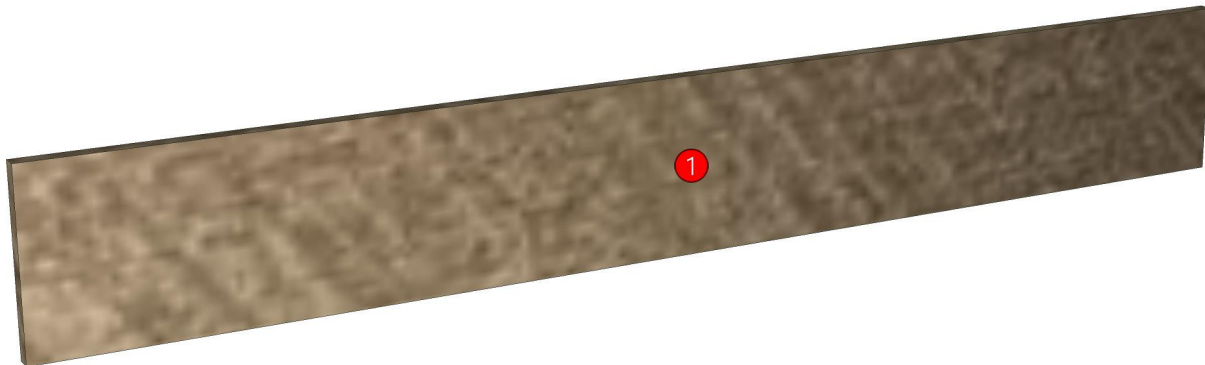

Model	LIFE_CN2_D_PLT731		
Creator	PASATHORN	.BCP Name	INDEX_C3D_KITCHEN2
Reviewer		Order	I004470
Approves	P. SAWAI	Date	13/10/2025

No.	Article No.	Description	Mat	Dimension	Cutting Size	Typepology	Skin
0	LIFE_CN2_D_PLT731	LIFE_CN2_D_PLT731		731x100x9			
	LIFE_CN2_D_PLT731-01	D_PLINT-SP	PB-SP	9x100x731	9X98X729;L2:W2	183000 _STR=05.38 _EDG=MD692-1	2