

|                 |                  |                  |                    |
|-----------------|------------------|------------------|--------------------|
| <b>Model</b>    | LIFE_CN2_DBO665R |                  |                    |
| <b>Creator</b>  | PASATHORN        | <b>.BCP Name</b> | INDEX_C3D_KITCHEN2 |
| <b>Reviewer</b> |                  | <b>Order</b>     | I004477            |
| <b>Approves</b> | P.SAWAI          | <b>Date</b>      | 13/10/2025         |

## **LIFE\_CN2\_DBO665R-665X570X913**

### **Colour**

05.38 ML MD692 (SS)\_

05.30 ML WHITE SAND #VM1012/2610/2610(PEARL)\_

-

-

K100L-160169850

K113L-160169945

### **Edge**

01.286 1 MD692 \_

01.47 1 WHITE \_

-

-

-

|                                     |                   |
|-------------------------------------|-------------------|
| <b>R&amp;D REVIEW</b>               |                   |
| <input checked="" type="checkbox"/> | DWG.Customer      |
| <input checked="" type="checkbox"/> | Work Report       |
| <input type="checkbox"/>            | Function          |
| <input type="checkbox"/>            | สินค้าตรงตัวอย่าง |
| ผู้ทบทวน <u>P.SAWAI</u>             |                   |
| <u>13/10/2025</u>                   |                   |

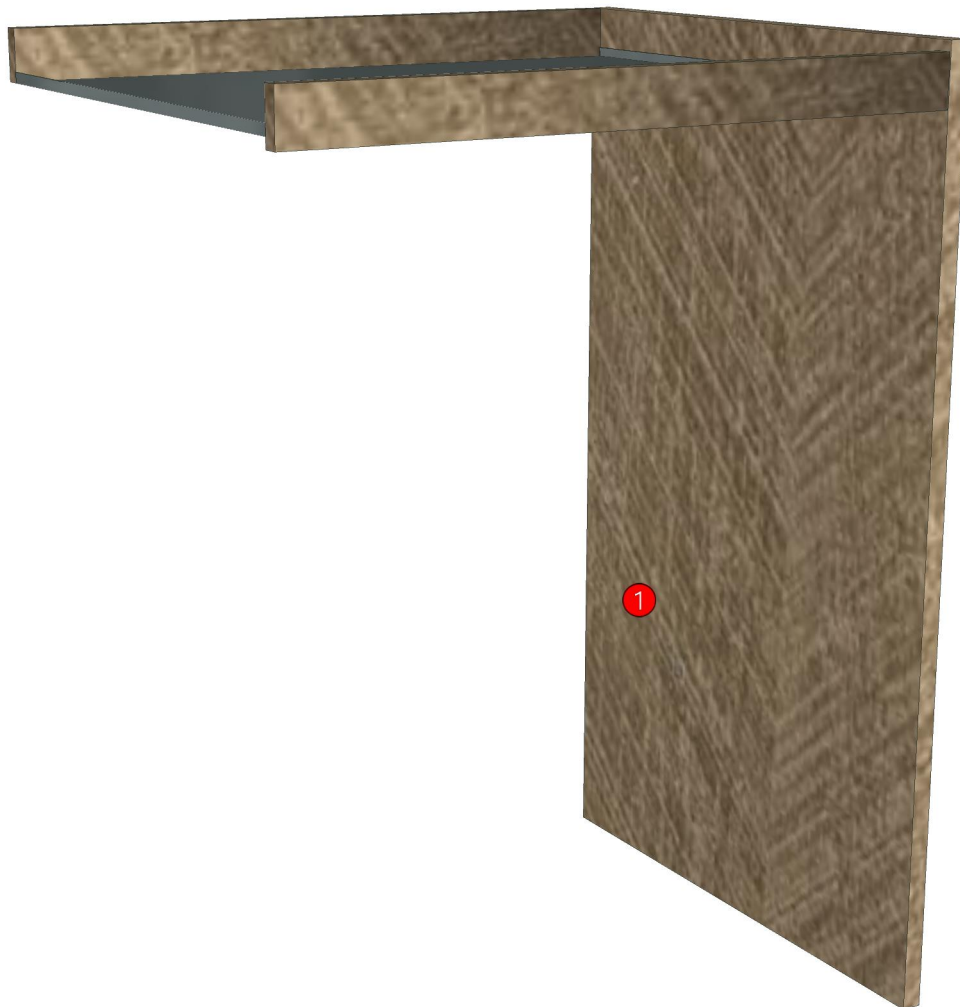

|                 |                   |                  |                    |
|-----------------|-------------------|------------------|--------------------|
| <b>Model</b>    | -LIFE_CN2_DBO665R |                  |                    |
| <b>Creator</b>  |                   | <b>.BCP Name</b> | INDEX_C3D_KITCHEN2 |
| <b>Reviewer</b> |                   | <b>Order</b>     | I004477            |
| <b>Approves</b> | P.SAWAI           | <b>Date</b>      |                    |

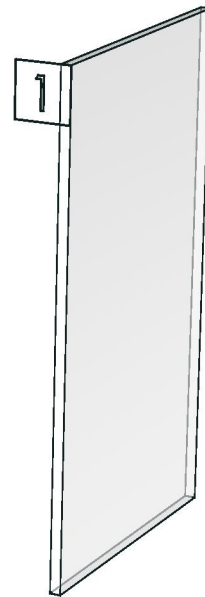
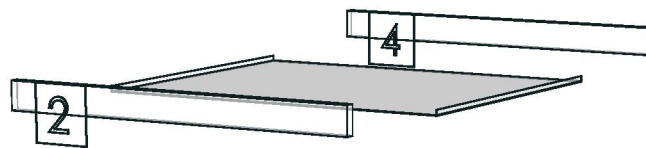

|                 |                    |                  |                    |
|-----------------|--------------------|------------------|--------------------|
| <b>Model</b>    | LIFE_CN2_DBS731LGR |                  |                    |
| <b>Creator</b>  | PASATHORN          | <b>.BCP Name</b> | INDEX_C3D_KITCHEN2 |
| <b>Reviewer</b> |                    | <b>Order</b>     | I004523            |
| <b>Approves</b> |                    | <b>Date</b>      | 16/10/2025         |

## **LIFE\_CN2\_DBS731LGR-731X570X913**

### **Colour**

05.38 ML MD692 (SS)\_

05.30 ML WHITE SAND #VM1012/2610/2610(PEARL)\_

-

-

K100L-160169850

### **Edge**

01.286 1 MD692 \_

01.465 0.6 CHARLOTTE MD692 (A1519TH00)\_

-

-

-

K113L-160169945\_E



|                                     |                   |
|-------------------------------------|-------------------|
| <b>R&amp;D REVIEW</b>               |                   |
| <input checked="" type="checkbox"/> | DWG.Customer      |
| <input checked="" type="checkbox"/> | Work Report       |
| <input type="checkbox"/>            | Function          |
| <input type="checkbox"/>            | สินค้าตรงตัวอย่าง |
| ผู้ทบทวน _____                      |                   |
| _____                               |                   |

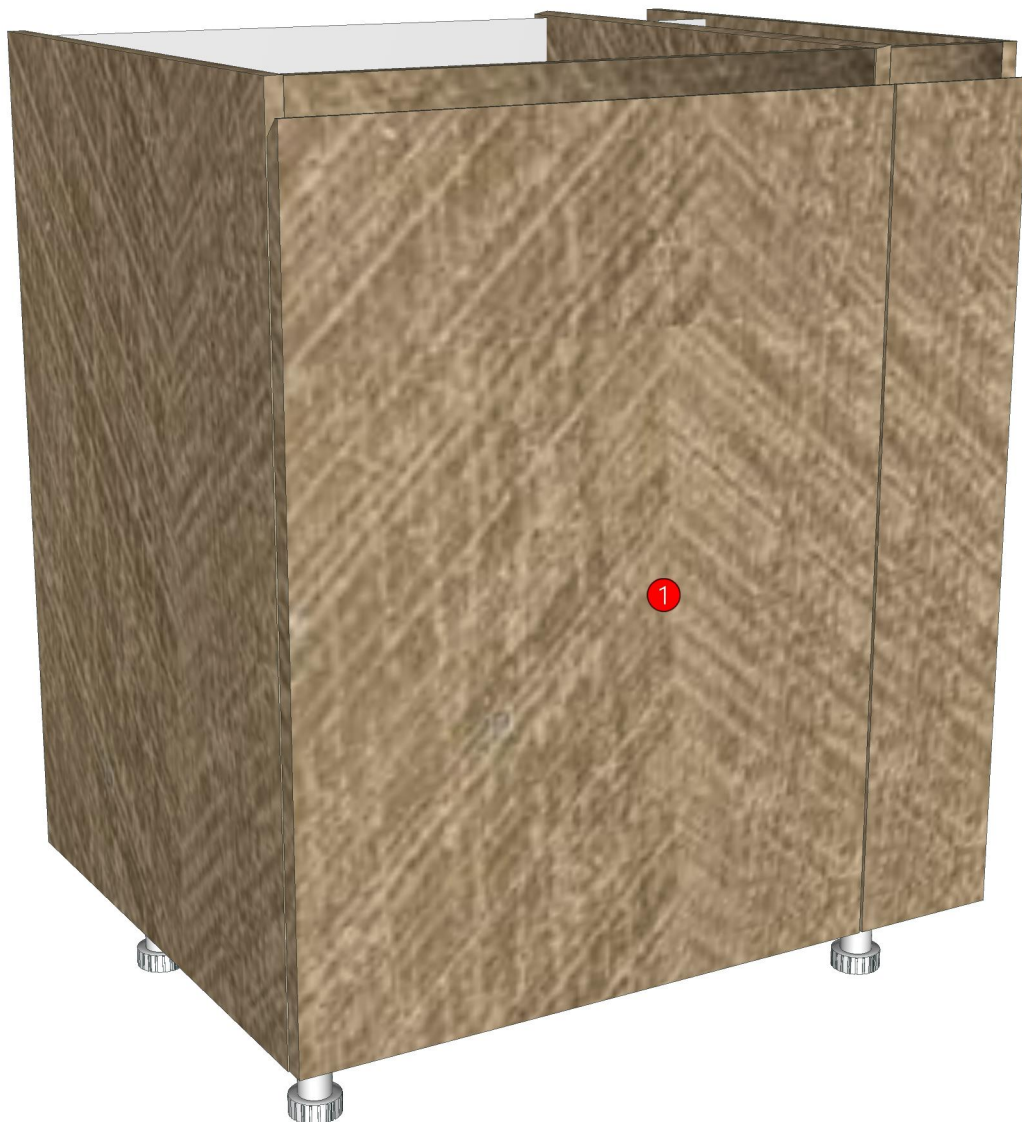

|                 |                     |                  |                    |
|-----------------|---------------------|------------------|--------------------|
| <b>Model</b>    | -LIFE_CN2_DBS731LGR |                  |                    |
| <b>Creator</b>  |                     | <b>.BCP Name</b> | INDEX_C3D_KITCHEN2 |
| <b>Reviewer</b> |                     | <b>Order</b>     | I004523            |
| <b>Approves</b> |                     | <b>Date</b>      |                    |

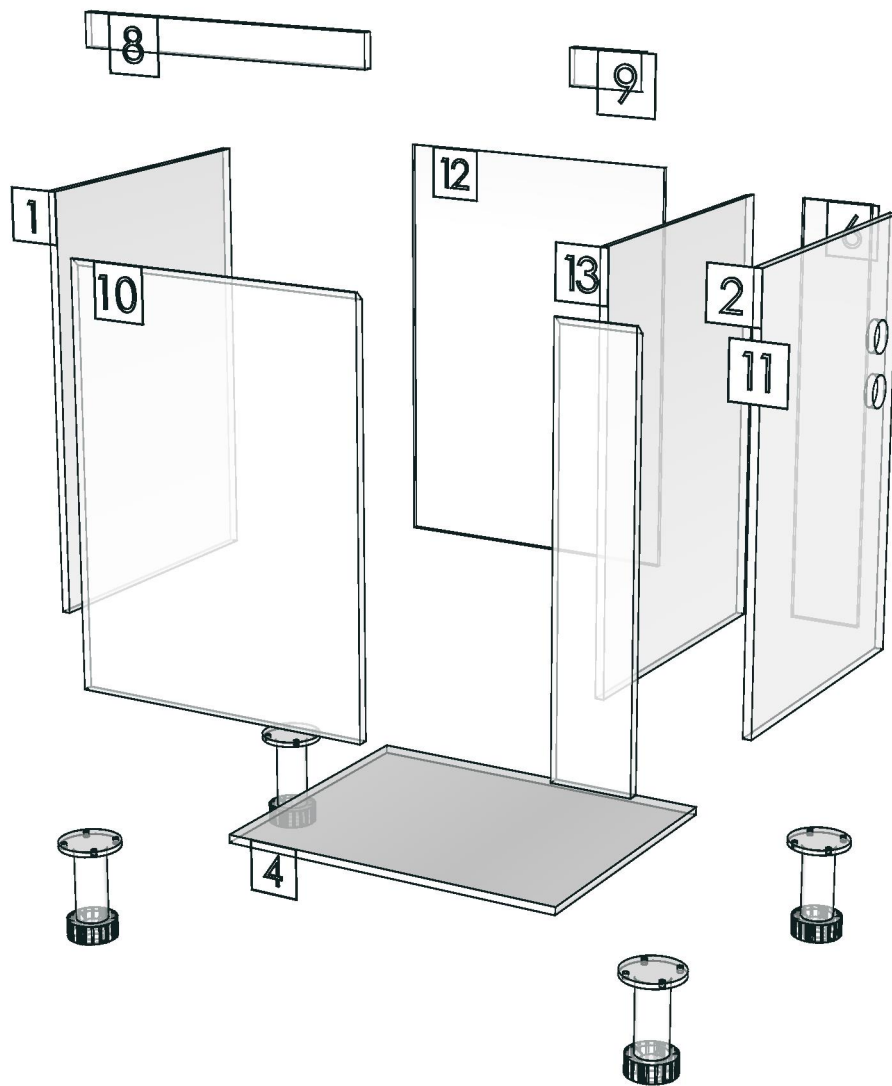

|                 |                 |                  |                    |
|-----------------|-----------------|------------------|--------------------|
| <b>Model</b>    | LIFE_CN2_DDM600 |                  |                    |
| <b>Creator</b>  | PASATHORN       | <b>.BCP Name</b> | INDEX_C3D_KITCHEN2 |
| <b>Reviewer</b> |                 | <b>Order</b>     | I004493            |
| <b>Approves</b> | P.SAWAI         | <b>Date</b>      | 13/10/2025         |

## **LIFE\_CN2\_DDM600-600X16X150**

### **Colour**

05.38 ML MD692 (SS)\_

-

-

-

K100L-160169850

K100R-160169858

K102L-160169888

K102R-160169897

K105L-160169936

### **Edge**

01.286 1 MD692 \_

-

-

-

-

K113L-160169945

K113R-160169954

K115L-160169987

K115R-160169997

K118L-160170040

|                                     |                   |
|-------------------------------------|-------------------|
| <b>R&amp;D REVIEW</b>               |                   |
| <input checked="" type="checkbox"/> | DWG.Customer      |
| <input checked="" type="checkbox"/> | Work Report       |
| <input type="checkbox"/>            | Function          |
| <input type="checkbox"/>            | สินค้าตรงตัวอย่าง |
| ผู้ทบทวน <u>P.SAWAI</u>             |                   |
| <u>25/10/25</u>                     |                   |

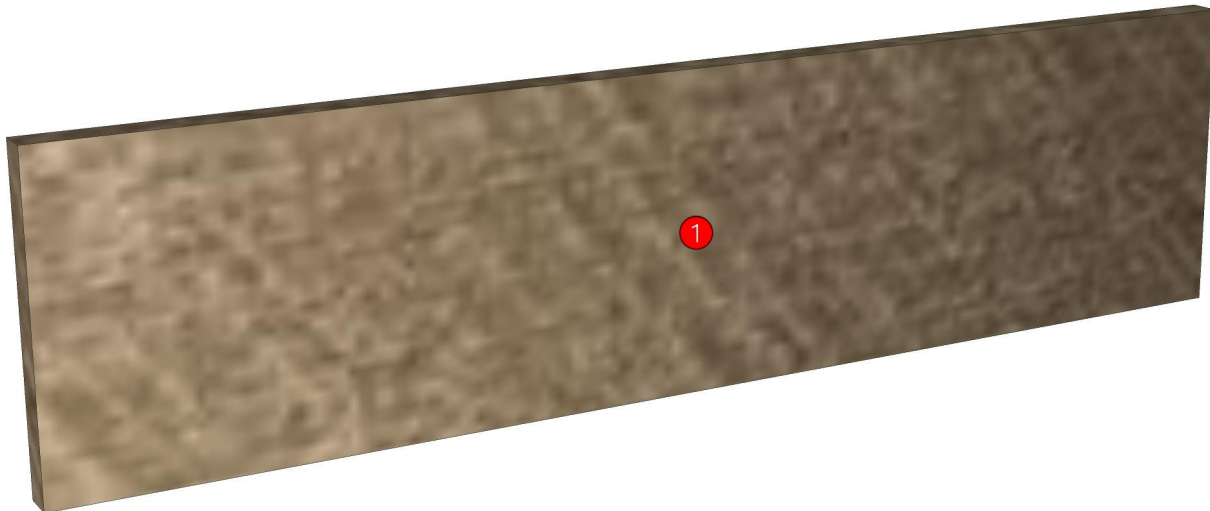

|                 |                 |                  |                    |
|-----------------|-----------------|------------------|--------------------|
| <b>Model</b>    | LIFE_CN2_DDM600 |                  |                    |
| <b>Creator</b>  | PASATHORN       | <b>.BCP Name</b> | INDEX_C3D_KITCHEN2 |
| <b>Reviewer</b> |                 | <b>Order</b>     | I004493            |
| <b>Approves</b> | P. SAWAI        | <b>Date</b>      | 13/10/2025         |

| No. | Article No.        | Description     | Mat   | Dimension  | Cutting Size     | Typepology                     | Skin |
|-----|--------------------|-----------------|-------|------------|------------------|--------------------------------|------|
| 0   | LIFE_CN2_DDM600    | LIFE_CN2_DDM600 |       | 600x150x16 |                  |                                |      |
|     | LIFE_CN2_DDM600-01 | DDM-SP          | PB-SP | 16x150x600 | 16X148X598;L2:W2 | 183000 _STR=05.38 _EDG=MD692-1 | 2    |

|                 |                    |                  |                    |
|-----------------|--------------------|------------------|--------------------|
| <b>Model</b>    | LIFE_CN2_DF_CL1400 |                  |                    |
| <b>Creator</b>  | PASATHORN          | <b>.BCP Name</b> | INDEX_C3D_KITCHEN2 |
| <b>Reviewer</b> |                    | <b>Order</b>     | I004497            |
| <b>Approves</b> | P.SAWAI            | <b>Date</b>      | 13/10/2025         |

## LIFE\_CN2\_DF\_CL1400-1400X16X155

**Colour**

05.38 ML MD692 (SS)\_

-

-

-

K100L-160169850

K100R-160169858

**Edge**

01.286 1 MD692 \_

-

-

-

-

|                                     |                   |
|-------------------------------------|-------------------|
| <b>R&amp;D REVIEW</b>               |                   |
| <input checked="" type="checkbox"/> | DWG.Customer      |
| <input checked="" type="checkbox"/> | Work Report       |
| <input type="checkbox"/>            | Function          |
| <input type="checkbox"/>            | สินค้าตรงตัวอย่าง |
| ผู้ทบทวน <u>P.SAWAI</u>             |                   |
| <u>13/10/2025</u>                   |                   |

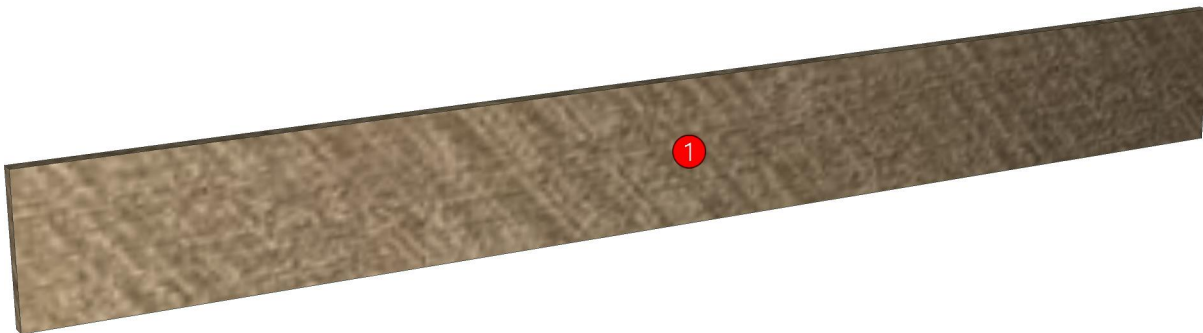

|                 |                    |                  |                    |
|-----------------|--------------------|------------------|--------------------|
| <b>Model</b>    | LIFE_CN2_DF_CL1400 |                  |                    |
| <b>Creator</b>  | PASATHORN          | <b>.BCP Name</b> | INDEX_C3D_KITCHEN2 |
| <b>Reviewer</b> |                    | <b>Order</b>     | I004497            |
| <b>Approves</b> | P. SAWAI           | <b>Date</b>      | 13/10/2025         |

| No. | Article No.           | Description        | Mat   | Dimension   | Cutting Size      | Typepology                     | Skin |
|-----|-----------------------|--------------------|-------|-------------|-------------------|--------------------------------|------|
| 0   | LIFE_CN2_DF_CL1400    | LIFE_CN2_DF_CL1400 |       | 1400x155x16 |                   |                                |      |
|     | LIFE_CN2_DF_CL1400-01 | DF_CL-SP           | PB-SP | 16x155x1400 | 16X154X1398;L1:W2 | 183000 _STR=05.38 _EDG=MD692-1 | 2    |

|                 |                   |                  |                    |
|-----------------|-------------------|------------------|--------------------|
| <b>Model</b>    | LIFE_CN2_DF_CL350 |                  |                    |
| <b>Creator</b>  | PASATHORN         | <b>.BCP Name</b> | INDEX_C3D_KITCHEN2 |
| <b>Reviewer</b> |                   | <b>Order</b>     | I004496            |
| <b>Approves</b> | P.SAWAI           | <b>Date</b>      | 13/10/2025         |

## LIFE\_CN2\_DF\_CL350-350X16X155

### Colour

05.38 ML MD692 (SS)\_

-

-

-

K100L-160169850

K100R-160169858

K102L-160169888

K102R-160169897

K103L-160169906

K103R-160169916

K104L-160169926

K105L-160169936

### Edge

01.286 1 MD692 \_

-

-

-

-

|                                     |                   |
|-------------------------------------|-------------------|
| <b>R&amp;D REVIEW</b>               |                   |
| <input checked="" type="checkbox"/> | DWG.Customer      |
| <input checked="" type="checkbox"/> | Work Report       |
| <input type="checkbox"/>            | Function          |
| <input type="checkbox"/>            | สินค้าตรงตัวอย่าง |
| ผู้ทบทวน <u>P.SAWAI</u>             |                   |
| <u>25/10/25</u>                     |                   |

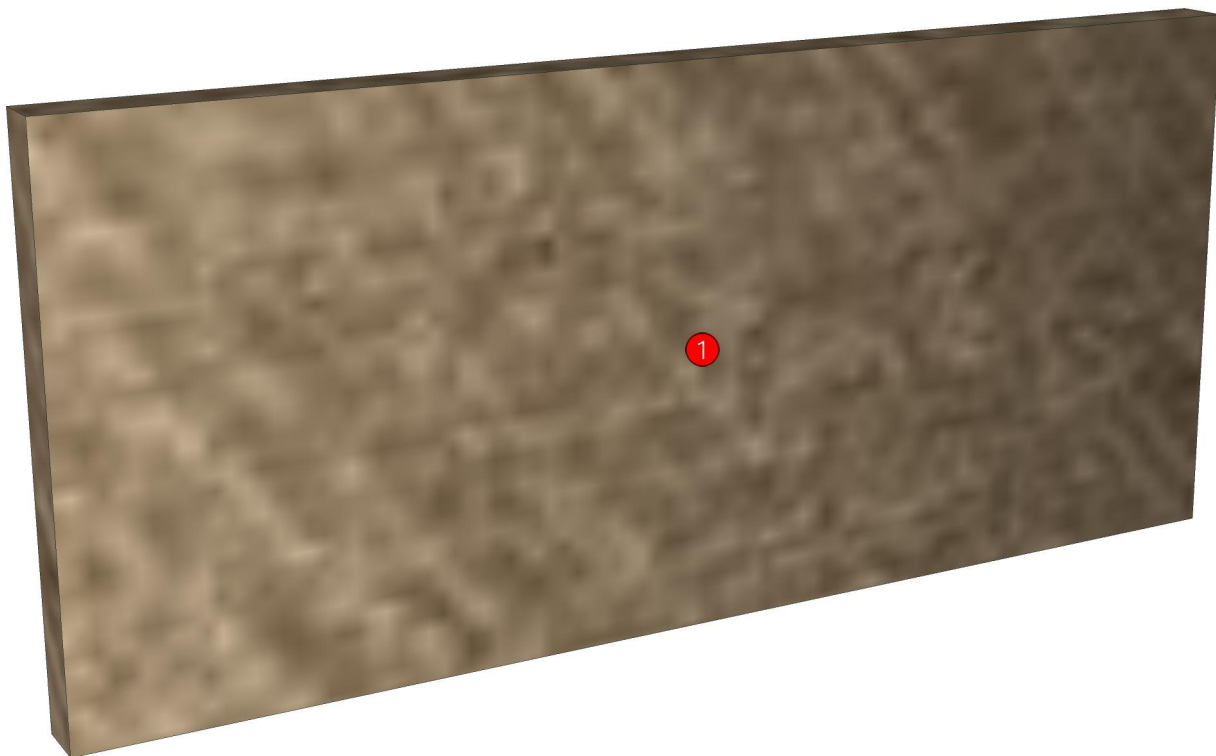

|                 |                   |                  |                    |
|-----------------|-------------------|------------------|--------------------|
| <b>Model</b>    | LIFE_CN2_DF_CL350 |                  |                    |
| <b>Creator</b>  | PASATHORN         | <b>.BCP Name</b> | INDEX_C3D_KITCHEN2 |
| <b>Reviewer</b> |                   | <b>Order</b>     | I004496            |
| <b>Approves</b> | P. SAWAI          | <b>Date</b>      | 13/10/2025         |

| No. | Article No.          | Description       | Mat   | Dimension  | Cutting Size     | Typepology                     | Skin |
|-----|----------------------|-------------------|-------|------------|------------------|--------------------------------|------|
| 0   | LIFE_CN2_DF_CL350    | LIFE_CN2_DF_CL350 |       | 350x155x16 |                  |                                |      |
|     | LIFE_CN2_DF_CL350-01 | DF_CL-SP          | PB-SP | 16x155x350 | 16X154X349;L1:W1 | 183000 _STR=05.38 _EDG=MD692-1 | 2    |

|                 |                  |                  |                    |
|-----------------|------------------|------------------|--------------------|
| <b>Model</b>    | LIFE_CN2_DL60HRS |                  |                    |
| <b>Creator</b>  | PASATHORN        | <b>.BCP Name</b> | INDEX_C3D_KITCHEN2 |
| <b>Reviewer</b> |                  | <b>Order</b>     | I004512            |
| <b>Approves</b> | P.SAWAI          | <b>Date</b>      | 13/10/2025         |

## **LIFE\_CN2\_DL60HRS-600X350X860**

### **Colour**

05.38 ML MD692 (SS)\_

05.30 ML WHITE SAND #VM1012/2610/2610(PEARL)\_

-

-

K100L-160169850

### **Edge**

01.286 1 MD692 \_

01.47 1 WHITE \_

-

-

-

|                                     |                   |
|-------------------------------------|-------------------|
| <b>R&amp;D REVIEW</b>               |                   |
| <input checked="" type="checkbox"/> | DWG.Customer      |
| <input checked="" type="checkbox"/> | Work Report       |
| <input type="checkbox"/>            | Function          |
| <input type="checkbox"/>            | สินค้าตรงตัวอย่าง |
| ผู้ทบทวน <u>P.SAWAI</u>             |                   |
| <u>25/10/25</u>                     |                   |

K102L-160169888

K105L-160169936

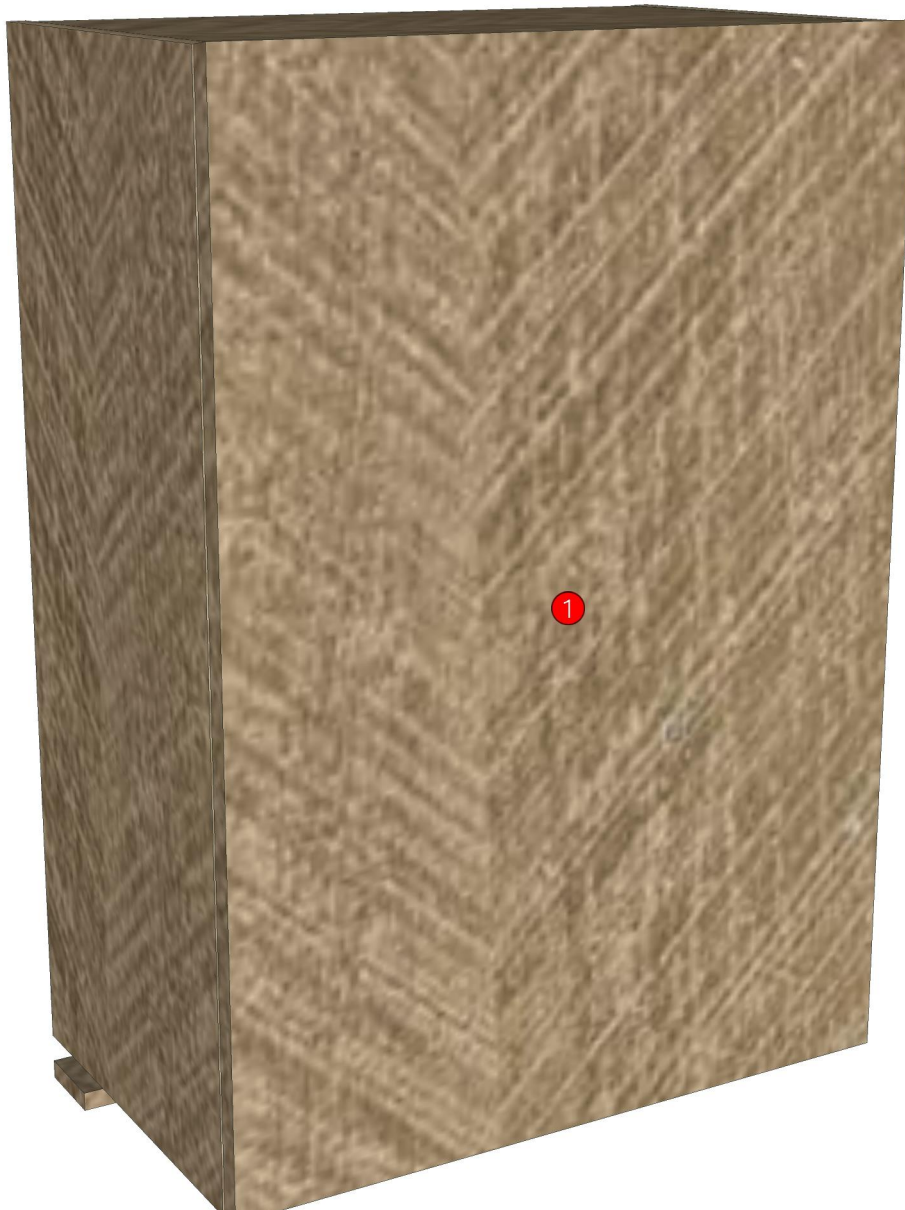

|                 |                   |                  |                    |
|-----------------|-------------------|------------------|--------------------|
| <b>Model</b>    | -LIFE_CN2_DL60HRS |                  |                    |
| <b>Creator</b>  |                   | <b>.BCP Name</b> | INDEX_C3D_KITCHEN2 |
| <b>Reviewer</b> |                   | <b>Order</b>     | I004512            |
| <b>Approves</b> | P.SAWAI           | <b>Date</b>      |                    |

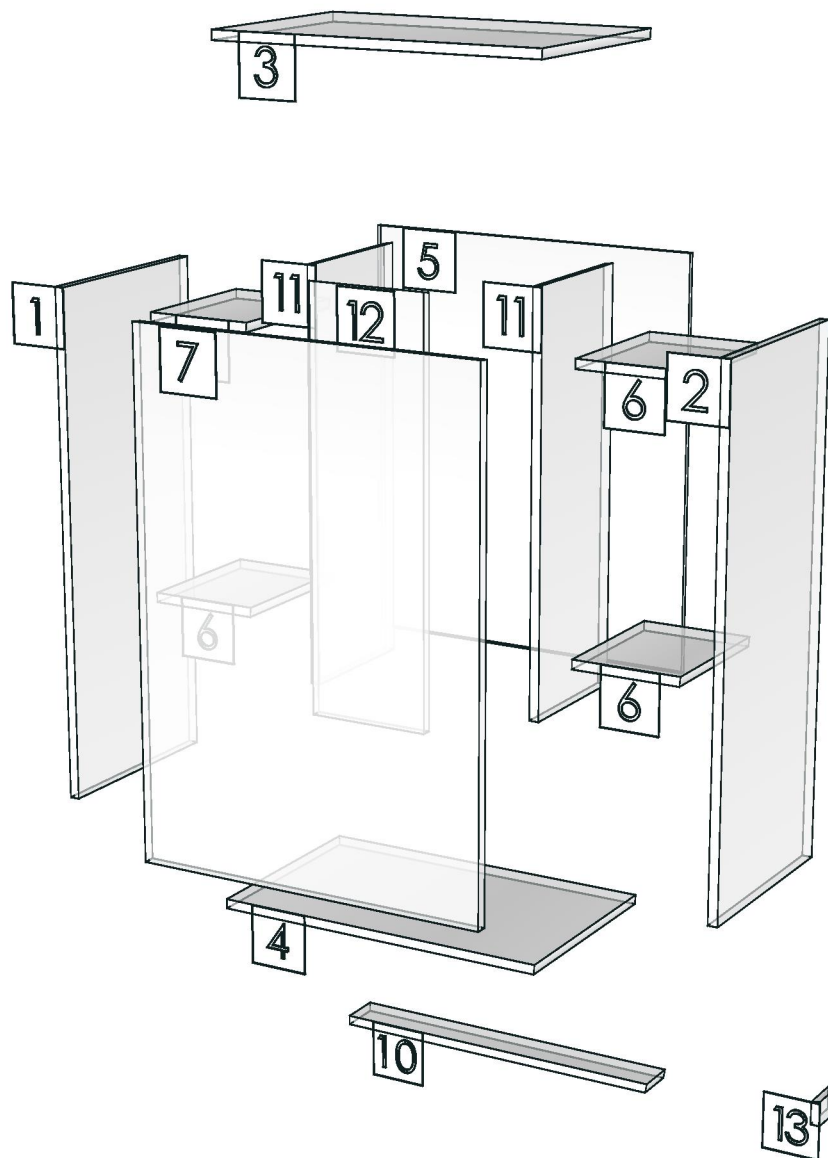

|                 |                  |                  |                    |
|-----------------|------------------|------------------|--------------------|
| <b>Model</b>    | LIFE_CN2_DLMV80L |                  |                    |
| <b>Creator</b>  | PASATHORN        | <b>.BCP Name</b> | INDEX_C3D_KITCHEN2 |
| <b>Reviewer</b> |                  | <b>Order</b>     | I004516            |
| <b>Approves</b> | P.SAWAI          | <b>Date</b>      | 13/10/2025         |

## **LIFE\_CN2\_DLMV80L-800X400X1050**

### **Colour**

05.38 ML MD692 (SS)\_

05.30 ML WHITE SAND #VM1012/2610/2610(PEARL)\_

-

-

K100L-160169850

### **Edge**

01.286 1 MD692 \_

01.47 1 WHITE \_

-

-

-

|                                     |                   |
|-------------------------------------|-------------------|
| <b>R&amp;D REVIEW</b>               |                   |
| <input checked="" type="checkbox"/> | DWG.Customer      |
| <input checked="" type="checkbox"/> | Work Report       |
| <input type="checkbox"/>            | Function          |
| <input type="checkbox"/>            | สินค้าตรงตัวอย่าง |
| ผู้ทบทวน <u>P.SAWAI</u>             |                   |
| <u>25/10/25</u>                     |                   |

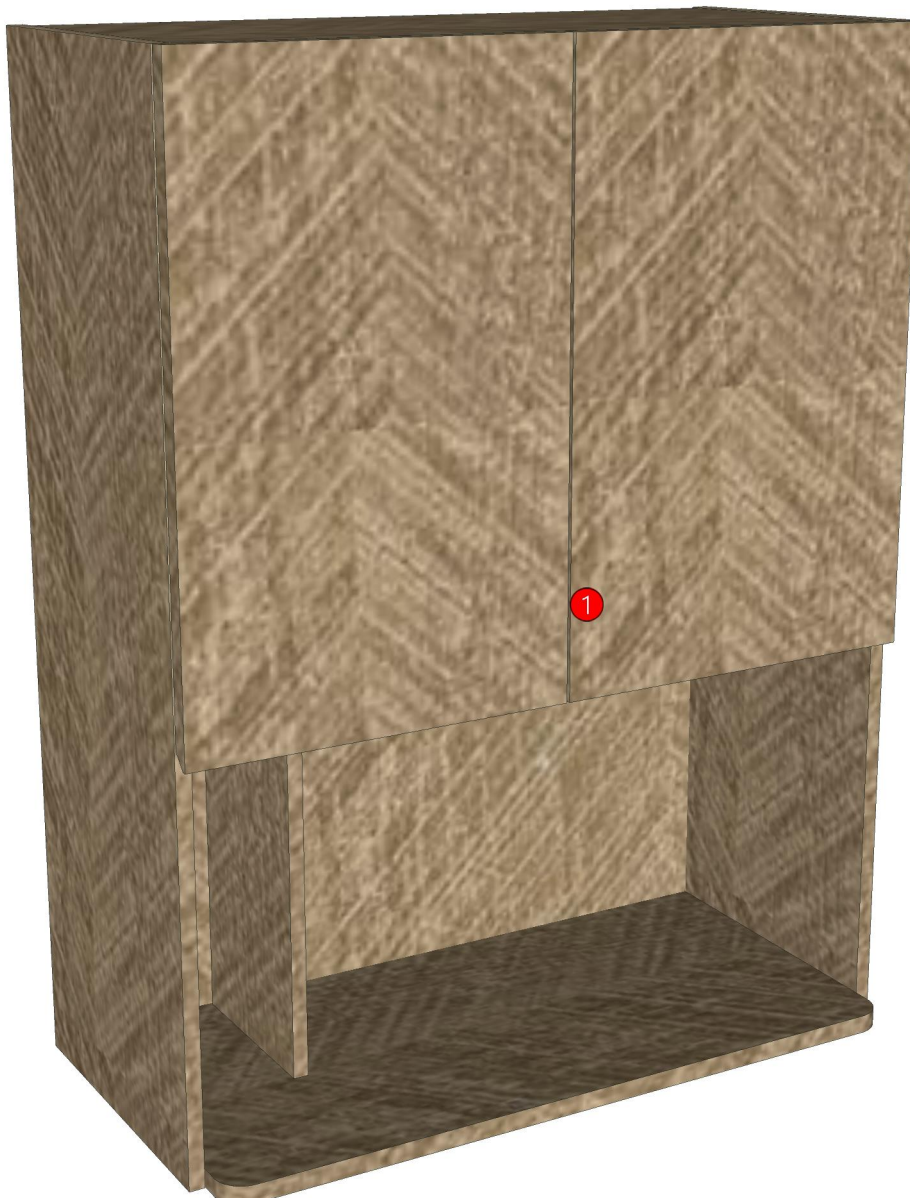

|                 |                   |                  |                    |
|-----------------|-------------------|------------------|--------------------|
| <b>Model</b>    | -LIFE_CN2_DLMV80L |                  |                    |
| <b>Creator</b>  |                   | <b>.BCP Name</b> | INDEX_C3D_KITCHEN2 |
| <b>Reviewer</b> |                   | <b>Order</b>     | I004516            |
| <b>Approves</b> | P. SAWAI          | <b>Date</b>      |                    |

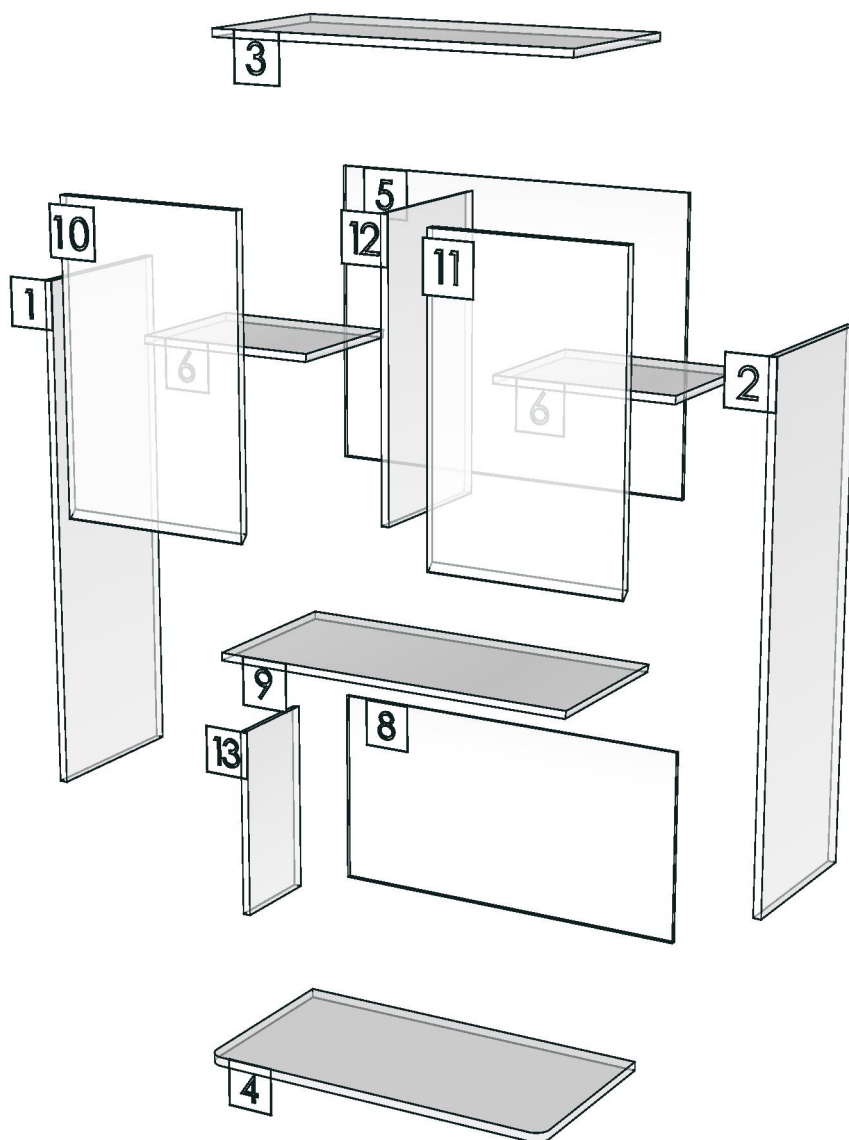

|                 |                   |                  |                    |
|-----------------|-------------------|------------------|--------------------|
| <b>Model</b>    | LIFE_CN2_D_PLT600 |                  |                    |
| <b>Creator</b>  | PASATHORN         | <b>.BCP Name</b> | INDEX_C3D_KITCHEN2 |
| <b>Reviewer</b> |                   | <b>Order</b>     | I004524            |
| <b>Approves</b> | P.SAWAI           | <b>Date</b>      | 16/10/2025         |

## LIFE\_CN2\_D\_PLT600-600X9X100

### Colour

05.38 ML MD692 (SS)\_

-

-

-

K100L-160169850

K100R-160169858

K101L-160169866

K101R-160169877

K102L-160169888

K102R-160169897

K103L-160169906

K103R-160169916

K104L-160169926

K105L-160169936

### Edge

01.286 1 MD692 \_

-

-

-

-

K113L-160169945

K113R-160169954

K114L-160169963

K114R-160169975

K115L-160169987

K115R-160169997

K116L-160170007

K116R-160170018

K117L-160170029

K118L-160170040

|                                     |                   |
|-------------------------------------|-------------------|
| <b>R&amp;D REVIEW</b>               |                   |
| <input checked="" type="checkbox"/> | DWG.Customer      |
| <input checked="" type="checkbox"/> | Work Report       |
| <input type="checkbox"/>            | Function          |
| <input type="checkbox"/>            | สินค้าตรงตัวอย่าง |
| ผู้ทบทวน <u>P.SAWAI</u>             |                   |
| <u>25/10/25</u>                     |                   |

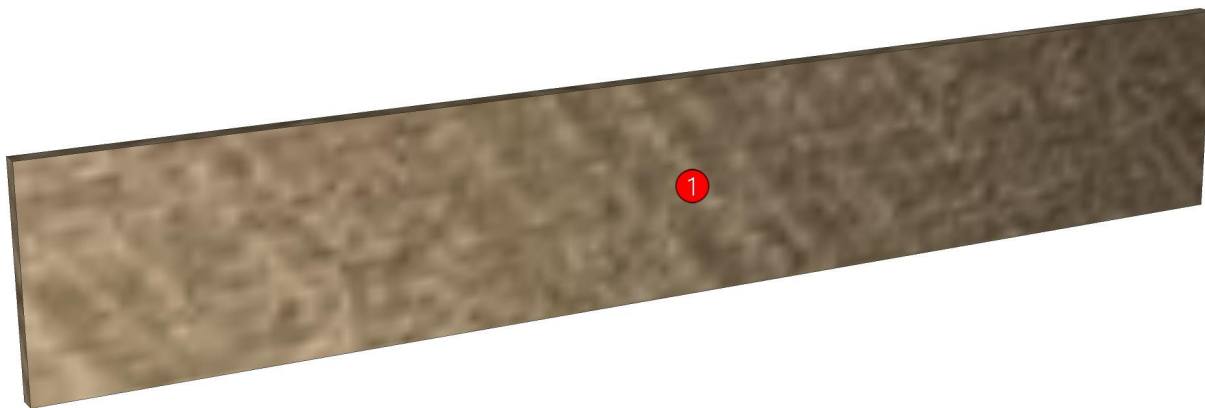

|                 |                   |                  |                    |
|-----------------|-------------------|------------------|--------------------|
| <b>Model</b>    | LIFE_CN2_D_PLT600 |                  |                    |
| <b>Creator</b>  | PASATHORN         | <b>.BCP Name</b> | INDEX_C3D_KITCHEN2 |
| <b>Reviewer</b> |                   | <b>Order</b>     | I004524            |
| <b>Approves</b> | P. SAWAI          | <b>Date</b>      | 16/10/2025         |

| No. | Article No.          | Description       | Mat   | Dimension | Cutting Size   | Typepology                     | Skin |
|-----|----------------------|-------------------|-------|-----------|----------------|--------------------------------|------|
| 0   | LIFE_CN2_D_PLT600    | LIFE_CN2_D_PLT600 |       | 600x100x9 |                |                                |      |
|     | LIFE_CN2_D_PLT600-01 | D_PLINT-SP        | PB-SP | 9x100x600 | 9X98X598;L2:W2 | 183000 _STR=05.38 _EDG=MD692-1 | 2    |

|                 |                   |                  |                    |
|-----------------|-------------------|------------------|--------------------|
| <b>Model</b>    | LIFE_CN2_D_PLT731 |                  |                    |
| <b>Creator</b>  | PASATHORN         | <b>.BCP Name</b> | INDEX_C3D_KITCHEN2 |
| <b>Reviewer</b> |                   | <b>Order</b>     | I004470            |
| <b>Approves</b> | P.SAWAI           | <b>Date</b>      | 13/10/2025         |

## **LIFE\_CN2\_D\_PLT731-731X9X100**

### **Colour**

05.38 ML MD692 (SS)\_

-

-

-

K100L-160169850

K113L-160169945

K100R-160169858

K113R-160169954

### **Edge**

01.286 1 MD692 \_

-

-

-

-

|                                     |                   |
|-------------------------------------|-------------------|
| <b>R&amp;D REVIEW</b>               |                   |
| <input checked="" type="checkbox"/> | DWG.Customer      |
| <input checked="" type="checkbox"/> | Work Report       |
| <input type="checkbox"/>            | Function          |
| <input type="checkbox"/>            | สินค้าตรงตัวอย่าง |
| ผู้ทบทวน <u>P.SAWAI</u>             |                   |
| <u>13/10/2025</u>                   |                   |

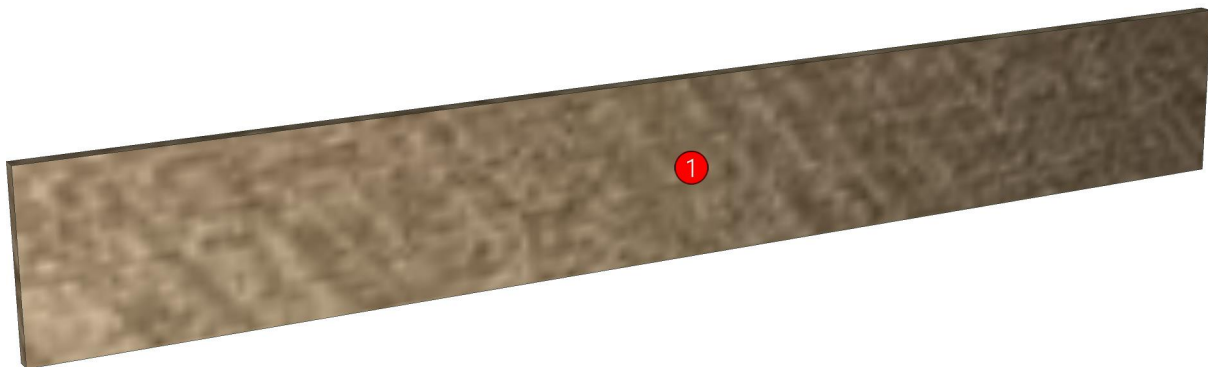

|                 |                   |                  |                    |
|-----------------|-------------------|------------------|--------------------|
| <b>Model</b>    | LIFE_CN2_D_PLT731 |                  |                    |
| <b>Creator</b>  | PASATHORN         | <b>.BCP Name</b> | INDEX_C3D_KITCHEN2 |
| <b>Reviewer</b> |                   | <b>Order</b>     | I004470            |
| <b>Approves</b> | P. SAWAI          | <b>Date</b>      | 13/10/2025         |

| No. | Article No.          | Description       | Mat   | Dimension | Cutting Size   | Typepology                     | Skin |
|-----|----------------------|-------------------|-------|-----------|----------------|--------------------------------|------|
| 0   | LIFE_CN2_D_PLT731    | LIFE_CN2_D_PLT731 |       | 731x100x9 |                |                                |      |
|     | LIFE_CN2_D_PLT731-01 | D_PLINT-SP        | PB-SP | 9x100x731 | 9X98X729;L2:W2 | 183000 _STR=05.38 _EDG=MD692-1 | 2    |