

Model	CO_RM9_DB37L		
Creator	CHALEAMPHON	.BCP Name	INDEX_C3D_KITCHEN2
Reviewer		Order	H001853
Approves		Date	10/07/2025

CO_RM9_DB37L-370X570X808

Colour

20.39=ML WARM ROVERE AJ1 (WOOD VENEER)
20.44=ML WHITE VM1012/2610/2610 (PEAEL)
03.11=PVC 0.15 WHITE SAND #DFS7T06 (MALT)

Edge

01.257=1 AJ1
01.47=1 WHITE



K23R-160169411
K57R-160170479

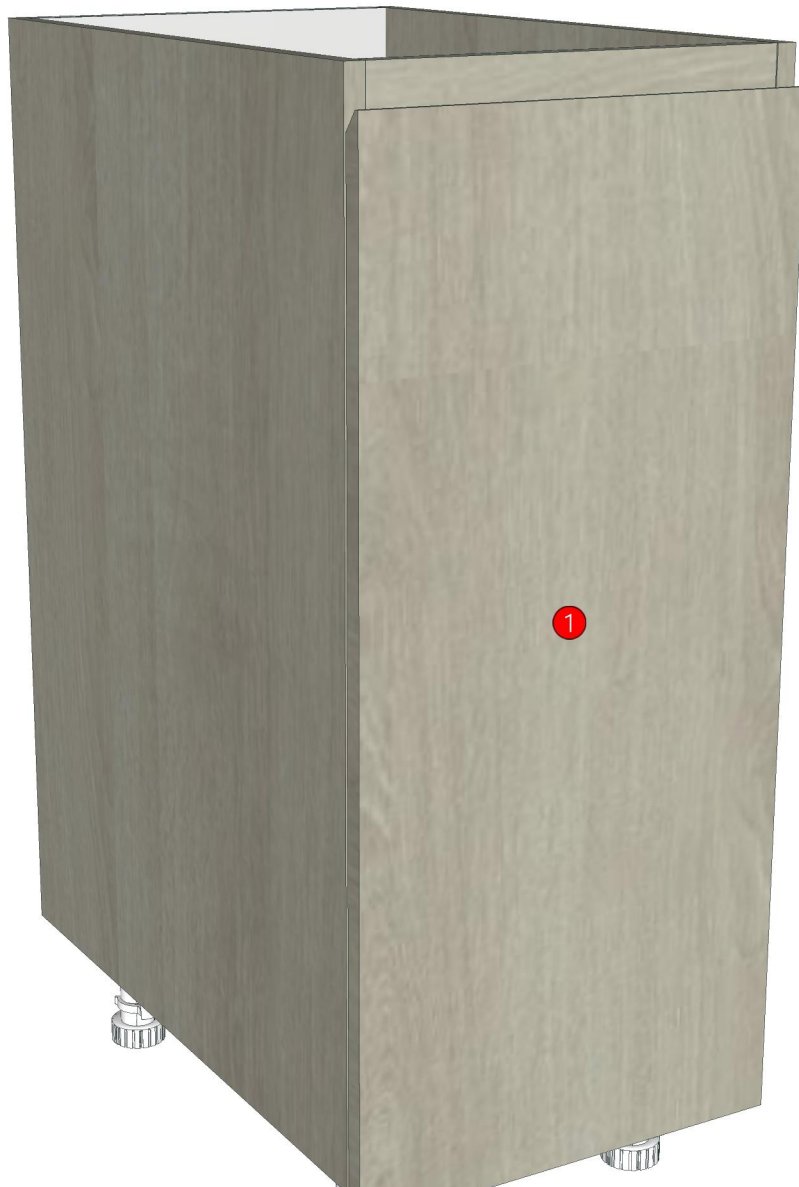

Model	-CO RM9		
Creator	CHALEAMPHON	.BCP Name	INDEX_C3D_KITCHEN2
Reviewer		Order	H001853
Approves		Date	10/07/2025

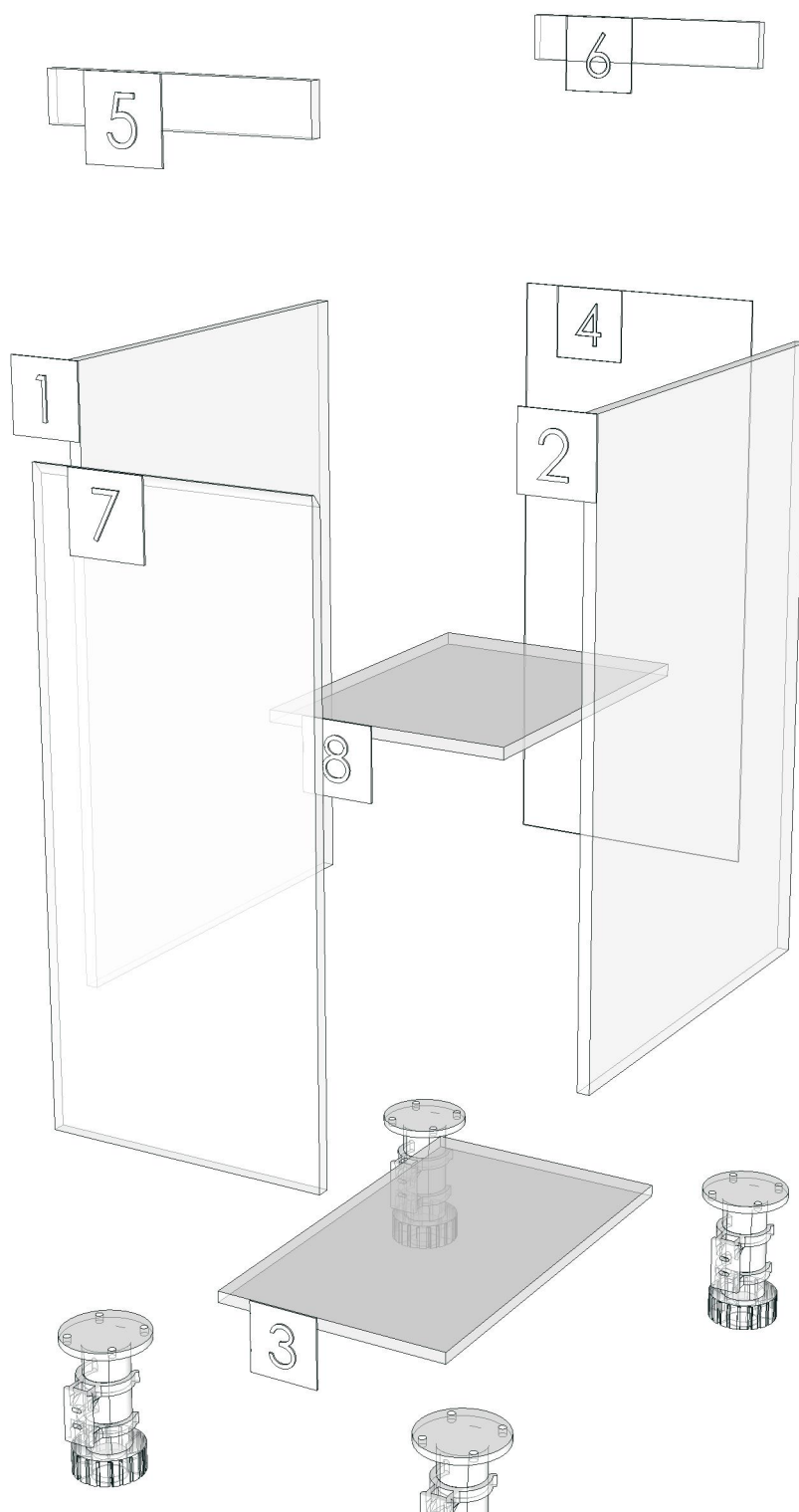

Model	CO_RM9_DBH602		
Creator	CHALEAMPHON	.BCP Name	INDEX_C3D_KITCHEN2
Reviewer		Order	H001647
Approves		Date	21/04/2025

CO_RM9_DBH602-600X570X808

Colour

20.39=ML WARM ROVERE AJ1 (WOOD VENEER)
20.44=ML WHITE VM1012/2610/2610 (PEAEL)
03.11=PVC 0.15 WHITE SAND #DFS7T06 (MALT)
06.01=TEXTURE DEAD STOCK

Edge

01.257=1 AJ1
01.47=1 WHITE

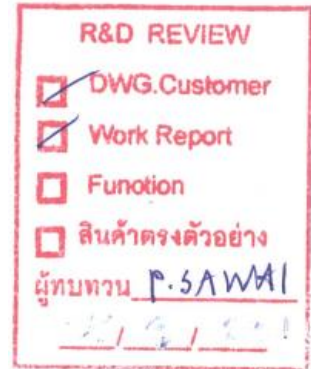

K1L-160159960
K1R-160159968
K7R-160159986
K9L-160159996
K10L-160160007
K11R-160160021
K12R-160160034
K13-160160046
K14L-160160062
K18L-160160095
K41L-160160107
K43R-160160120
K45L-160160128
K45R-160160136
K46L-160160144
K47L-160160154
K47R-160160164
K42R-160163061
K49R-160163076
K50L-160163093
K30L-160163598
K33R-160163623
K34L-160163640
K35R-160163664
K38L-160163700
K39L-160163713
K51L-160163751
K53R-160163774
K54L-160163786
K55R-160163795

K56R-160166129
K36R-160163675
K40R-160163724
K48R-160163741
K37R-160163688
K4R-160169343
K5L-160169355
K20L-160169365
K25L-160163437
K52R-160169499
K22L-160169388
K23L-160169398
K23R-160169411
K24R-160169424
K26R-160169450
K27L-160169466
K27R-160169478
K28L-160169490
K29L-160170467
K57R-160170479

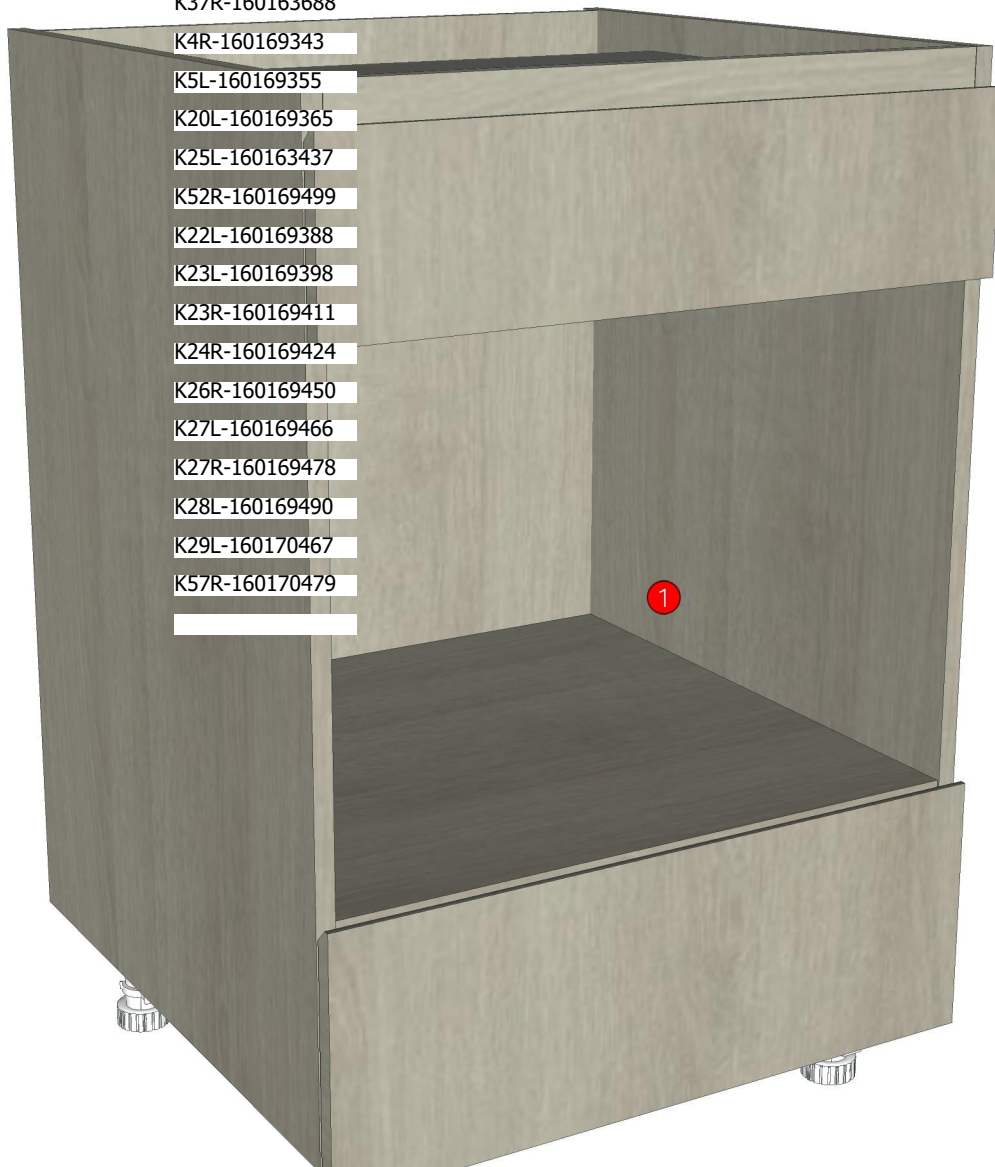

Model	-		
Creator	CHALEAMPHON	.BCP Name	INDEX_C3D_KITCHEN2
Reviewer		Order	H001647
Approves		Date	21/04/2025

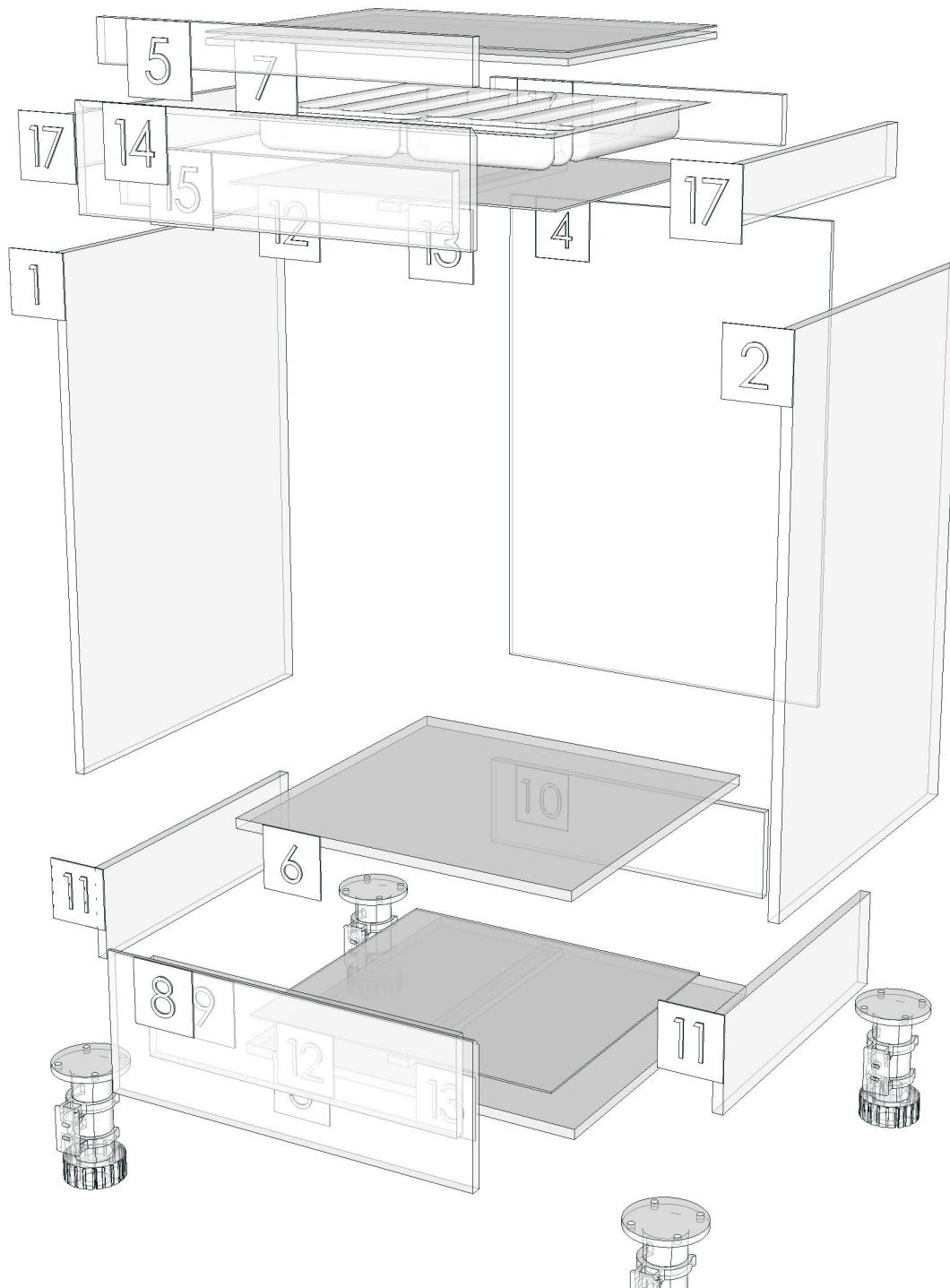

Model	CO_RM9_DBS60R		
Creator	CHALEAMPHON	.BCP Name	INDEX_C3D_KITCHEN2
Reviewer		Order	H001733
Approves		Date	24/05/2025

CO_RM9_DBS60R-600X570X808

Colour

20.39=ML WARM ROVERE AJ1 (WOOD VENEER)
20.44=ML WHITE VM1012/2610/2610 (PEAEL)
03.11=PVC 0.15 WHITE SAND #DFS7T06 (MALT)

Edge

01.257=1 AJ1
01.47=1 WHITE



K11R-160160021
K12R-160160034
K42R-160163061
K49R-160163076
K30L-160163598
K34L-160163640
K35R-160163664
K56R-160166129
K36R-160163675
K23R-160169411
K26R-160169450
K27R-160169478
K57R-160170479



Model	-CO RM9		
Creator	CHALEAMPHON	.BCP Name	INDEX_C3D_KITCHEN2
Reviewer		Order	H001733
Approves		Date	24/05/2025

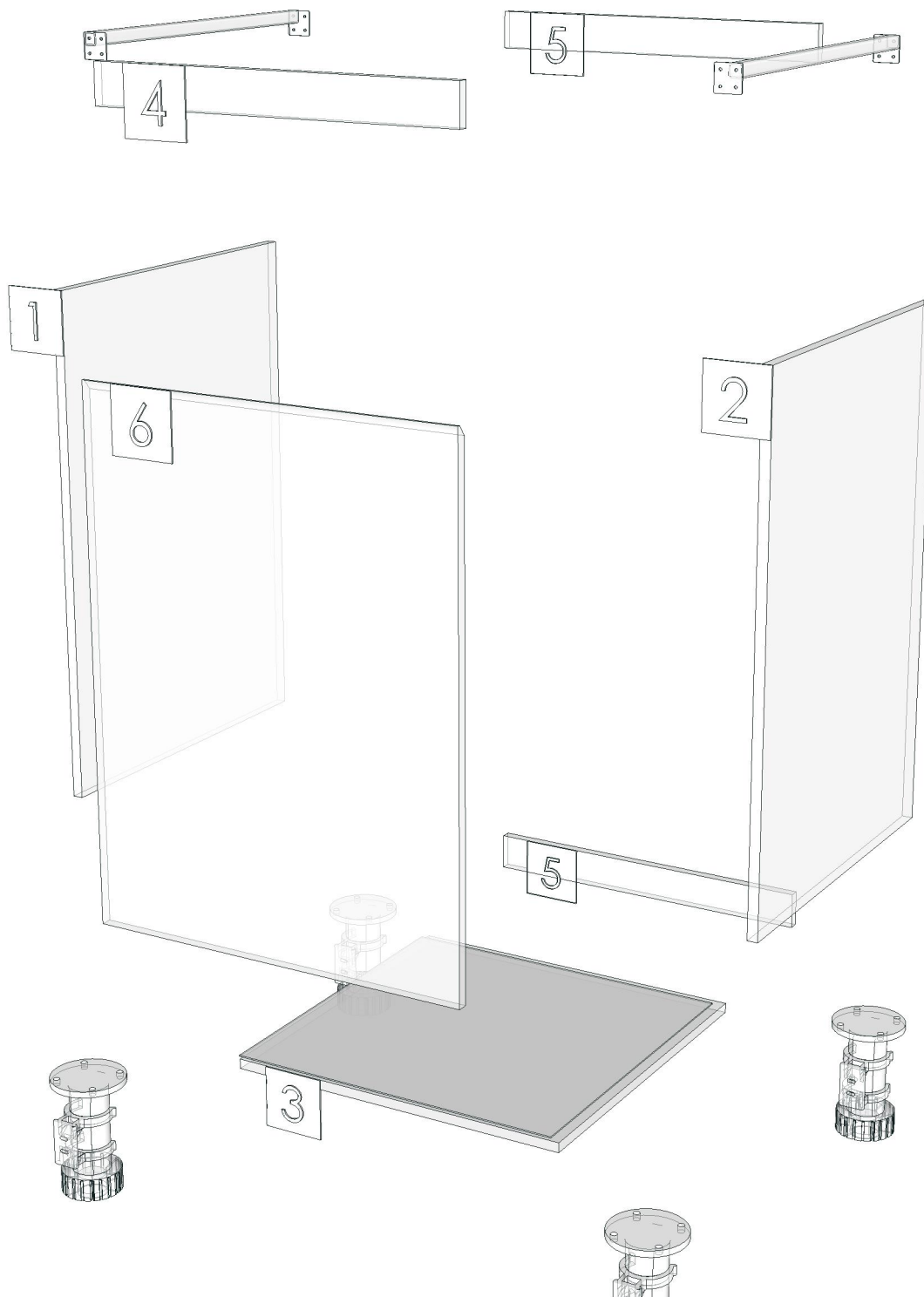

Model	CO_RM9_DFBSL		
Creator	CHALEAMPHON	.BCP Name	INDEX_C3D_KITCHEN2
Reviewer		Order	H001740
Approves		Date	27/05/2025

CO_RM9_DFBSL-150X300X908

Colour

20.39=ML WARM ROVERE AJ1 (WOOD VENEER)

Edge

01.257=1 AJ1



- K41L-160160107
- K35R-160163664
- K39L-160163713
- K25L-160169437
- K23L-160169398
- K23R-160169411
- K24R-160169424
- K57R-160170479



Model	-CO RM9		
Creator	CHALEAMPON	.BCP Name	INDEX_C3D_KITCHEN2
Reviewer		Order	H001740
Approves		Date	27/05/2025

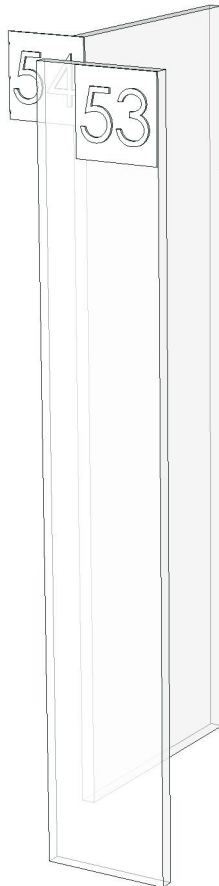

Model	CO_RM9_DFCL_1700AJ		
Creator	CHALEAMPON	.BCP Name	INDEX_C3D_KITCHEN2
Reviewer		Order	H001885
Approves		Date	23/07/2025

CO_RM9_DFCL_1700AJ-1700X9X130

Colour

20.39=ML WARM ROVERE AJ1 (WOOD VENEER)

Edge

01.257=1 AJ1

R&D REVIEW	
<input checked="" type="checkbox"/>	DWG.Customer
<input checked="" type="checkbox"/>	Work Report
<input type="checkbox"/>	Function
<input type="checkbox"/>	สินค้าตรงตัวอย่าง
ผู้ทบทวน <u>P.SAWAI</u>	
<u>23/07/2025</u>	

K25L-160169437
K23L-160169398
K23R-160169411
K57R-160170479

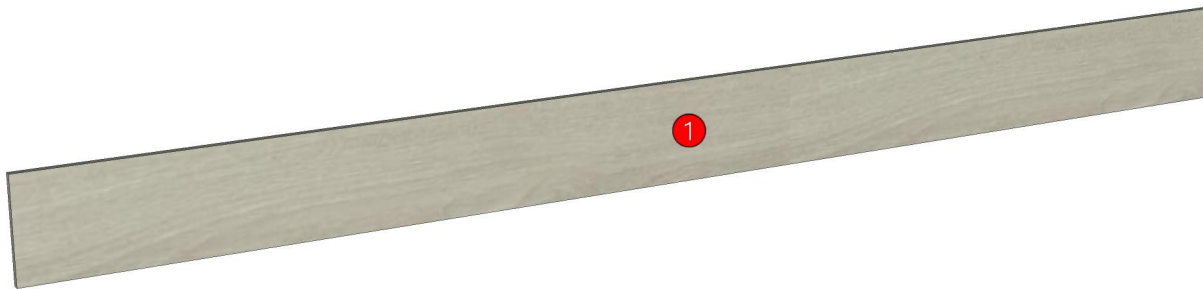

Model	CO_RM9_DFCL_1700AJ		
Creator	CHALEAMPHON	.BCP Name	INDEX_C3D_KITCHEN2
Reviewer		Order	H001885
Approves		Date	23/07/2025

No.	Article No.	Description	Mat	Dimension	Cutting Size	Typepology	Skin
0	CO_RM9_DFCL_1700AJ			1700x130x9			
	CO_RM9_DFCL_1700AJ-02	FILLER TOP	PB-ST	9x130x1700	9X129X1699;L1:W1	183000_STR=20.39_EDG=AJ1-1	2

Model	CO_RM9_DFCL_300AJ		
Creator	CHALEAMPHON	.BCP Name	INDEX_C3D_KITCHEN2
Reviewer		Order	H001751
Approves		Date	27/05/2025

CO_RM9_DFCL_300AJ-300X9X130

Colour

20.39=ML WARM ROVERE AJ1 (WOOD VENEER)

Edge

01.257=1 AJ1



- K7R-160159986
- K10L-160160007
- K12R-160160034
- K13L-160160046
- K14L-160160062
- K46L-160160144
- K47L-160160154
- K47R-160160164
- K34L-160163640
- K25L-160169437
- K22R-160169388
- K23L-160169398
- K23R-160169411
- K24R-160169424
- K26R-160169450
- K27L-160169466
- K27R-160169478
- K57R-160170479

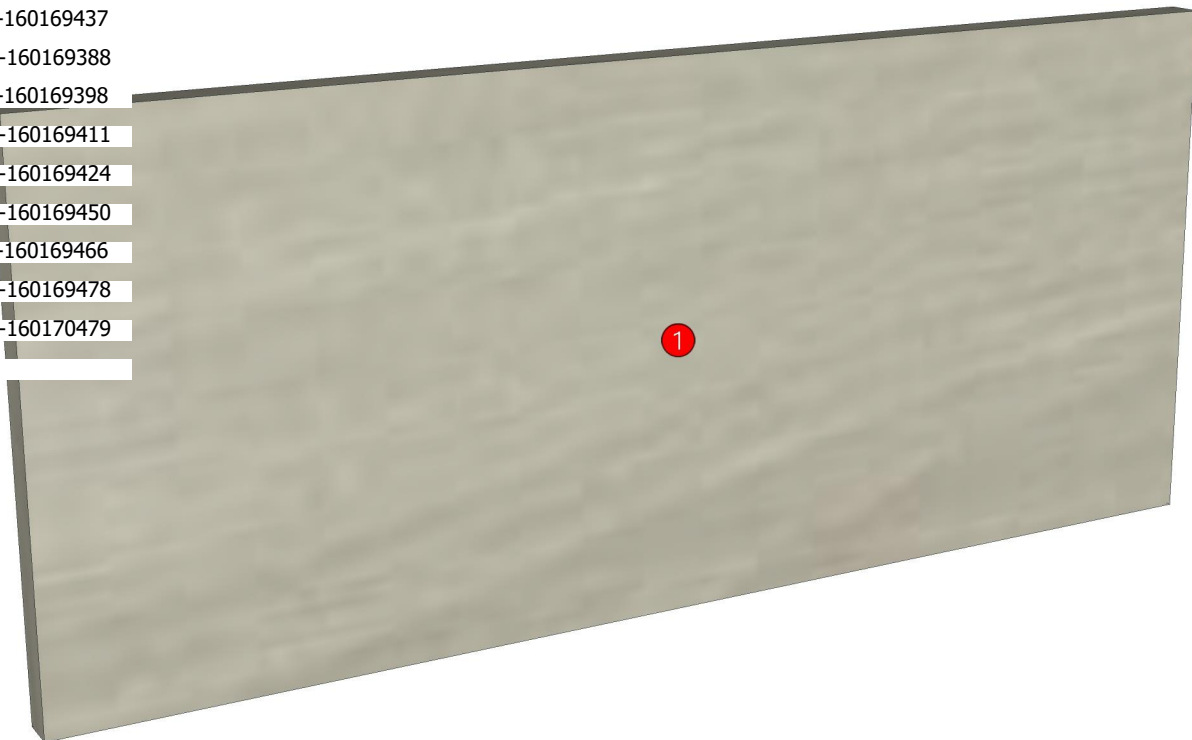

Model	CO_RM9_DFCL_300AJ		
Creator	CHALEAMPHON	.BCP Name	INDEX_C3D_KITCHEN2
Reviewer		Order	H001751
Approves		Date	27/05/2025

No.	Article No.	Description	Mat	Dimension	Cutting Size	Typepology	Skin
0	CO_RM9_DFCL_300AJ			300x130x9			
	CO_RM9_DFCL_300AJ-01	FILLER TOP	PB-ST	9x130x300	9X129X298;L1:W2	183000_STR=20.39_EDG=AJ1-1	2

Model	CO_RM9_DFCL_700AJ		
Creator	CHALEAMPON	.BCP Name	INDEX_C3D_KITCHEN2
Reviewer		Order	H001755
Approves		Date	27/05/2025

CO_RM9_DFCL_700AJ-700X9X130

Colour

20.39=ML WARM ROVERE AJ1 (WOOD VENEER)

Edge

01.257=1 AJ1

R&D REVIEW	
<input checked="" type="checkbox"/>	DWG.Customer
<input checked="" type="checkbox"/>	Work Report
<input type="checkbox"/>	Function
<input type="checkbox"/>	สินค้าตรงตัวอย่าง
ผู้ทบทวน <u>P.SAWAI</u>	
<u>27/5/25</u>	

- K10L-160160007
- K13L-160160046
- K33R-160163623
- K23L-160169398
- K23R-160169411

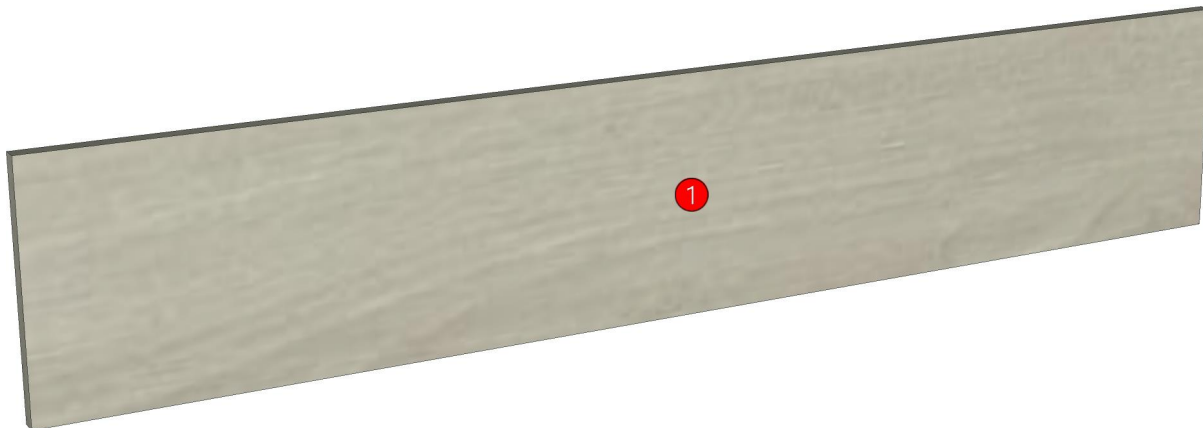

Model	CO_RM9_DFCL_700AJ		
Creator	CHALEAMPHON	.BCP Name	INDEX_C3D_KITCHEN2
Reviewer		Order	H001755
Approves		Date	27/05/2025

No.	Article No.	Description	Mat	Dimension	Cutting Size	Typepology	Skin
0	CO_RM9_DFCL_700AJ			700x130x9			
	CO_RM9_DFCL_700AJ-01	FILLER TOP	PB-ST	9x130x700	9X129X698;L1:W2	183000_STR=20.39_EDG=AJ1-1	2

Model	CO_RM9_DFCL_800AJ		
Creator	CHALEAMPHON	.BCP Name	INDEX_C3D_KITCHEN2
Reviewer		Order	H001756
Approves		Date	27/05/2025

CO_RM9_DFCL_800AJ-800X9X130

Colour

20.39=ML WARM ROVERE AJ1 (WOOD VENEER)

Edge

01.257=1 AJ1



- K13L-160160046
- K15L-160160073
- K30L-160163598
- K23L-160169398
- K23R-160169411

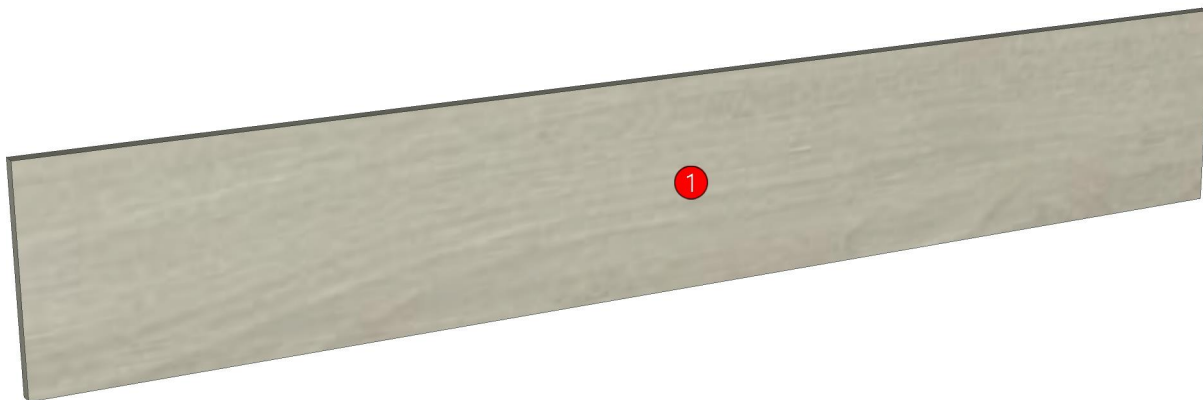

Model	CO_RM9_DFCL_800AJ		
Creator	CHALEAMPHON	.BCP Name	INDEX_C3D_KITCHEN2
Reviewer		Order	H001756
Approves		Date	27/05/2025

No.	Article No.	Description	Mat	Dimension	Cutting Size	Typepology	Skin
0	CO_RM9_DFCL_800AJ			800x130x9			
	CO_RM9_DFCL_800AJ-01	FILLER TOP	PB-ST	9x130x800	9X129X798;L1:W2	183000_STR=20.39_EDG=AJ1-1	2

Model	CO_RM9_DFL(AJ)		
Creator	CHALEAMPHON	.BCP Name	INDEX_C3D_KITCHEN2
Reviewer		Order	H001785
Approves		Date	04/06/2025

CO_RM9_DFL(AJ)-150X300X700

Colour

05.96=ML.WHITE NORDIC ELM BS9 (MATT WOODGRAIN)

20.39=ML WARM ROVERE AJ1 (WOOD VENEER)

Edge

01.366=1 BS9

01.257=1 AJ1



- K7R-160159986
- K10L-160160007
- K11R-160160021
- K13L-160160046
- K35R-160163664
- K25L-160169437
- K23L-160169398
- K23R-160169411
- K24R-160169424
- K26R-160169450
- K57R-160170479

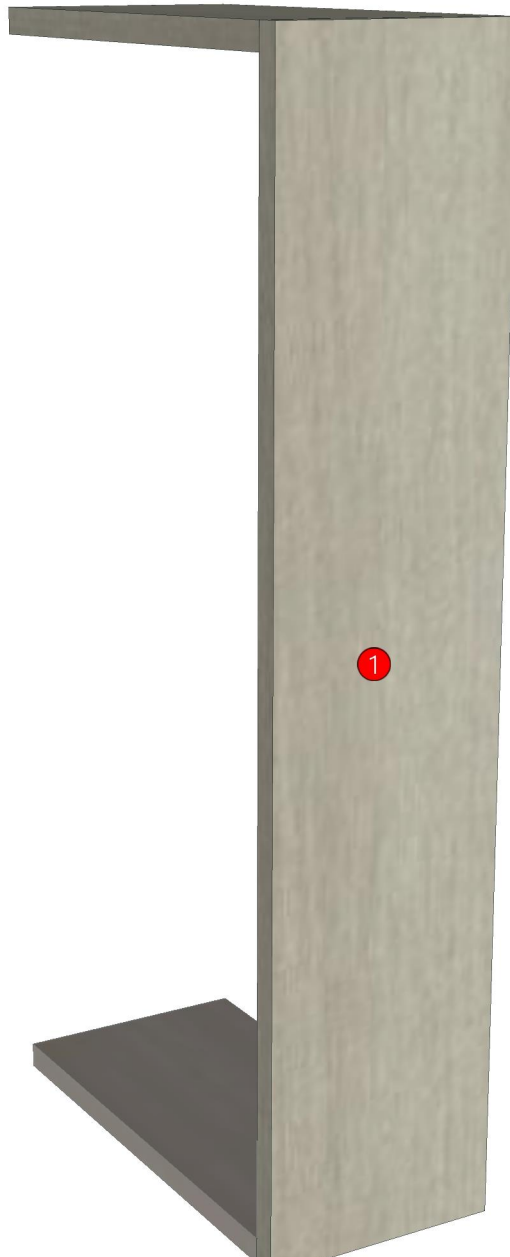

Model	-CO RM9		
Creator	CHALEAMPON	.BCP Name	INDEX_C3D_KITCHEN2
Reviewer		Order	H001785
Approves		Date	04/06/2025

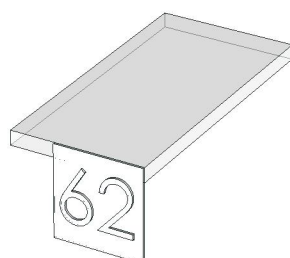
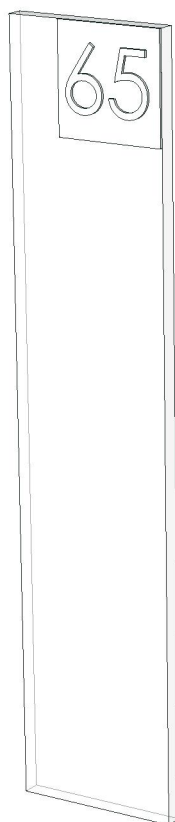
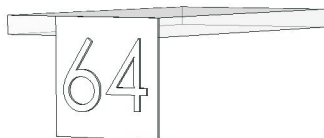

Model	CO_RM9_DFW(AJ)		
Creator	CHALEAMPHON	.BCP Name	INDEX_C3D_KITCHEN2
Reviewer		Order	H001786
Approves		Date	05/06/2025

CO_RM9_DFW(AJ)-150X300X400

Colour

05.96=ML.WHITE NORDIC ELM BS9 (MATT WOODGRAIN)

20.39=ML WARM ROVERE AJ1 (WOOD VENEER)

Edge

01.366=1 BS9

01.257=1 AJ1



K15L-160160073
K25L-160169437
K23L-160169398
K23R-160169411
K57R-160170479

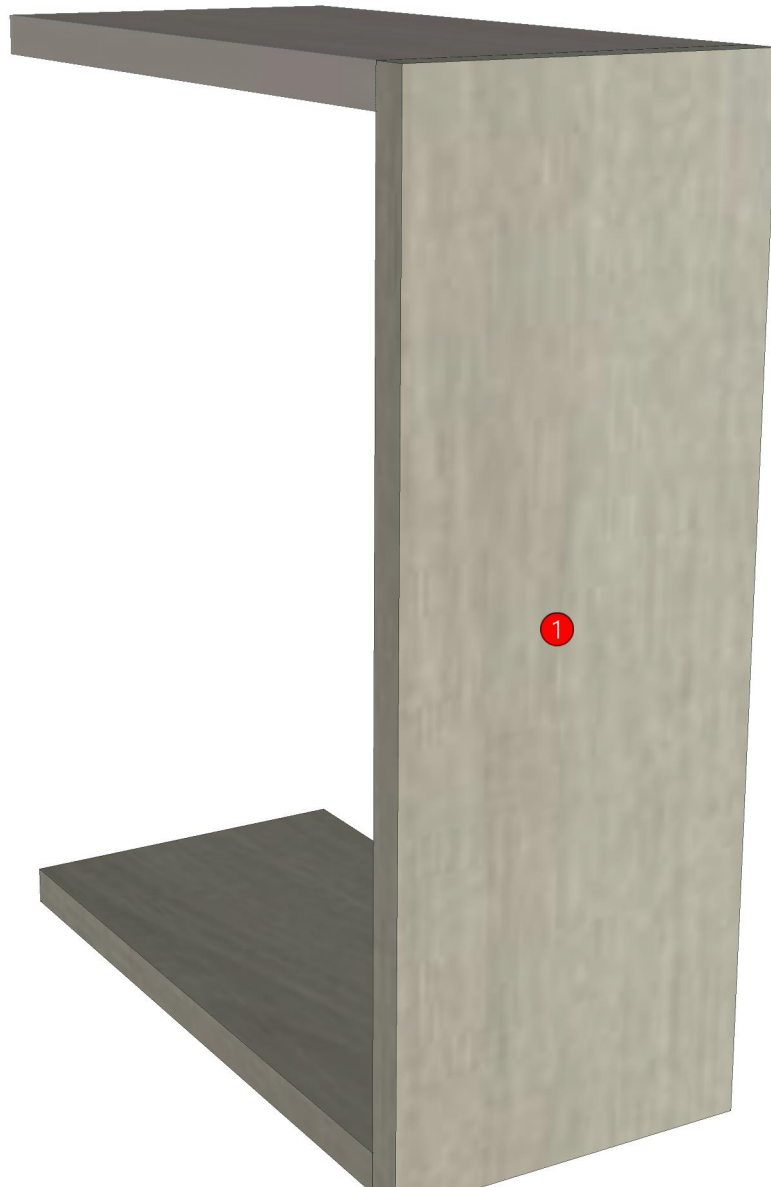

Model	-CO RM9		
Creator	CHALEAMPON	.BCP Name	INDEX_C3D_KITCHEN2
Reviewer		Order	H001786
Approves		Date	05/06/2025

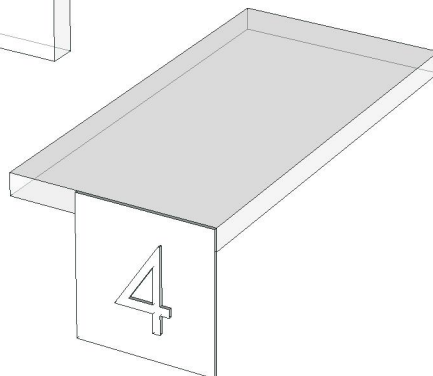
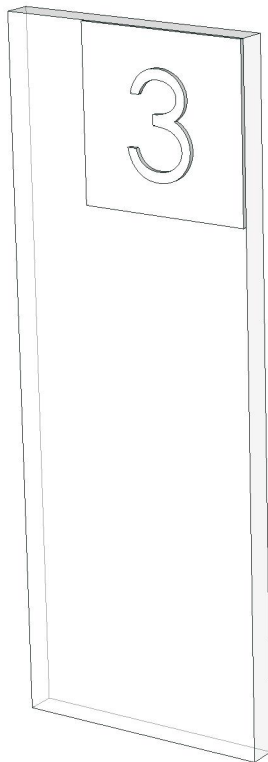
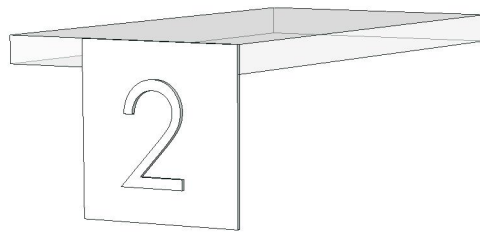

Model	CO_RM9_DL37L		
Creator	CHALEAMPHON	.BCP Name	INDEX_C3D_KITCHEN2
Reviewer		Order	H001674
Approves		Date	06/05/2025

CO_RM9_DL37L-370X300X700

Colour

05.96=ML.WHITE NORDIC ELM BS9 (MATT WOODGRAIN)

20.44=ML WHITE VM1012/2610/2610 (PEAEL)

03.11=PVC 0.15 WHITE SAND #DFS7T06 (MALT)

Edge

01.366=1 BS9

01.47=1 WHITE



K23R-160169411

K57R-160170479

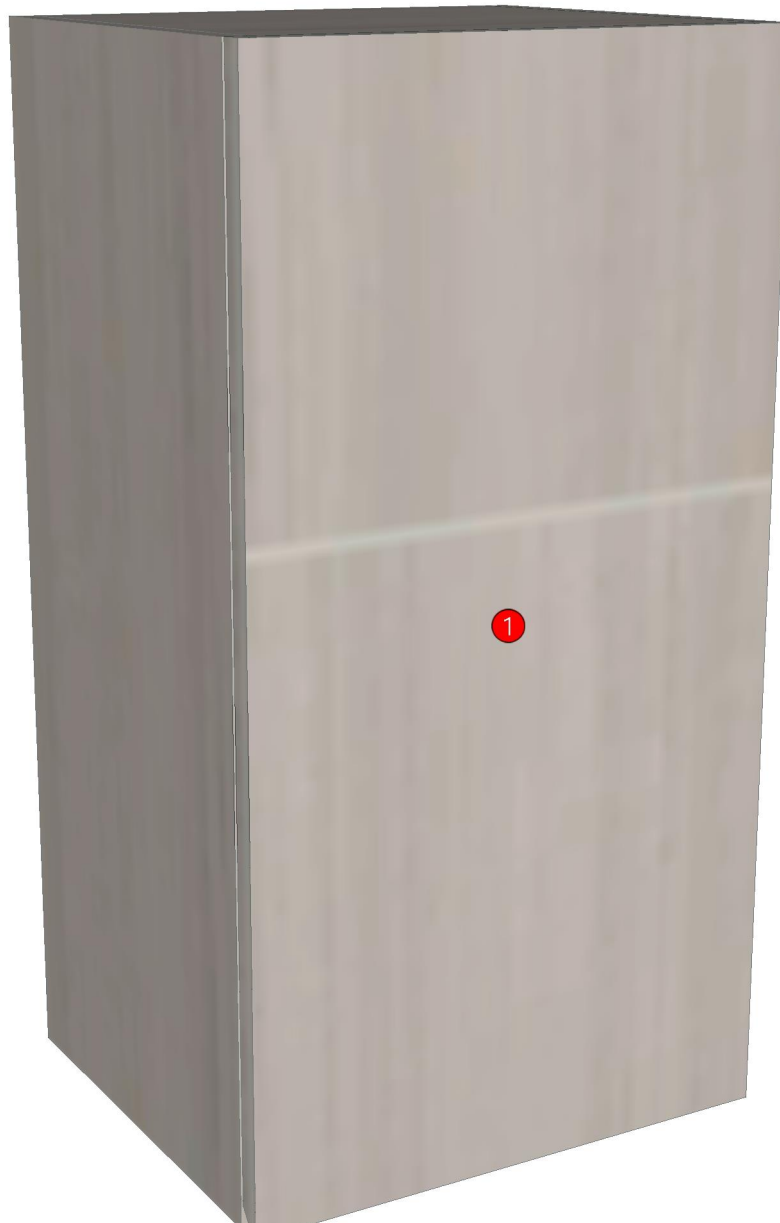

Model	-CO RM9		
Creator	CHALEAMPHON	.BCP Name	INDEX_C3D_KITCHEN2
Reviewer		Order	H001674
Approves		Date	06/05/2025

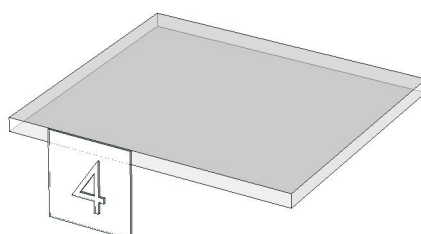
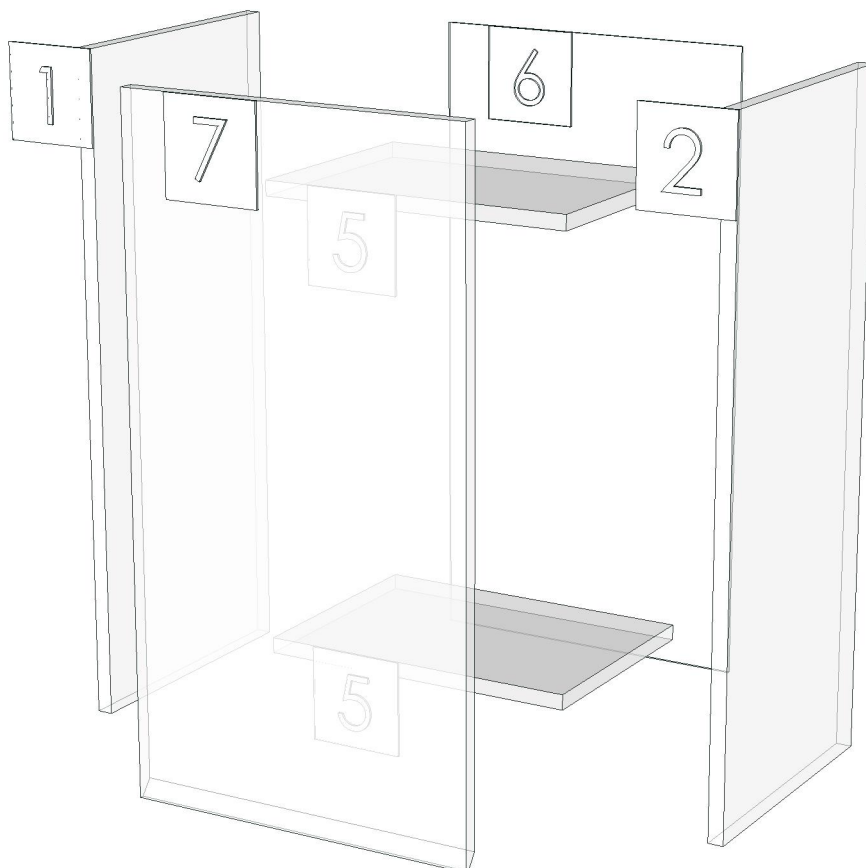
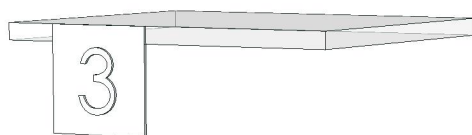

Model	CO_RM9_DL60HL		
Creator	CHALEAMPHON	.BCP Name	INDEX_C3D_KITCHEN2
Reviewer		Order	H001651
Approves		Date	23/04/2025

CO_RM9_DL60HL-600X300X660

Colour

05.96=ML.WHITE NORDIC ELM BS9 (MATT WOODGRAIN)

20.44=ML WHITE VM1012/2610/2610 (PEAEL)

03.11=PVC 0.15 WHITE SAND #DFS7T06 (MALT)

Edge

01.366=1 BS9

01.47=1 WHITE



K1R-160159968
K7R-160159986
K11R-160160021
K12R-160160034
K43R-160160120
K45R-160160136
K47R-160160164
K35R-160163664
K53R-160163774
K55R-160163795
K48R-160163741
K52R-160169499
K22R-160169388
K23R-160169411
K24R-160169424
K26R-160169450
K27R-160169478
K57R-160170479



Model	-CO RM9		
Creator	CHALEAMPON	.BCP Name	INDEX_C3D_KITCHEN2
Reviewer		Order	H001651
Approves		Date	23/04/2025

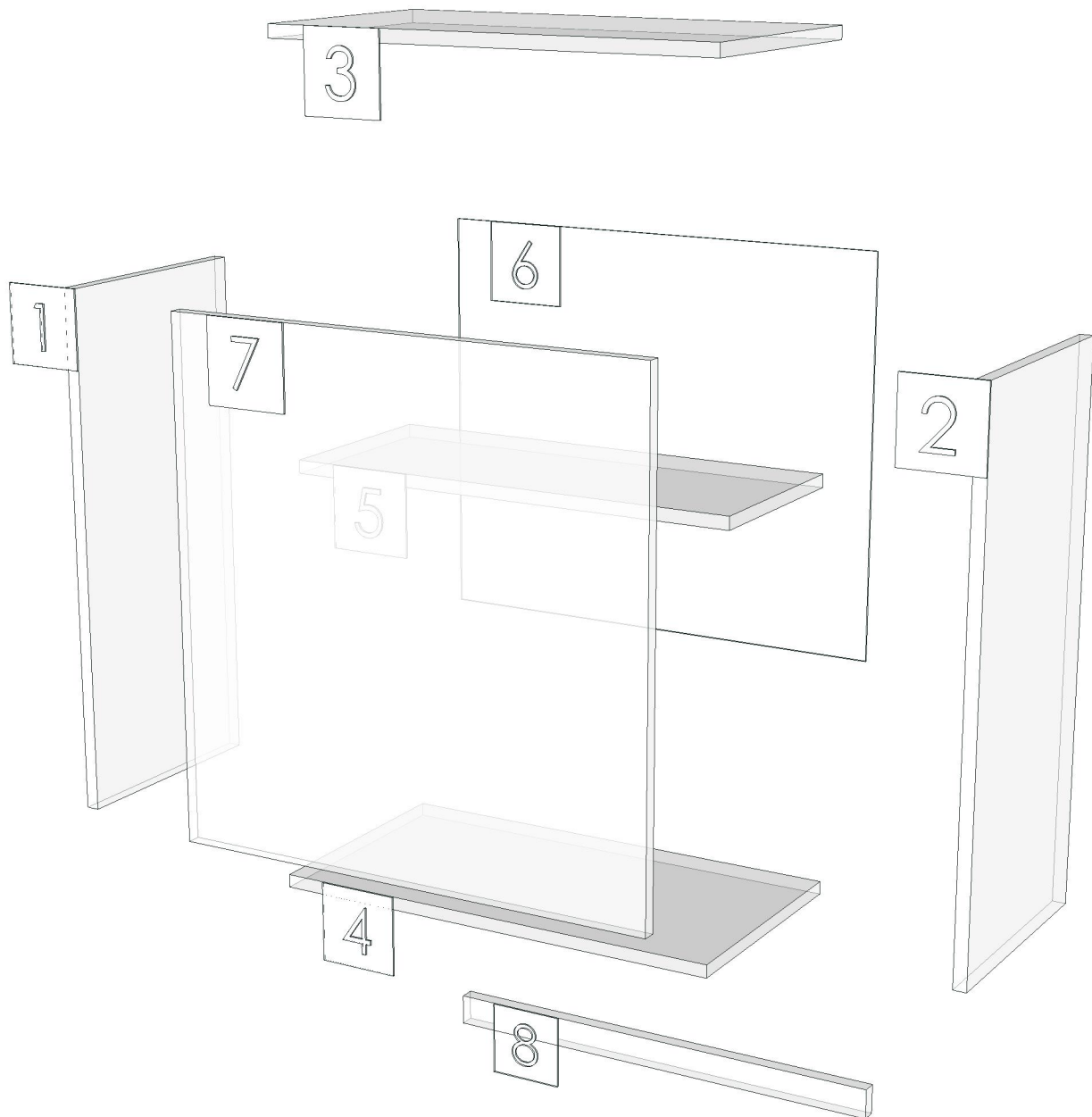

Model	CO_RM9_DL60R		
Creator	CHALEAMPHON	.BCP Name	INDEX_C3D_KITCHEN2
Reviewer		Order	H001650
Approves		Date	23/04/2025

CO_RM9_DL60R-600X300X700

Colour

05.96=ML.WHITE NORDIC ELM BS9 (MATT WOODGRAIN)

20.44=ML WHITE VM1012/2610/2610 (PEAEL)

03.11=PVC 0.15 WHITE SAND #DFS7T06 (MALT)

Edge

01.366=1 BS9

01.47=1 WHITE

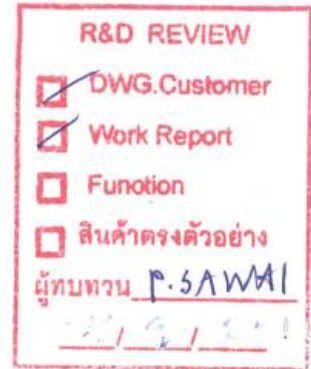

- K1R-160159968
- K11L-160160021
- K12R-160160034
- K14L-160160062
- K43R-160160120
- K45R-160160136
- K42R-160163061
- K49R-160163076
- K56R-160166129
- K36R-160163675
- K40R-160163724
- K48R-160163741
- K37R-160163688
- K20L-160169365
- K23R-160169411
- K27R-160169478
- K57R-160170479



Model	-CO RM9		
Creator	CHALEAMPON	.BCP Name	INDEX_C3D_KITCHEN2
Reviewer		Order	H001650
Approves		Date	23/04/2025

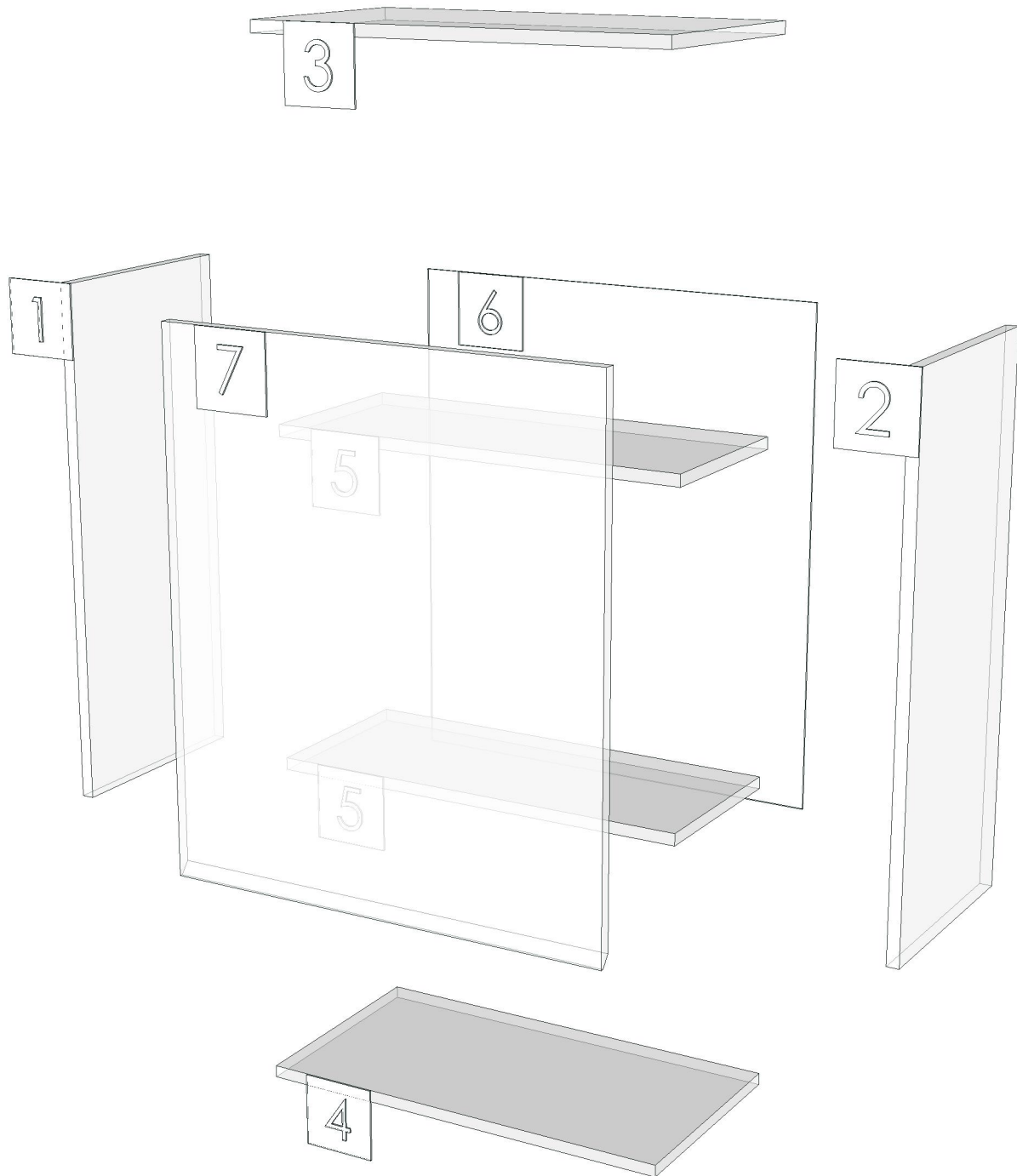

Model	CO_RM9_DPLT_1570		
Creator	CHALEAMPON	.BCP Name	INDEX_C3D_KITCHEN2
Reviewer		Order	H001898
Approves		Date	23/07/2025

CO_RM9_DPLT_1570-1570X9X100

Colour

20.39=ML WARM ROVERE AJ1 (WOOD VENEER)

Edge

01.257=1 AJ1



K25L-160169437
K23L-160169398
K23R-160169411
K57R-160170479

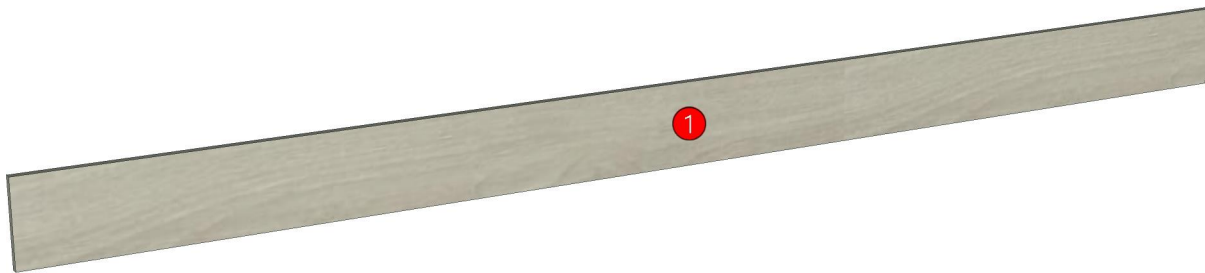

Model	CO_RM9_DPLT_1570		
Creator	CHALEAMPHON	.BCP Name	INDEX_C3D_KITCHEN2
Reviewer		Order	H001898
Approves		Date	23/07/2025

No.	Article No.	Description	Mat	Dimension	Cutting Size	Typepology	Skin
0	CO_RM9_DPLT_1570			1570x100x9			
	CO_RM9_DPLT_1570-01	LED BOTTOM	PB-ST	9x100x1570	9X98X1568;L2:W2	183000_STR=20.39_EDG=AJ1-1	2

Model	CO_RM9_DPLT_600		
Creator	CHALEAMPHON	.BCP Name	INDEX_C3D_KITCHEN2
Reviewer		Order	H001601
Approves		Date	06/03/2025

CO_RM9_DPLT_600-600X9X100

Colour

20.39=ML WARM ROVERE AJ1 (WOOD VENEER)

Edge

01.257=1 AJ1



- | | |
|----------------|----------------|
| K1L-160159960 | K54L-160163786 |
| K1R-160159968 | K56R-160166129 |
| K2R-160159976 | K55R-160163795 |
| K7R-160159986 | K36R-160163675 |
| K9L-160159996 | K40R-160163724 |
| K10L-160160007 | K48R-160163741 |
| K11R-160160021 | K37R-160163688 |
| K12R-160160034 | K4R-160169343 |
| K14L-160160062 | K5L-160169355 |
| K15L-160160073 | K20L-160169365 |
| K16R-160160085 | K25L-160169437 |
| K18L-160160095 | K52R-160169499 |
| K41L-160160107 | K22L-160169388 |
| K43R-160160120 | K23L-160169398 |
| K45L-160160128 | K23R-160169411 |
| K45R-160160136 | K24R-160169424 |
| K46L-160160144 | K26R-160169450 |
| K47L-160160154 | K27L-160169466 |
| K47R-160160164 | K27R-160169478 |
| K42R-160163061 | K28L-160169490 |
| K49R-160163076 | K29L-160170467 |
| K50L-160163093 | K57R-160170479 |
| K30L-160163598 | |
| K33R-160163623 | |
| K34L-160163640 | |
| K35R-160163664 | |
| K38L-160163700 | |
| K39L-160163713 | |
| K51L-160163751 | |
| K53R-160163774 | |

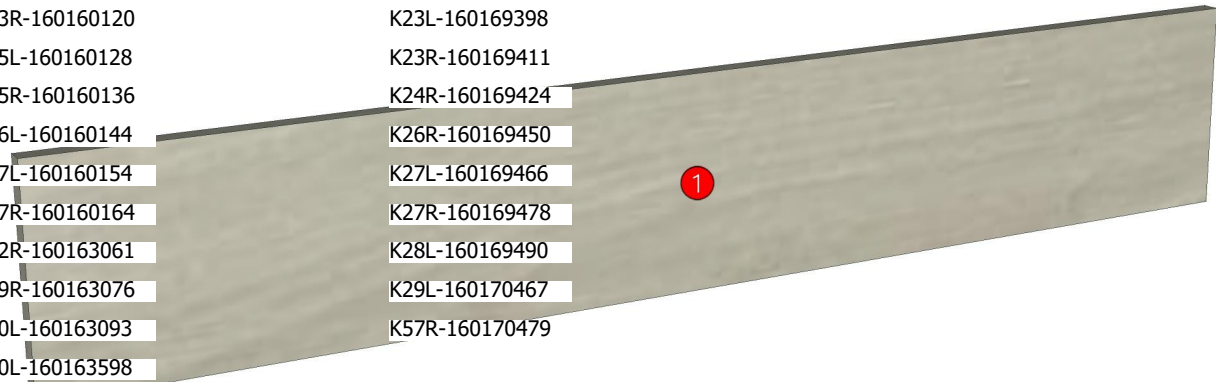

Model	CO_RM9_DPLT_600		
Creator	CHALEAMPHON	.BCP Name	INDEX_C3D_KITCHEN2
Reviewer		Order	H001601
Approves		Date	06/03/2025

No.	Article No.	Description	Mat	Dimension	Cutting Size	Typepology	Skin
0	CO_RM9_DPLT_600			600x100x9			
	CO_RM9_DPLT_600-01	LED BOTTOM	PB-ST	9x100x600	9X98X598;L2:W2	183000_STR=20.39_EDG=AJ1-1	2

Model	CO_RM9_DT60(C)L		
Creator	CHALEAMPON	.BCP Name	INDEX_C3D_KITCHEN2
Reviewer		Order	H002018
Approves		Date	22/09/2025

CO_RM9_DT60(C)L-600X300X2220

Colour

20.39=ML WARM ROVERE AJ1 (WOOD VENEER)
05.96=ML.WHITE NORDIC ELM BS9 (MATT WOODGRAIN)
20.44=ML WHITE VM1012/2610/2610 (PEAEL)
03.11=PVC 0.15 WHITE SAND #DFS7T06 (MALT)

Edge

01.257=1 AJ1
01.366=1 BS9
01.47=1 WHITE



K23R-160169411



Model	-		
Creator	CHALEAMPHON	.BCP Name	INDEX_C3D_KITCHEN2
Reviewer		Order	H002018
Approves		Date	22/09/2025

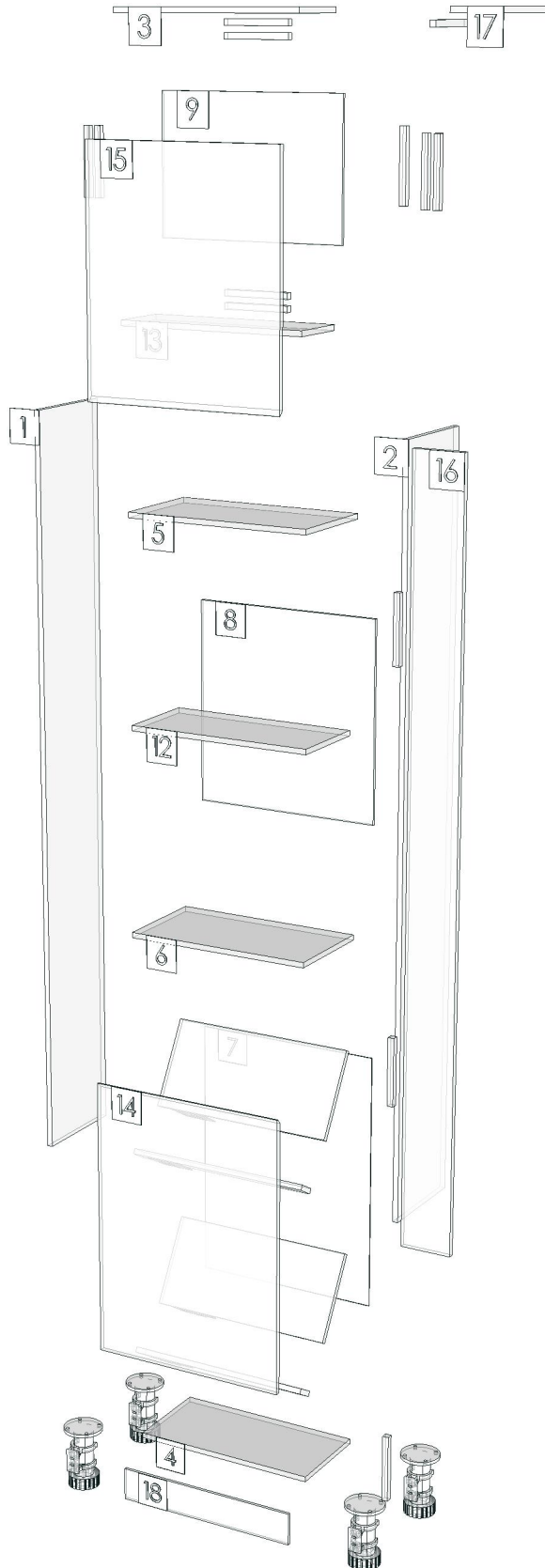

Model	CO_RM9_DW80(S)		
Creator	CHALEAMPON	.BCP Name	INDEX_C3D_KITCHEN2
Reviewer		Order	H002020
Approves		Date	22/09/2025

CO_RM9_DW80(S)-800X300X400

Colour

05.96=ML.WHITE NORDIC ELM BS9 (MATT WOODGRAIN)

20.39=ML WARM ROVERE AJ1 (WOOD VENEER)

03.11=PVC 0.15 WHITE SAND #DFS7T06 (MALT)

Edge

01.366=1 BS9

01.257=1 AJ1



K23L-160169398

K23R-160169411

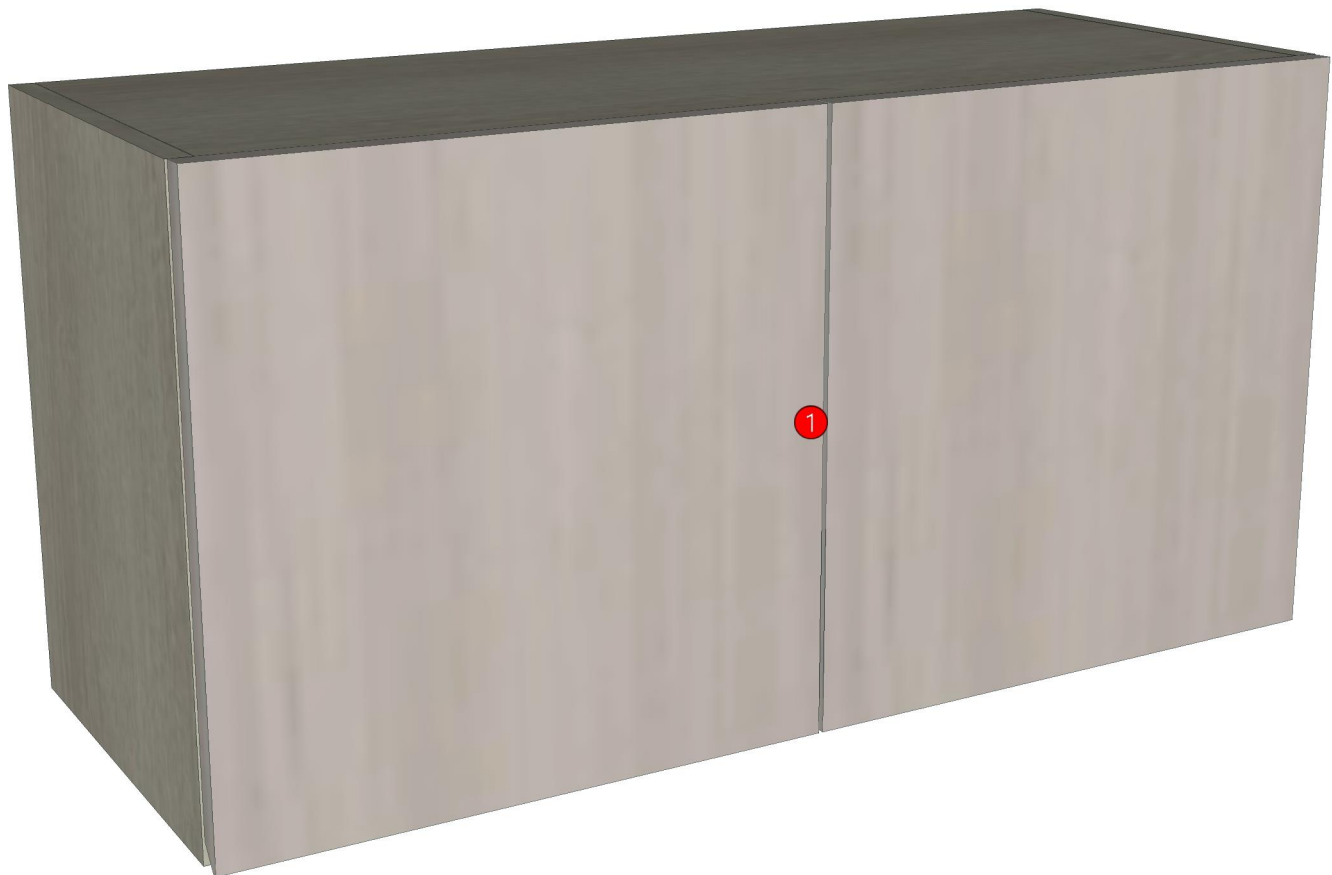

Model	-		
Creator	CHALEAMPON	.BCP Name	INDEX_C3D_KITCHEN2
Reviewer		Order	H002020
Approves		Date	22/09/2025

