

Model	RHYTHM_CN_DBS55R(L)	.BCP Name	INDEX_C3D_KITCHEN2
Creator	CHALEAMPON	Order	H001797
Reviewer		Date	14/06/2025
Approves	P.SAWMI		

## RHYTHM\_CN\_DBS55R(L)-550X570X785

### Colour

05.68=ML.BROWN NORDIC#BT1 (MATT WOODGRAIN)

20.04=ML.SANDSTONE#073 \_PEARL

### Edge

01.381=1 ML.BROWN NORDIC BT1

01.155=1 SANDSTONE (P7-500M1)

<b>R&amp;D REVIEW</b>	
<input checked="" type="checkbox"/>	DWG.Customer
<input checked="" type="checkbox"/>	Work Report
<input type="checkbox"/>	Function
<input type="checkbox"/>	สินค้าตรงตัวอย่าง
ผู้ตรวจ P.SAWMI	
9 / 10 / 2025	

K1005R-160168989



PRODUCT SIZE DRAWING :550 X D570 X H785

PAGE 1

<b>Model</b>	-RHYTHM_CN	<b>.BCP Name</b>	INDEX_C3D_KITCHEN2
<b>Creator</b>	CHALEAMPHON	<b>Order</b>	H001797
<b>Reviewer</b>		<b>Date</b>	14/06/2025
<b>Approves</b>	P. JAWA		

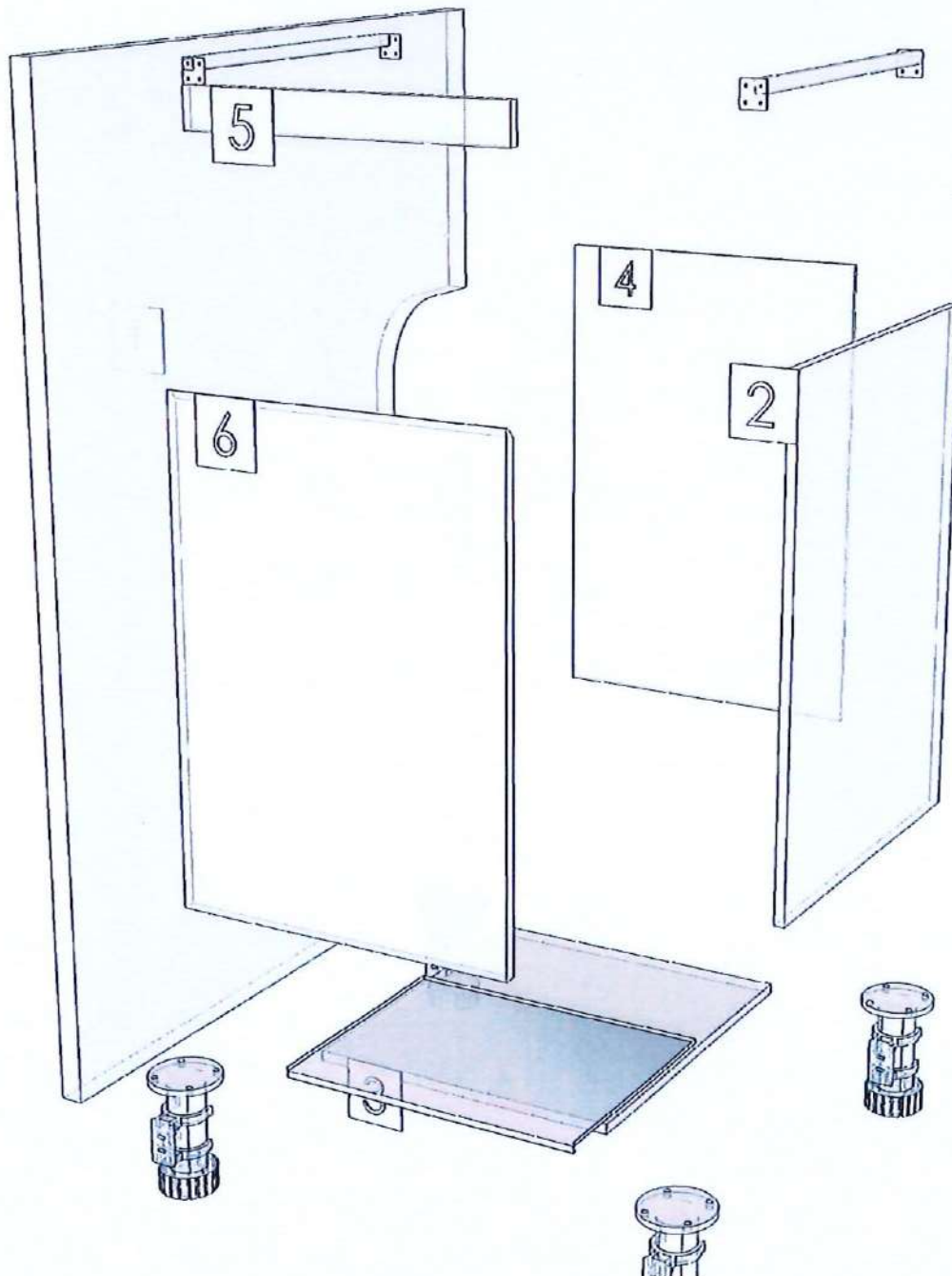

<b>Model</b>	RHYTHM_CN_DBS55R(L)		
<b>Creator</b>	CHALEAMPHON	<b>.BCP Name</b>	INDEX_C3D_KITCHEN2
<b>Reviewer</b>		<b>Order</b>	H001797
<b>Approves</b>	M. SAWAI	<b>Date</b>	14/06/2025

No.	Article No.	Description	Mat	Dimension	Cutting Size	Typeology	Skin
0	RHYTHM_CN_DBS55R(L)			550x785x570			
	RHYTHM_CN_DBS55R(L) 01	LEFT	FB-ST	16x570x785	16X568X783;L2:W2	181000_STR-05 68 _EDG-BTI-1	2
	RHYTHM_CN_DBS55R(L) 02	RIGHT	FB-ST	16x570x785	16X568X783;L2:W2	181001_STR-05 68 _EDG-BTI-1	2
	RHYTHM_CN_DBS55R(L) 03	BOTTOM	FB-ST	16x570x517	16X568X517;L2:W0	182000_STR-05 68 _EDG-BTI-1	2
	RHYTHM_CN_DBS55R(L) 04	BACK.SP	FB-ST	9x526x772	9X526X772;NO EDGE	186000_STR-20 04 _EDG--	2
	RHYTHM_CN_DBS55R(L) 05	BEAM FRONT	FB-ST	16x60x517	16X58X517;L2:W0	183000_STR-05 68 _EDG-BTI-1	2
	RHYTHM_CN_DBS55R(L) 06	DOOR R_SF(V1)	FB-ST	19x547x755	19X545X753;L2:W2	186001_STR-05 68 _EDG-BTI-1	2

Model	RHYTHM_CN_DBH602(LR)		
Creator	CHALEAMPHON	.BCP Name	INDEX_C3D_KITCHEN2
Reviewer		Order	H001795
Approves	<i>P.SAWAI</i>	Date	14/06/2025

## **RHYTHM\_CN\_DBH602(LR)-600X570X785**

**Colour**

05.68=ML.BROWN NORDIC#BT1 (MATT WOODGRAIN)

20.04=ML.SANDSTONE#073\_PEARL

**Edge**

01.381=1 ML.BROWN NORDIC BT1

01.155=1 SANDSTONE (P7-500M1)

<b>R&amp;D REVIEW</b>	
<input checked="" type="checkbox"/>	DWG.Customer
<input checked="" type="checkbox"/>	Work Report
<input type="checkbox"/>	Function
<input type="checkbox"/>	สินค้าตรงตัวอย่าง
ผู้ตรวจ <i>P.SAWAI</i>	
<i>9 / 10 / 2025</i>	

K1005L-160168970

K1005R-160168989

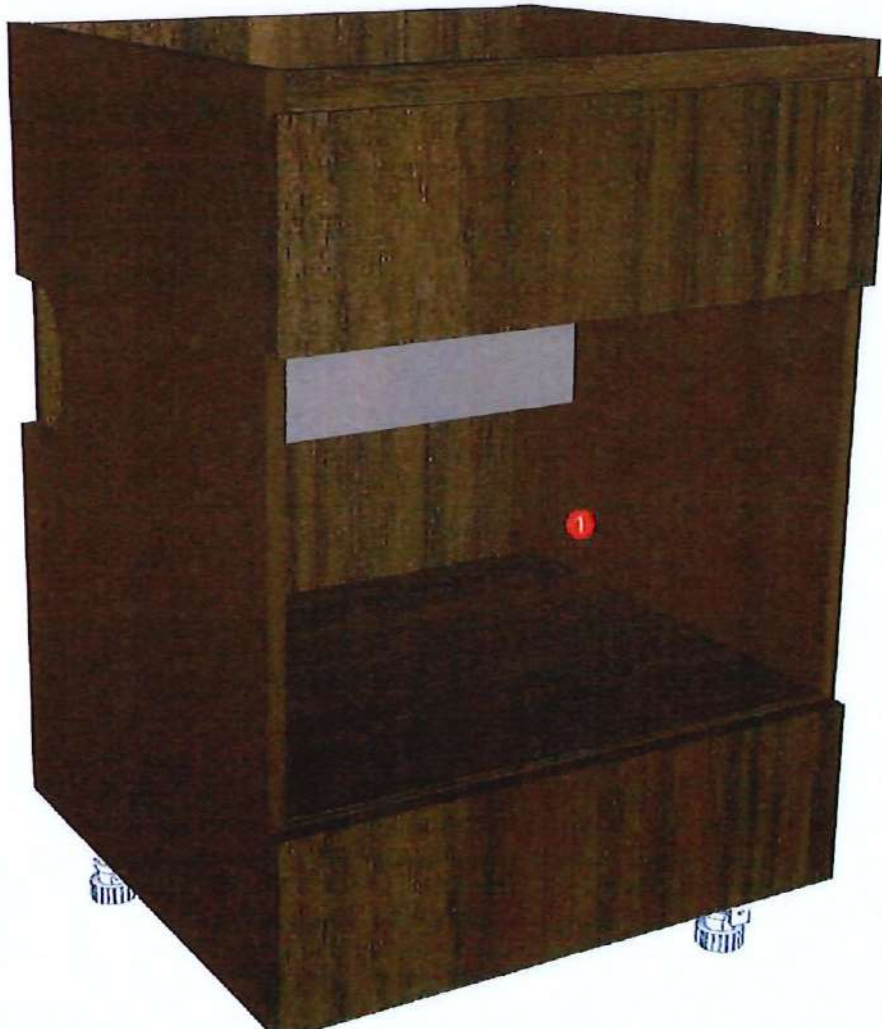

PRODUCT SIZE DRAWING :600 X D570 X H785

PAGE 1

Model	-RHYTHM_CN	.BCP Name	INDEX_C3D_KITCHEN2
Creator	CHALEAMPON	Order	H001795
Reviewer		Date	14/06/2025
Approves	P. JAWAI		

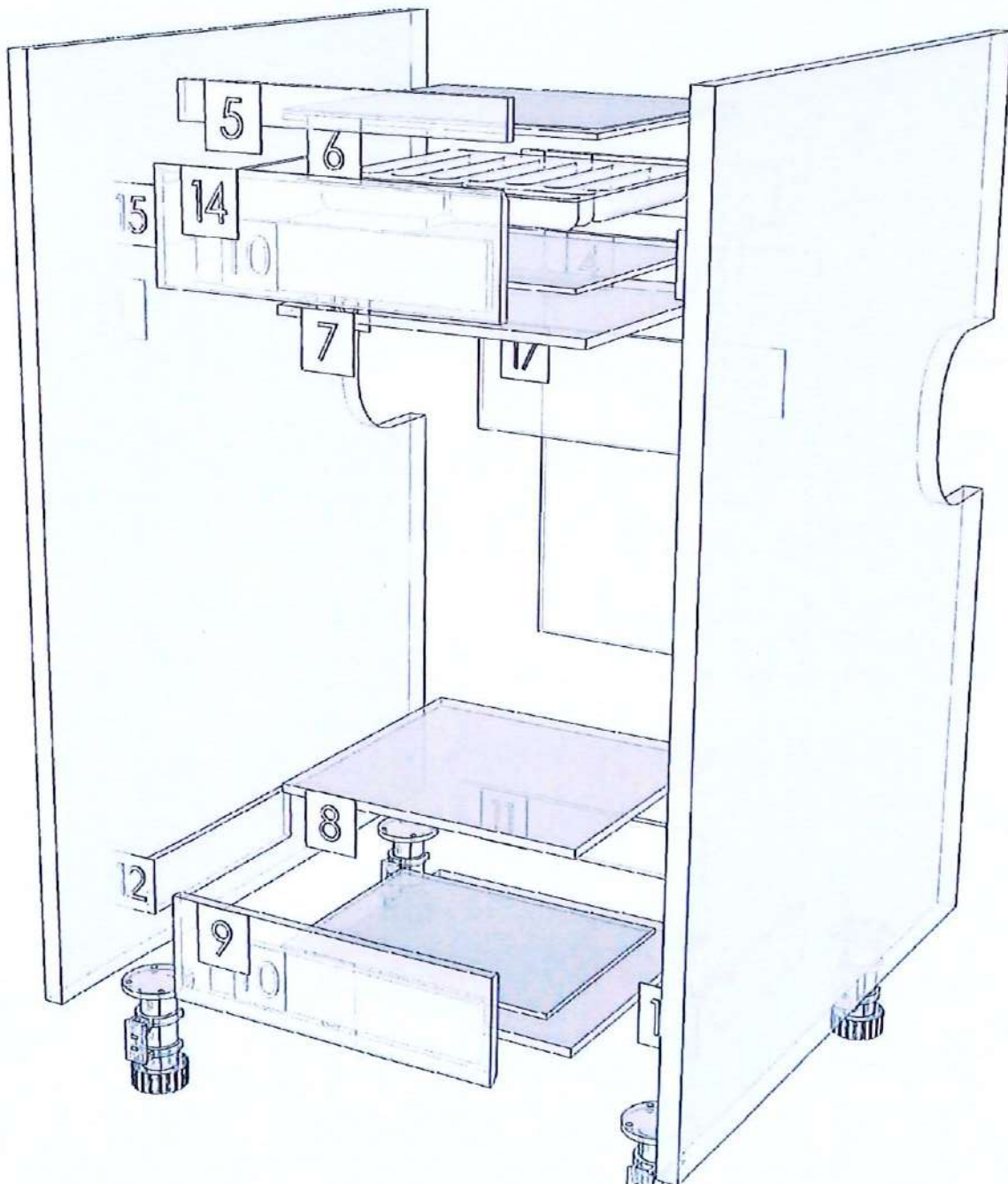

<b>Model</b>	RHYTHM_CN_DBH602(LR)		
<b>Creator</b>	CHALEAMPHON	<b>.BCP Name</b>	INDEX_C3D_KITCHEN2
<b>Reviewer</b>		<b>Order</b>	H001795
<b>Approves</b>	P. SAWA	<b>Date</b>	14/06/2025

No.	Article No.	Description	Mat	Dimension	Cutting Size	Typeology	SkIn
0	RHYTHM_CN_DBH602(LR)			600x785x570			
	RHYTHM_CN_DBH602(LR)-01	LEFT	FB-ST	16x570x785	16X568X783;L2:W2	181000_STR=05 68 _EDG=BT1-1	2
	RHYTHM_CN_DBH602(LR)-02	RIGHT	FB-ST	16x570x785	16X568X783;L2:W2	181001_STR=05 68 _EDG=BT1-1	2
	RHYTHM_CN_DBH602(LR)-03	BOTTOM	FB-ST	16x504x567	16X502X567;L2:W0	182000_STR=05 68 _EDG=BT1-1	2
	RHYTHM_CN_DBH602(LR)-04	BACK SP	FB-ST	16x567x784	16X567X782;L0:W2	186000_STR=05 68 _EDG=BT1-1	2
	RHYTHM_CN_DBH602(LR)-05	BEAM FRONT	FB-ST	16x60x567	16X58X567;L2:W0	183000_STR=05 68 _EDG=BT1-1	2
	RHYTHM_CN_DBH602(LR)-06	HEAT SHIELD	FB-ST	9x477x567	9X475X567;L2:W0	182001_STR=05 68 _EDG=BT1-1	2
	RHYTHM_CN_DBH602(LR)-07	FIX SHELF T.	FB-ST	16x504x567	16X502X567;L2:W0	182002_STR=05 68 _EDG=BT1-1	2
	RHYTHM_CN_DBH602(LR)-08	FIX SHELF B.	FB-ST	16x504x567	16X502X567;L2:W0	182003_STR=05 68 _EDG=BT1-1	2
	RHYTHM_CN_DBH602(LR)-09	FRONT DW. B_SF(W1)	FB-ST	19x597x177	19X595X175;L2:W2	186001_STR=05 68 _EDG=BT1-1	2
	RHYTHM_CN_DBH602(LR)-10	DOUBLE DW. T	FB-ST	16x98x509	16X96X509;L2:W0	183004_STR=20 04 _EDG=SANDSTONE073-1	2
	RHYTHM_CN_DBH602(LR)-10	DOUBLE DW. B	FB-ST	16x98x509	16X96X509;L2:W0	183002_STR=20 04 _EDG=SANDSTONE073-1	2
	RHYTHM_CN_DBH602(LR)-11	REAR DW. B	FB-ST	16x98x509	16X96X509;L2:W0	183003_STR=20 04 _EDG=SANDSTONE073-1	2
	RHYTHM_CN_DBH602(LR)-11	REAR DW. T	FB-ST	16x98x509	16X96X509;L2:W0	183005_STR=20 04 _EDG=SANDSTONE073-1	2
	RHYTHM_CN_DBH602(LR)-12	SIDE DW. B	FB-ST	16x98x400	16X96X400;L2:W0	184000_STR=20 04 _EDG=SANDSTONE073-1	2
	RHYTHM_CN_DBH602(LR)-12	SIDE DW. T	FB-ST	16x98x400	16X96X400;L2:W0	184001_STR=20 04 _EDG=SANDSTONE073-1	2
	RHYTHM_CN_DBH602(LR)-13	BASE DW. B	FB-ST	9x376x519	9X376X519;NO EDGE	182004_STR=20 04 _EDG=-	2
	RHYTHM_CN_DBH602(LR)-14	FRONT DW. T_SF(W1)	FB-ST	19x597x183	19X595X181;L2:W2	186002_STR=05 68 _EDG=BT1-1	2
	RHYTHM_CN_DBH602(LR)-15	SIDE DW. T	FB-ST	16x98x500	16X96X500;L2:W0	184002_STR=20 04 _EDG=SANDSTONE073-1	2
	RHYTHM_CN_DBH602(LR)-15	SIDE DW. T	FB-ST	16x98x500	16X96X500;L2:W0	184003_STR=20 04 _EDG=SANDSTONE073-1	2
	RHYTHM_CN_DBH602(LR)-16	BASE DW. T	FB-ST	9x477x519	9X477X519;NO EDGE	182005_STR=20 04 _EDG=-	2
	RHYTHM_CN_DBH602(LR)-17	FRONT	FB-ST	16x200x567	16X199X567;L1:W0	183001_STR=20 04 _EDG=SANDSTONE073-1	2

Model	RHYTHM_CN_DB130R(S1)		
Creator	CHALEAMPHON	.BCP Name	INDEX_C3D_KITCHEN2
Reviewer		Order	H002063
Approves	P. SAWMI	Date	08/10/2025

## RHYTHM\_CN\_DB130R(S1)-1300X600X885

**Colour**

05.68=ML.BROWN NORDIC#BT1 (MATT WOODGRAIN)

06.01=TEXTURE DEAD STOCK

**Edge**

01.381=1 ML.BROWN NORDIC BT1

<b>R&amp;D REVIEW</b>	
<input checked="" type="checkbox"/>	DWG.Customer
<input checked="" type="checkbox"/>	Work Report
<input type="checkbox"/>	Function
<input type="checkbox"/>	สินค้าตรงตัวอย่าง
ผู้ควบคุม P. SAWMI	
9 / 10 / 2025	

K1005R-160168989



PRODUCT SIZE DRAWING :1300 X D600 X H885

PAGE 1

Model	-		
Creator	CHALEAMPHON	.BCP Name	INDEX_C3D_KITCHEN2
Reviewer		Order	H002063
Approves	P. JAWA I	Date	08/10/2025

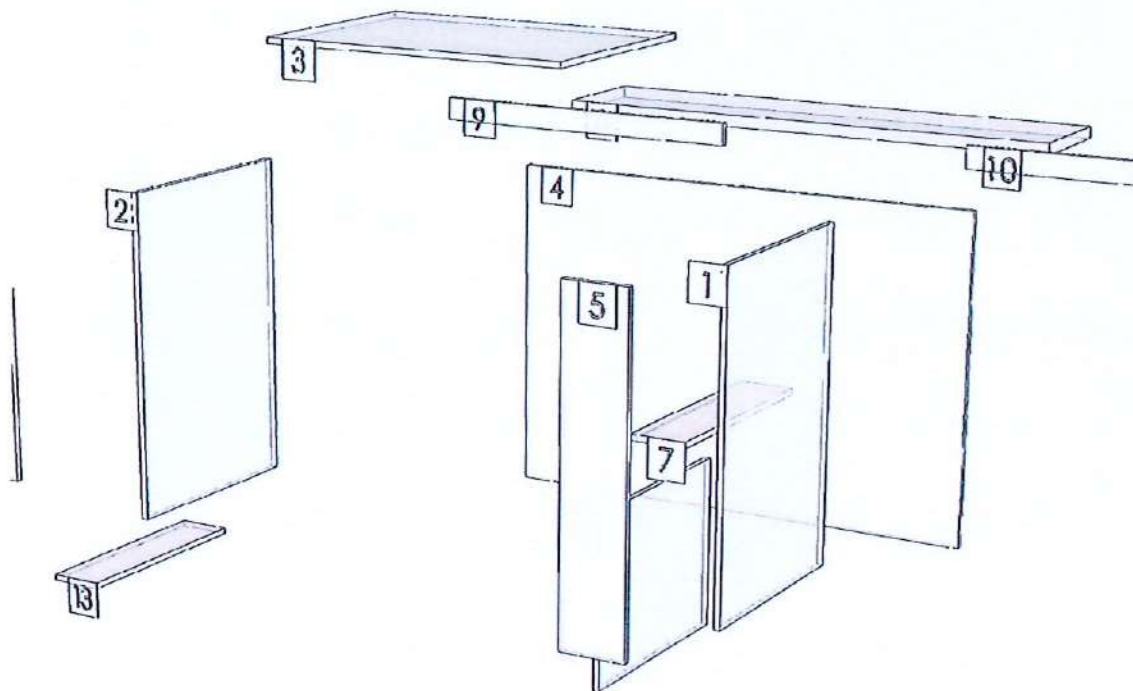

<b>Model</b>	RHYTHM_CN_DB130R(S1)		
<b>Creator</b>	CHALEAMPON	<b>.BCP Name</b>	INDEX_C3D_KITCHEN2
<b>Reviewer</b>		<b>Order</b>	H002063
<b>Approves</b>	<i>P. SAMAI</i>	<b>Date</b>	08/10/2025

No.	Article No.	Description	Mat	Dimension	Cutting Size	Typeology	Skin
0	RHYTHM_CN_DB130R(S1)			1300x885x600			
	RHYTHM_CN_DB130R(S1)-01	RIGHT	PB-ST	16x567x885	16X566X883;L1:W2	181000_STR-05.68_EDG-BTI-1	2
	RHYTHM_CN_DB130R(S1)-02	LEFT	PB-ST	19x584x885	19X582X883;L2:W2	181001_STR-05.68_EDG-BTI-1	2
	RHYTHM_CN_DB130R(S1)-03	CLOSE ON	PB-ST	16x567x860	16X566X860;L1:W0	182000_STR-05.68_EDG-BTI-1	2
	RHYTHM_CN_DB130R(S1)-04	CLOSE FRONT	PB-ST	16x1331x885	16X1331X883;L0:W2	186000_STR-05.68_EDG-BTI-1	2
	RHYTHM_CN_DB130R(S1)-05	FILLER	PB-ST	16x182x885	16X180X883;L2:W2	186001_STR-05.68_EDG-BTI-1	2
	RHYTHM_CN_DB130R(S1)-06	SIDE BOX	PB-ST	16x566x452	16X564X450;L2:W2	181002_STR-05.68_EDG-BTI-1	2
	RHYTHM_CN_DB130R(S1)-07	TOP BOX	PB-ST	16x149x567	16X148X567;L1:W0	185000_STR-05.68_EDG-BTI-1	2
	RHYTHM_CN_DB130R(S1)-08	SHELF	PB-	32x300x1416	32X299X1415;L1:W1	182001_STR-05.68_EDG-BTI-1	2
	RHYTHM_CN_DB130R(S1)-09	BEAM BACK L.	PB-ST	16x861x60	16X861X58;L0:W2	185002_STR-05.68_EDG-BTI-1	2
	RHYTHM_CN_DB130R(S1)-10	BEAM BACK R.	PB-ST	16x454x60	16X454X58;L0:W2	185003_STR-05.68_EDG-BTI-1	2
	RHYTHM_CN_DB130R(S1)-11	WEDGE	MDF-ST	9x12x150	9X12X150;NO EDGE	184000_STR-06.01_EDG--	2
	RHYTHM_CN_DB130R(S1)-12	FILLER FRONT	PB-ST	16x150x785	16X149X783;L1:W2	186004_STR-05.68_EDG-BTI-1	2
	RHYTHM_CN_DB130R(S1)-13	FILLER BOTTOM	PB-ST	16x150x570	16X149X569;L1:W1	185001_STR-05.68_EDG-BTI-1	2

Model	RHYTHM_CN_DFCL_1800H		
Creator	CHALEAMPHON	.BCP Name	INDEX_C3D_KITCHEN2
Reviewer		Order	H001977
Approves	<u>P.SAWAI</u>	Date	08/09/2025

## RHYTHM\_CN\_DFCL\_1800H-1800X16X255

Colour

20.04=ML.SANDSTONE#073\_PEARL

Edge

01.155=1 SANDSTONE (P7-500M1)

<b>R&amp;D REVIEW</b>	
<input checked="" type="checkbox"/>	DWG.Customer
<input checked="" type="checkbox"/>	Work Report
<input type="checkbox"/>	Function
<input type="checkbox"/>	สินค้าตรงตัวอย่าง
ผู้ควบคุม <u>P.SAWAI</u>	
<u>9 / 10 / 2025</u>	

- K1002R-160168888
- K1004L-160168944
- K1004R-160168959
- K1005L-160168974
- K1005R-160168989

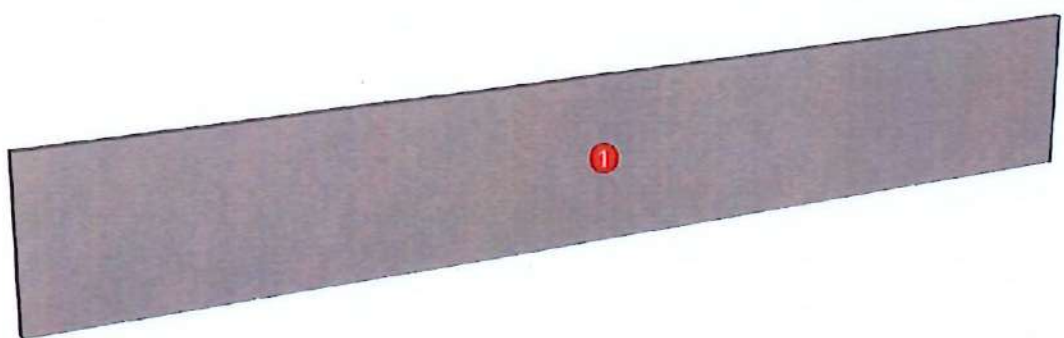

<b>Model</b>	RHYTHM_CN_DFCL_1800H		
<b>Creator</b>	CHALEAMPON	<b>.BCP Name</b>	INDEX_C3D_KITCHEN2
<b>Reviewer</b>		<b>Order</b>	H001977
<b>Approves</b>	<i>P. SAWA</i>	<b>Date</b>	08/09/2025

No.	Article No.	Description	Mat	Dimension	Cutting Size	Typeology	Skin
0	RHYTHM_CN_DFCL_1800H			1800x255x16			
	RHYTHM_CN_DFCL_1800H 02	FILLER TOP	FB ST	16x255x1800	16X254X1798;L1;W2	183000_STR=20.04_EDG=SAN/STONE073-1	2

Model	RHYTHM_CN_DFCL_300H		
Creator	CHALEAMPHON	.BCP Name	INDEX_C3D_KITCHEN2
Reviewer		Order	H001980
Approves	P. SAWA I	Date	08/09/2025

## RHYTHM\_CN\_DFCL\_300H-300X16X255

Colour  
20.04=ML.SANDSTONE#073\_PEARL

Edge  
01.155=1 SANDSTONE (P7-500M1)

R&D REVIEW	
<input checked="" type="checkbox"/>	DWG.Customer
<input checked="" type="checkbox"/>	Work Report
<input type="checkbox"/>	Function
<input type="checkbox"/>	สินค้าตรงตัวอย่าง
ผู้ควบคุม P. SAWA I	
9 / 10 / 2025	

- K1001L-160168916
- K1001R-160168930
- K1002R-160168888
- K1003R-160168901
- K1004L-160168944
- K1004R-160168959
- K1005L-160168974
- K1005R-160168989
- K1006R-160169004

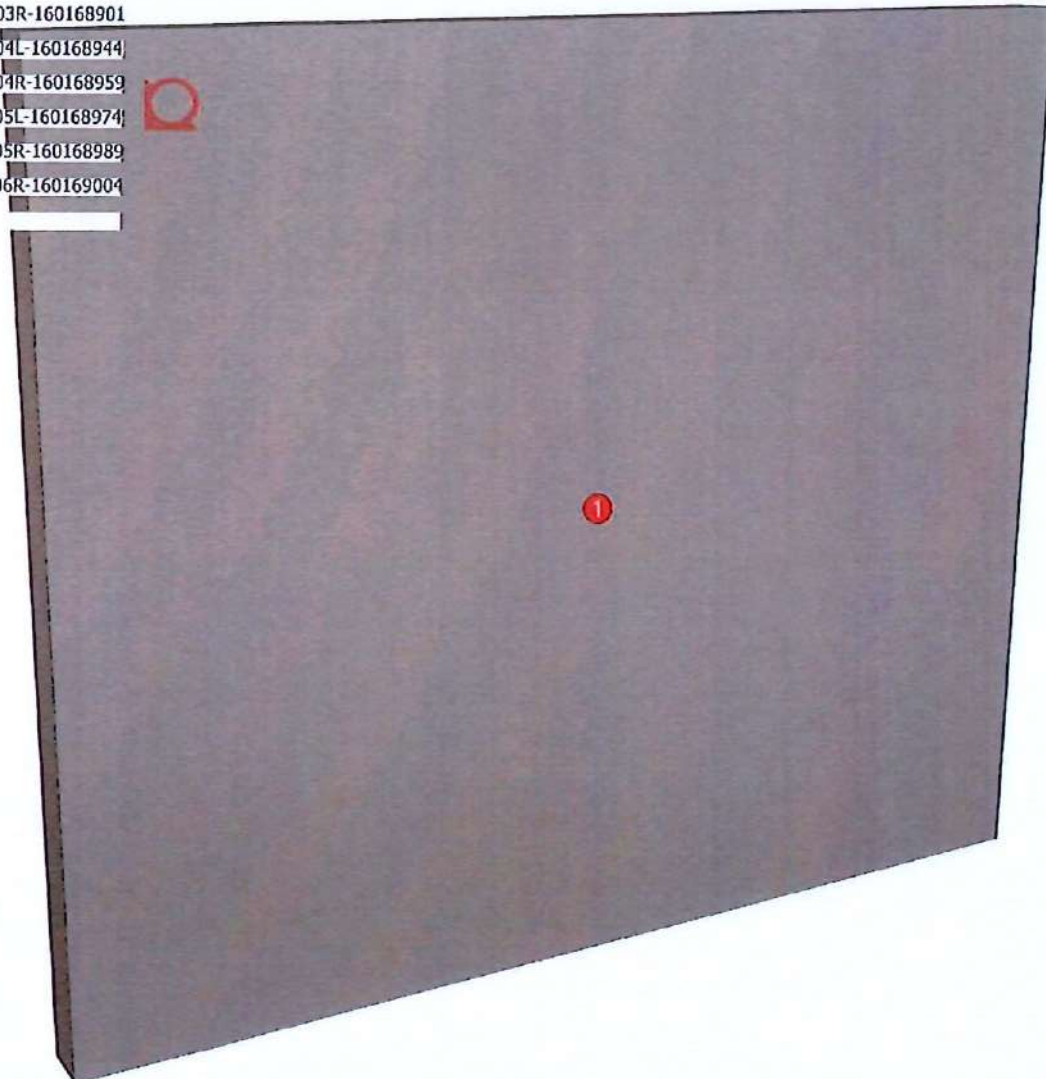

PRODUCT SIZE DRAWING :300 X D16 X H255

PAGE 1

<b>Model</b>	RHYTHM_CN_DFCL_300H		
<b>Creator</b>	CHALEAMPHON	<b>.BCP Name</b>	INDEX_C3D_KITCHEN2
<b>Reviewer</b>		<b>Order</b>	H001980
<b>Approves</b>	P. SAMA	<b>Date</b>	08/09/2025

No.	Article No.	Description	Mat	Dimension	Cutting Size	Typeology	Skin
0	RHYTHM_CN_DFCL_300H RHYTHM_CN_DFCL_300H 01	FILLER TOP	FB-ST	300x255x16 16x255x300	16X254X299;L1:W1	183000_STR=20.04_EDG=5ANDSTONE073-1	2

Model	RHYTHM_CN_DDM_1798		
Creator	CHALEAMPHON	.BCP Name	INDEX_C3D_KITCHEN2
Reviewer		Order	H001973
Approves	P-SAWWI	Date	08/09/2025

## RHYTHM\_CN\_DDM\_1798-1798X6X600

Colour  
03.13=PVC WHITE#630 T0.15MM.

Edge

R&D REVIEW	
<input checked="" type="checkbox"/>	DWG.Customer
<input checked="" type="checkbox"/>	Work Report
<input type="checkbox"/>	Function
<input type="checkbox"/>	สินค้าตรงตัวอย่าง
ผู้ตรวจสอบ P-SAWWI	
9, 10, 2025	

- K1004L-160168944
- K1004R-160168959
- K1005L-160168974
- K1005R-160168989

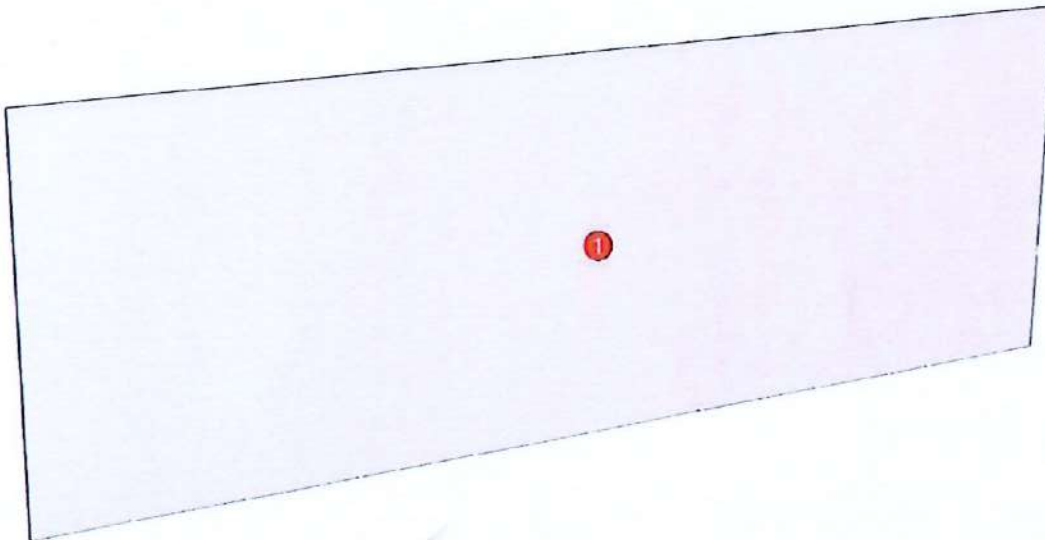

<b>Model</b>	RHYTHM_CN_DDM_1798		
<b>Creator</b>	CHALEAMPHON	<b>.BCP Name</b>	INDEX_C3D_KITCHEN2
<b>Reviewer</b>		<b>Order</b>	H001973
<b>Approves</b>	P. SAWA I	<b>Date</b>	08/09/2025

No.	Article No.	Description	Mat	Dimension	Cutting Size	Typepology	Skin
0	RHYTHM_CN_DDM_1798			1798x600x6			
	RHYTHM_CN_DDM_1798 01	WALL MOUNT	MDF-ST	6x600x1798	6x600x1798;NO EDGE	183000_STR-03.13_EDG-	2

<b>Model</b>	RHYTHM_CN_DL60R(H)		
<b>Creator</b>	CHALEAMPHON	<b>.BCP Name</b>	INDEX_C3D_KITCHEN2
<b>Reviewer</b>		<b>Order</b>	H001988
<b>Approves</b>	P-SAWAI	<b>Date</b>	09/09/2025

## RHYTHM\_CN\_DL60R(H)-600X300X1200

**Colour**

05.68=ML.BROWN NORDIC#BT1 (MATT WOODGRAIN)  
20.04=ML.SANDSTONE#073 \_PEARL

**Edge**

01.381=1 ML.BROWN NORDIC BT1  
01.155=1 SANDSTONE (P7-500M1)

**R&D REVIEW**

DWG.Customer

Work Report

Function

สินค้าตรงตัวอย่าง

ผู้ควบคุม P.SAWAI

9, 10, 2025

K1004L-160168944  
K1004R-160168959  
K1005L-160168974  
K1005R-160168989



PRODUCT SIZE DRAWING :600 X D300 X H1200

PAGE 1

Model	-		
Creator	CHALEAMPHON	.BCP Name	INDEX_C3D_KITCHEN2
Reviewer		Order	H001988
Approves	P. SAWA I	Date	09/09/2025

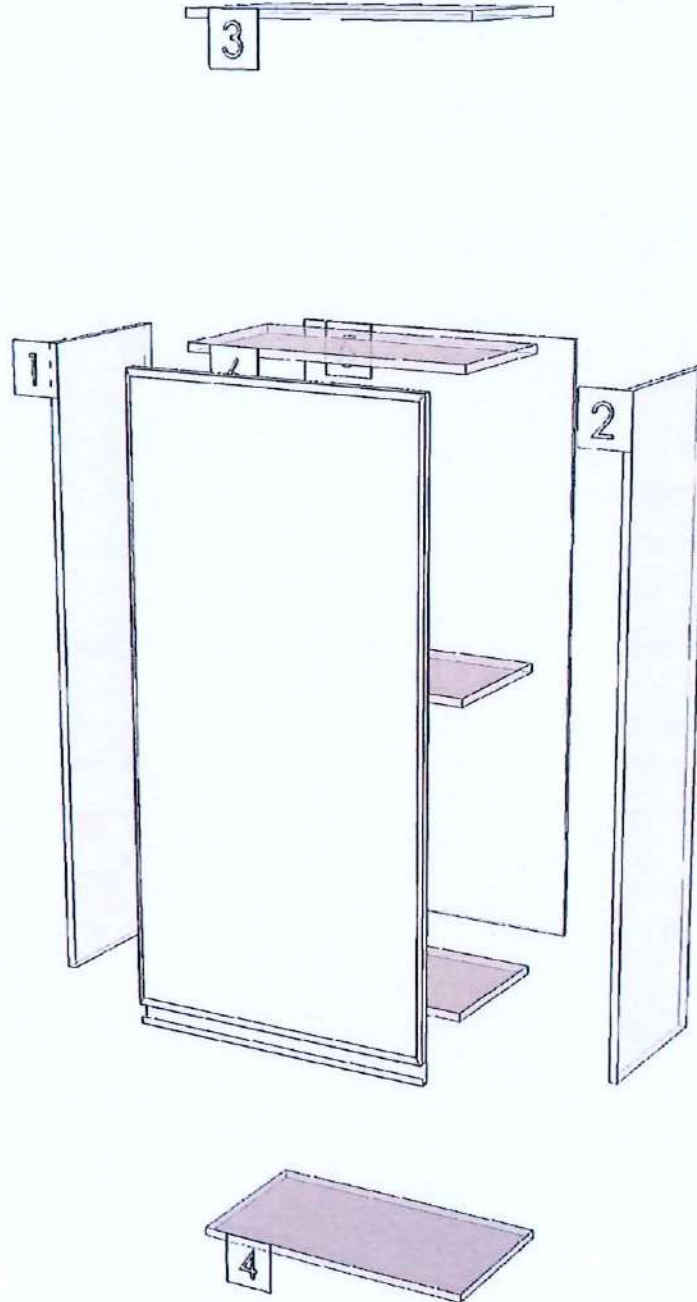

<b>Model</b>	RHYTHM_CN_DL60R(H)		
<b>Creator</b>	CHALEAMPON	<b>.BCP Name</b>	INDEX_C3D_KITCHEN2
<b>Reviewer</b>		<b>Order</b>	H001988
<b>Approves</b>	M. SAWA I	<b>Date</b>	09/09/2025

No.	Article No.	Description	Mat	Dimension	Cutting Size	Typeology	Skin
0	RHYTHM_CN_DL60R(H)			600x1200x300			
	RHYTHM_CN_DL60R(H)-01	LEFT	PB-ST	16x300x1200	16X298X1198;L2:W2	181000_STR=20.04_EDG=SANDSTONE073-1	2
	RHYTHM_CN_DL60R(H)-02	RIGHT	PB-ST	16x300x1200	16X298X1198;L2:W2	181001_STR=20.04_EDG=SANDSTONE073-1	2
	RHYTHM_CN_DL60R(H)-03	TOP	PB-ST	16x300x567	16X298X567;L2:W0	182000_STR=20.04_EDG=SANDSTONE073-1	2
	RHYTHM_CN_DL60R(H)-04	BOTTOM	PB-ST	16x300x567	16X298X567;L2:W0	182001_STR=20.04_EDG=SANDSTONE073-1	2
	RHYTHM_CN_DL60R(H)-05	BACK-SP	PB-ST	9x576x1126	9X576X1126;NO EDGE	186200_STR=20.04_EDG=-	2
	RHYTHM_CN_DL60R(H)-06	SHELF	PB-ST	16x271x566	16X269X564;L2:W2	182002_STR=20.04_EDG=SANDSTONE073-1	2
	RHYTHM_CN_DL60R(H)-06	SHELF	PB-ST	16x271x566	16X269X564;L2:W2	182003_STR=20.04_EDG=SANDSTONE073-1	2
	RHYTHM_CN_DL60R(H)-06	SHELF	PB-ST	16x271x566	16X269X564;L2:W2	182004_STR=20.04_EDG=SANDSTONE073-1	2

<b>Model</b>	RHYTHM_CN_DL60L(H)		
<b>Creator</b>	CHALEAMPHON	<b>.BCP Name</b>	INDEX_C3D_KITCHEN2
<b>Reviewer</b>		<b>Order</b>	H001987
<b>Approves</b>	<u>P. SAWMI</u>	<b>Date</b>	09/09/2025

## RHYTHM\_CN\_DL60L(H)-600X300X1200

**Colour**

05.68=ML.BROWN NORDIC#BT1 (MATT WOODGRAIN)  
20.04=ML.SANDSTONE#073 \_PEARL

**Edge**

01.381=1 ML.BROWN NORDIC BT1  
01.155=1 SANDSTONE (P7-500M1)

<b>R&amp;D REVIEW</b>	
<input checked="" type="checkbox"/>	DWG.Customer
<input checked="" type="checkbox"/>	Work Report
<input type="checkbox"/>	Function
<input type="checkbox"/>	สินค้าตรงตัวอย่าง
ผู้ควบคุม <u>P. SAWMI</u>	
<u>9, 10, 2025</u>	

K1004L-160168944  
K1004R-160168959  
K1005L-160168974  
K1005R-160168989

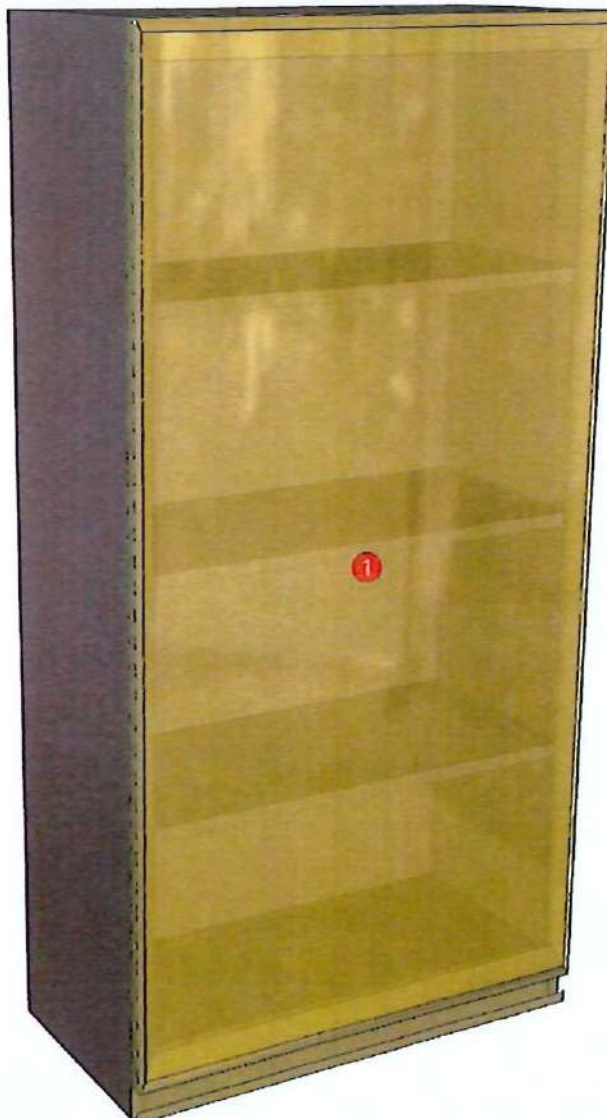

PRODUCT SIZE DRAWING :600 X D300 X H1200

PAGE 1

Model	-		
Creator	CHALEAMPHON	.BCP Name	INDEX_C3D_KITCHEN2
Reviewer		Order	H001987
Approves	<i>P. JAWA 1</i>	Date	09/09/2025

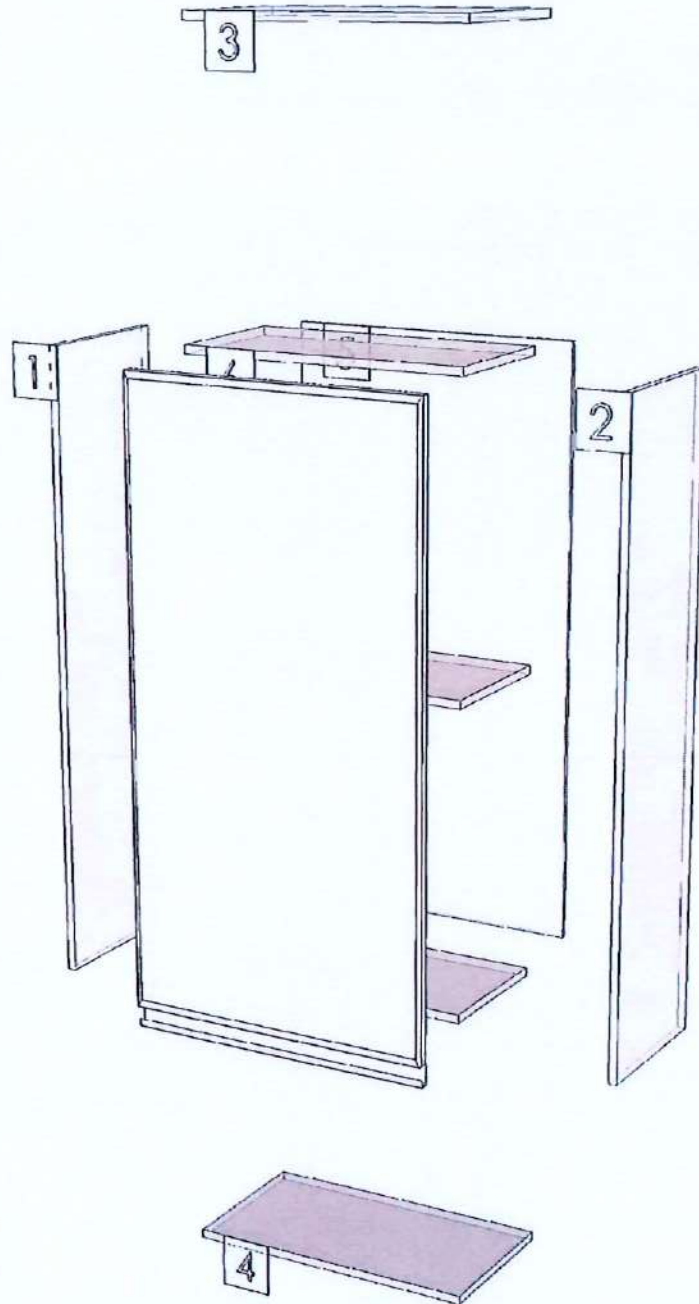

<b>Model</b>	RHYTHM_CN_DL60L(H)		
<b>Creator</b>	CHALEAMPHON	<b>.BCP Name</b>	INDEX_C3D_KITCHEN2
<b>Reviewer</b>		<b>Order</b>	H001987
<b>Approves</b>	P.SAWAN	<b>Date</b>	09/09/2025

No.	Article No.	Description	Mat	Dimension	Cutting Size	Typeology	Skin
0	RHYTHM_CN_DL60L(H)			600x1200x300			
	RHYTHM_CN_DL60L(H) 01	LEFT	PB-ST	16x300x1200	16X298X1198;L2:W2	181000_STR-20.04_EDG=SANDSTONE073-1	2
	RHYTHM_CN_DL60L(H) 02	RIGHT	PB-ST	16x300x1200	16X298X1198;L2:W2	181001_STR-20.04_EDG=SANDSTONE073-1	2
	RHYTHM_CN_DL60L(H) 03	TOP	PB-ST	16x300x567	16X298X567;L2:W0	181000_STR-20.04_EDG=SANDSTONE073-1	2
	RHYTHM_CN_DL60L(H) 04	BOTTOM	PB-ST	16x300x567	16X298X567;L2:W0	182001_STR-20.04_EDG=SANDSTONE073-1	2
	RHYTHM_CN_DL60L(H) 05	BACK_SP	PB-ST	9x576x1126	9X576X1126;NO EDGE	185000_STR-20.04_EDG=-	2
	RHYTHM_CN_DL60L(H) 06	SHELF	PB-ST	16x271x566	16X269X564;L2:W2	182002_STR-20.04_EDG=SANDSTONE073-1	2
	RHYTHM_CN_DL60L(H) 06	SHELF	PB-ST	16x271x566	16X269X564;L2:W2	182003_STR-20.04_EDG=SANDSTONE073-1	2
	RHYTHM_CN_DL60L(H) 06	SHELF	PB-ST	16x271x566	16X269X564;L2:W2	182004_STR-20.04_EDG=SANDSTONE073-1	2

<b>Model</b>	RHYTHM_CN_DL60(H2)R		
<b>Creator</b>	CHALEAMPHON	<b>.BCP Name</b>	INDEX_C3D_KITCHEN2
<b>Reviewer</b>		<b>Order</b>	H001990
<b>Approves</b>	P. SAWAI	<b>Date</b>	10/09/2025

## RHYTHM\_CN\_DL60(H2)R-600X300X1160

**Colour**

05.68=ML.BROWN NORDIC#BT1 (MATT WOODGRAIN)  
20.04=ML.SANDSTONE#073 \_PEARL

**Edge**

01.381=1 ML.BROWN NORDIC BT1  
01.155=1 SANDSTONE (P7-500M1)

**R&D REVIEW**

DWG.Customer

Work Report

Function

สินค้าตรงตัวอย่าง

ผู้ควบคุม P. SAWAI

9 / 10 / 2025

K1001L-160168916  
K1004R-160168959  
K1005R-160168989

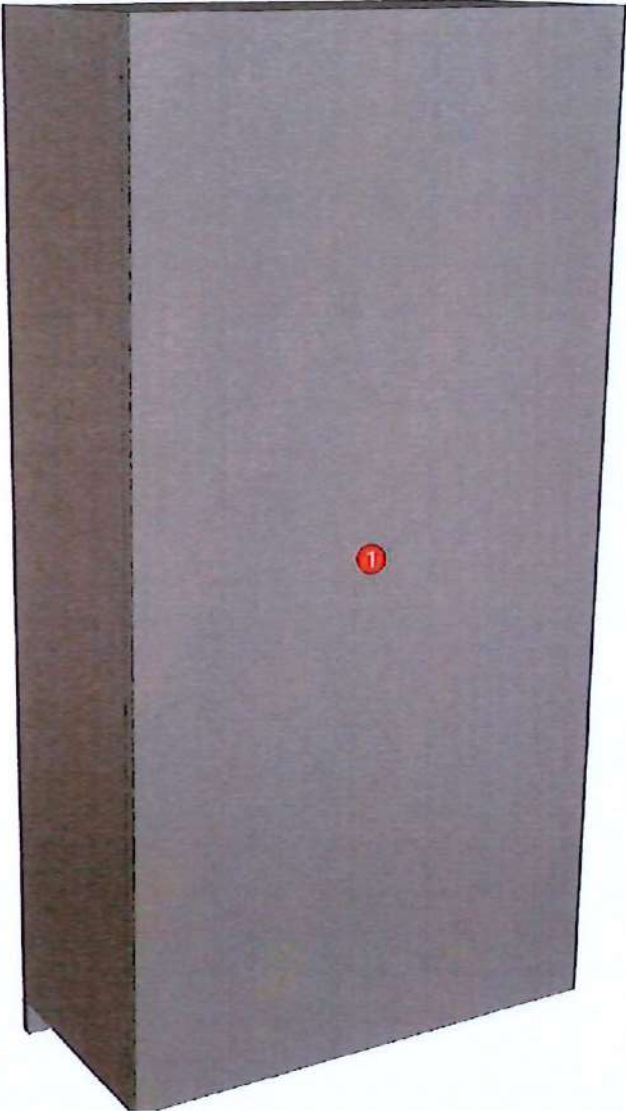

PRODUCT SIZE DRAWING :600 X D300 X H1160

Model	-		
Creator	CHALEAMPHON	.BCP Name	INDEX_C3D_KITCHEN2
Reviewer		Order	H001990
Approves	P.SAWA	Date	10/09/2025

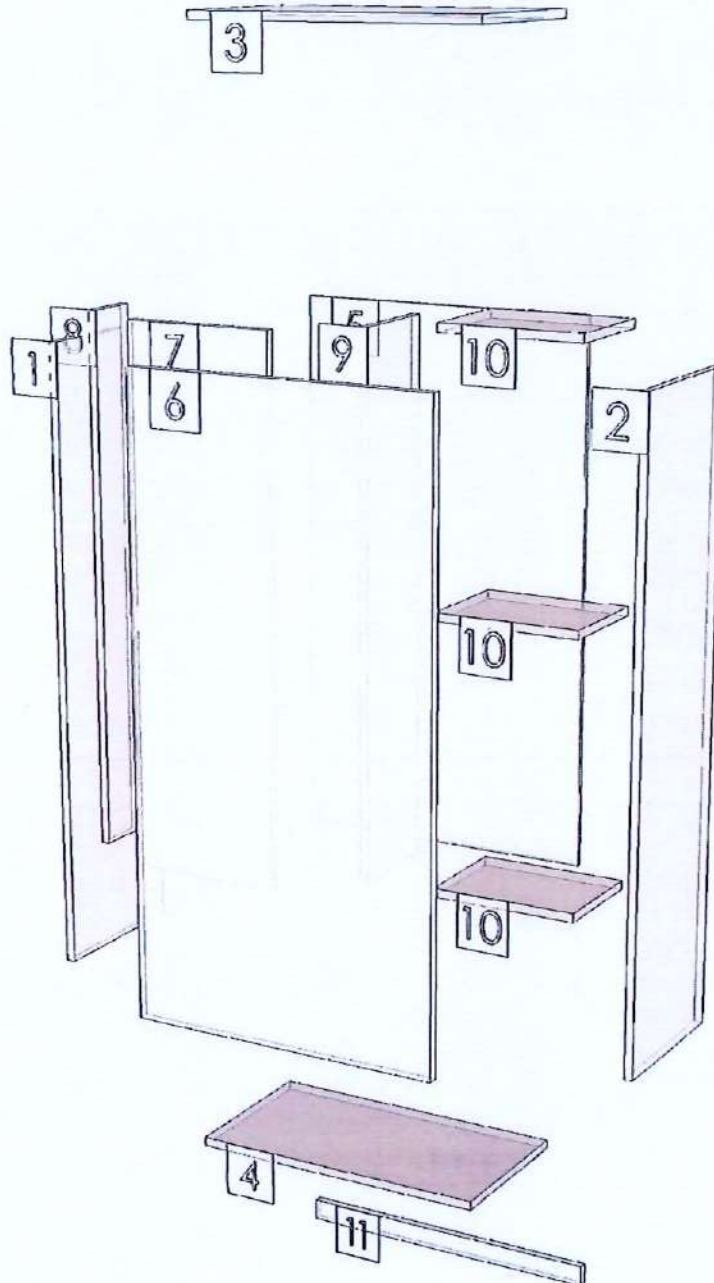

<b>Model</b>	RHYTHM_CN_DL60(H2)R		
<b>Creator</b>	CHALEAMPHON	<b>.BCP Name</b>	INDEX_C3D_KITCHEN2
<b>Reviewer</b>		<b>Order</b>	H001990
<b>Approves</b>	P. SAWAI	<b>Date</b>	10/09/2025

No.	Article No.	Description	Mat	Dimension	Cutting Size	Typepology	Skin
0	RHYTHM_CN_DL60(H2)R			600x1160x300			
	RHYTHM_CN_DL60(H2)R-01	LEFT	PB-ST	16x300x1160	16X298X1158;L2:W2	181000_STR=20.04_EDG-SANDSTONE073-1	2
	RHYTHM_CN_DL60(H2)R-02	RIGHT	PB-ST	16x300x1160	16X298X1158;L2:W2	181001_STR=20.04_EDG-SANDSTONE073-1	2
	RHYTHM_CN_DL60(H2)R-03	TOP	PB-ST	16x300x567	16X298X567;L2:W0	182000_STR=20.04_EDG-SANDSTONE073-1	2
	RHYTHM_CN_DL60(H2)R-04	BOTTOM	PB-ST	16x300x567	16X298X567;L2:W0	182001_STR=20.04_EDG-SANDSTONE073-1	2
	RHYTHM_CN_DL60(H2)R-05	BACK SP	PB-ST	9x576x1004	9X576X1004;NO EDGE	186000_STR=20.04_EDG--	2
	RHYTHM_CN_DL60(H2)R-06	DOOR R.	PB-ST	19x597x1158	19X595X1156;L2:W2	185001_STR=20.04_EDG-SANDSTONE073-1	2
	RHYTHM_CN_DL60(H2)R-07	BOX FRONT	PB-ST	16x290x995	16X288X995;L2:W0	185002_STR=20.04_EDG-SANDSTONE073-1	2
	RHYTHM_CN_DL60(H2)R-08	BOX L	PB-ST	16x100x995	16X100X995;NO EDGE	181002_STR=20.04_EDG--	2
	RHYTHM_CN_DL60(H2)R-09	BOX R	PB-ST	16x184x995	16X184X995;NO EDGE	181003_STR=20.04_EDG--	2
	RHYTHM_CN_DL60(H2)R-10	SHELF	PB-ST	16x198x276	16X196X274;L2:W2	182002_STR=20.04_EDG-SANDSTONE073-1	2
	RHYTHM_CN_DL60(H2)R-10	SHELF	PB-ST	16x198x276	16X196X274;L2:W2	182003_STR=20.04_EDG-SANDSTONE073-1	2
	RHYTHM_CN_DL60(H2)R-10	SHELF	PB-ST	16x198x276	16X196X274;L2:W2	182004_STR=20.04_EDG-SANDSTONE073-1	2
	RHYTHM_CN_DL60(H2)R-11	BACK HOOD	PB-ST	19x40x600	19X38X598;L2:W2	183000_STR=20.04_EDG-SANDSTONE073-1	2

Model	RHYTHM_CN_DUT-500N		
Creator	CHALEAMPHON	.BCP Name	INDEX_C3D_KITCHEN2
Reviewer		Order	H001413
Approves	P. SAWMI	Date	20/12/2024

## RHYTHM\_CN\_DUT-500N-500X60X25



Colour  
20.07=ML.WHITE #VM1012 18/18(MATT)

Edge  
01.47=1 WHITE

R&D REVIEW	
<input checked="" type="checkbox"/>	DWG.Customer
<input checked="" type="checkbox"/>	Work Report
<input type="checkbox"/>	Function
<input type="checkbox"/>	สินค้าตรงตัวอย่าง
ผู้ทบทวน P. SAWMI	
9, 10, 2025	

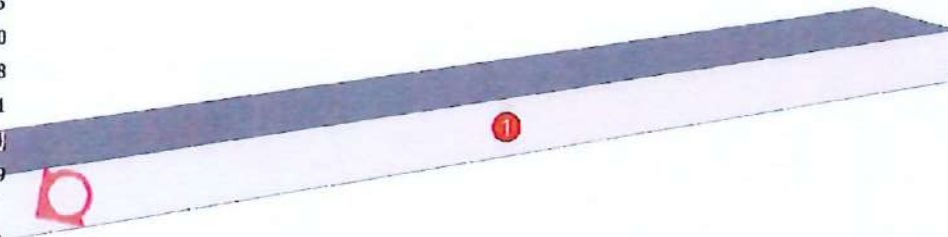
- K101R-160151571
- K102L-160151586
- K102R-160151600
- K103L-160151614
- K104L-160151629
- K106L-160159937
- K207R-160151648
- K208L-160151655
- K100R-160158666
- K103R-160158679
- K105L-160158694
- K107L-160158706
- K104R-160168861
- K108L-160168881
- K1001L-160168916
- K1001R-160168930
- K1002R-160168888
- K1003R-160168901
- K1004L-160168944
- K1004R-160168959
- K106R-160168873
- K1005L-160169874
- K1005R-160168989
- K1006R-160169004



<b>Model</b>	RHYTHM_CN_DUT-500N <span style="color: red; border: 1px solid red; border-radius: 50%; padding: 2px;">7</span>		
<b>Creator</b>	CHALEAMPHON	<b>.BCP Name</b>	INDEX_C3D_KITCHEN2
<b>Reviewer</b>		<b>Order</b>	H001413
<b>Approves</b>		<b>Date</b>	20/12/2024

No.	Article No.	Description	Mat	Dimension	Cutting Size	Typepology	Skin
0	RHYTHM_CN_DUT-500N			500x60x25			
	RHYTHM_CN_DUT-500N 01	UNDER	FB-ST	25x60x500	25X58X500;L2:W0	182000_STR-20.07_EDG-WHITE-1	2

Model	RHYTHM_CN_DUT-1300		
Creator	CHALEAMPHON	.BCP Name	INDEX_C3D_KITCHEN2
Reviewer		Order	H001409
Approves	P-SAWA1	Date	19/12/2024

## RHYTHM\_CN\_DUT-1300-1300X60X25

Colour  
20.07=ML.WHITE #VM1012 18/18(MATT)

Edge  
01.47=1 WHITE

<b>R&amp;D REVIEW</b>	
<input checked="" type="checkbox"/>	DWG.Customer
<input checked="" type="checkbox"/>	Work Report
<input type="checkbox"/>	Function
<input type="checkbox"/>	สินค้าตรงตัวอย่าง
ผู้ทบทวน P-SAWA1	
9 / 10 / 2025	

- K103L-160151614
- K103R-160158679
- K1004L-160168944
- K1004R-160168959
- K1005L-160168974
- K1005R-160168989

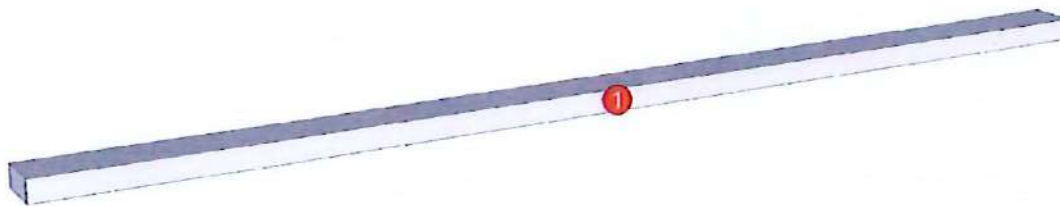

<b>Model</b>	RHYTHM_CN_DUT-1300		
<b>Creator</b>	CHALEAMPHON	<b>.BCP Name</b>	INDEX_C3D_KITCHEN2
<b>Reviewer</b>		<b>Order</b>	H001409
<b>Approves</b>	P. SAWA	<b>Date</b>	19/12/2024

No.	Article No.	Description	Mat	Dimension	Cutting Size	Typepology	Skin
0	RHYTHM_CN_DUT-1300			1300x60x25			
	RHYTHM_CN_DUT-1300-01	UNDER	PB-ST	25x60x1300	25X58X1300;L2:W0	182000_STIR+20.07_EDG=WHITE-1	2

Model	RHYTHM_CN_DUT-1200N		
Creator	CHALEAMPHON	.BCP Name	INDEX_C3D_KITCHEN2
Reviewer		Order	H001408
Approves	P-SAWAI	Date	19/12/2024

## RHYTHM\_CN\_DUT-1200N-1200X60X25

Colour

20.07=ML.WHITE #VM1012 18/18(MATT)

Edge

01.47=1 WHITE

<b>R&amp;D REVIEW</b>	
<input checked="" type="checkbox"/>	DWG.Customer
<input checked="" type="checkbox"/>	Work Report
<input type="checkbox"/>	Function
<input type="checkbox"/>	สินค้าตรงตัวอย่าง
ผู้ควบคุม P-SAWAI	
9 / 10 / 2025	

- K103L-160151614
- K104L-160151629
- K208L-160151655
- K103R-160158679
- K105L-160158694
- K104R-160168861
- K1004L-160168944
- K1004R-160168959
- K1005L-160168974
- K1005R-160168989

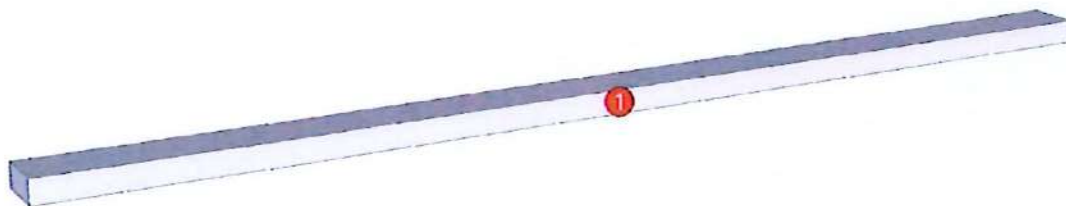

<b>Model</b>	RHYTHM_CN_DUT-1200N		
<b>Creator</b>	CHALEAMPHON	<b>.BCP Name</b>	INDEX_C3D_KITCHEN2
<b>Reviewer</b>		<b>Order</b>	H001408
<b>Approves</b>		<b>Date</b>	19/12/2024

No.	Article No.	Description	Mat	Dimension	Cutting Size	Typepology	Skin
0	RHYTHM_CN_DUT-1200N			1200x25x60			
	RHYTHM_CN_DUT-1200N-01	UNDER	FB-ST	25x60x1200	25X58X1200;L2:W0	182000_STR-20.07_EDG-WHITE-1	2

Model	RHYTHM_CN_DPLT_600N		
Creator	CHALEAMPHON	.BCP Name	INDEX_C3D_KITCHEN2
Reviewer		Order	H001406
Approves	P. SAWMI	Date	19/12/2024

## RHYTHM\_CN\_DPLT\_600N-600X9X100

Colour  
05.68=ML.BROWN NORDIC#BT1 (MATT WOODGRAIN)

Edge  
01.381=1 ML.BROWN NORDIC BT1

**R&D REVIEW**

DWG.Customer

Work Report

Function

สินค้าตรงตัวอย่าง

ผู้ตรวจสอบ P. SAWMI

9, 10, 2025

- K101R-160151571
- K102L-160151586
- K102R-160151600
- K103L-160151614
- K104L-160151629
- K208L-160151655
- K100R-160158666
- K103R-160158679
- K105L-160158694
- K104R-160168861
- K1001L-160168916
- K1001R-160168930
- K1002R-160168888
- K1003R-160168901
- K1004L-160168944
- K1004R-160168959
- K1005L-160168974
- K1005R-160168989
- K1006R-160169004



<b>Model</b>	RHYTHM_CN_DPLT_600N		
<b>Creator</b>	CHALEAMPHON	<b>.BCP Name</b>	INDEX_C3D_KITCHEN2
<b>Reviewer</b>		<b>Order</b>	H001406
<b>Approves</b>		<b>Date</b>	19/12/2024

No.	Article No.	Description	Mat	Dimension	Cutting Size	Typepology	Skin
0	RHYTHM_CN_DPLT_600N			600x100x9			
	RHYTHM_CN_DPLT_600N-01	LED BOTTOM	PB-SP	9x100x600	9X98X599;L2:W1	183000_S1R=05.68_EOG-BT1-1	2

Model	RHYTHM_CN_DPLT_1200G1		
Creator	CHALEAMPHON	.BCP Name	INDEX_C3D_KITCHEN2
Reviewer		Order	H001399
Approves	P.SAWMI	Date	19/12/2024

## RHYTHM\_CN\_DPLT\_1200G1-1200X9X100

Colour

05.68=ML.BROWN NORDIC#BT1 (MATT WOODGRAIN)

Edge

01.381=1 ML.BROWN NORDIC BT1

<b>R&amp;D REVIEW</b>	
<input checked="" type="checkbox"/>	DWG.Customer
<input checked="" type="checkbox"/>	Work Report
<input type="checkbox"/>	Function
<input type="checkbox"/>	สินค้าตรงตัวอย่าง
ผู้ทบทวน <u>P.SAWMI</u>	
<u>9 / 10 / 2025</u>	

K103L-160151614  
K103R-160158679  
K1004L-160168944  
K1004R-160168959  
K1005L-160168974  
K1005R-160168989



<b>Model</b>	RHYTHM_CN_DPLT_1200G1		
<b>Creator</b>	CHALEAMPON	<b>.BCP Name</b>	INDEX_C3D_KITCHEN2
<b>Reviewer</b>		<b>Order</b>	H001399
<b>Approves</b>	P-SAWA	<b>Date</b>	19/12/2024

No.	Article No.	Description	Mat	Dimension	Cutting Size	Typepology	Skin
0	RHYTHM_CN_DPLT_1200G1			1200x100x9			
	RHYTHM_CN_DPLT_1200G1-01	LED BOTTOM	PB-SP	9x100x1200	9X98X1198;L2:W2	183000_STR=05.68_EDG=8T1-1	2