

|                 |                 |                  |                    |
|-----------------|-----------------|------------------|--------------------|
| <b>Model</b>    | LIFE_CN_DBO667R |                  |                    |
| <b>Creator</b>  | PASATHORN       | <b>.BCP Name</b> | INDEX_C3D_KITCHEN2 |
| <b>Reviewer</b> |                 | <b>Order</b>     | I004272            |
| <b>Approves</b> |                 | <b>Date</b>      | 01/07/2025         |

## **LIFE\_CN\_DBO667R-667X570X913**

**Colour**

05.38 ML MD692 (SS)\_  
05.30 ML WHITE SAND #VM1012/2610/2610(PEARL)\_

**Edge**

01.286 1 MD692 \_  
01.47 1 WHITE \_

|                                     |                   |
|-------------------------------------|-------------------|
| <b>R&amp;D REVIEW</b>               |                   |
| <input checked="" type="checkbox"/> | DWG.Customer      |
| <input checked="" type="checkbox"/> | Work Report       |
| <input type="checkbox"/>            | Function          |
| <input type="checkbox"/>            | สินค้าตรงตัวอย่าง |
| ผู้ทบทวน _____                      |                   |

K102L-160166010

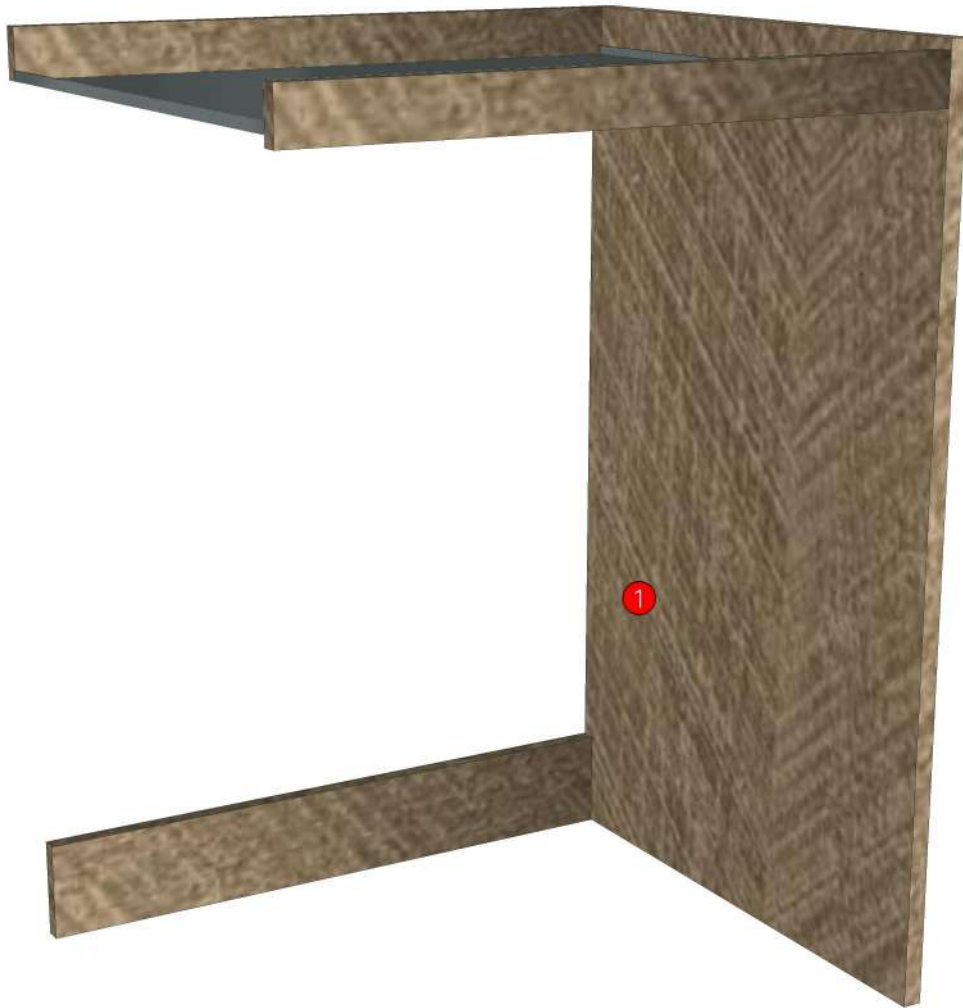

|                 |                  |                  |                    |
|-----------------|------------------|------------------|--------------------|
| <b>Model</b>    | -LIFE_CN_DBO667R |                  |                    |
| <b>Creator</b>  |                  | <b>.BCP Name</b> | INDEX_C3D_KITCHEN2 |
| <b>Reviewer</b> |                  | <b>Order</b>     | I004272            |
| <b>Approves</b> |                  | <b>Date</b>      |                    |

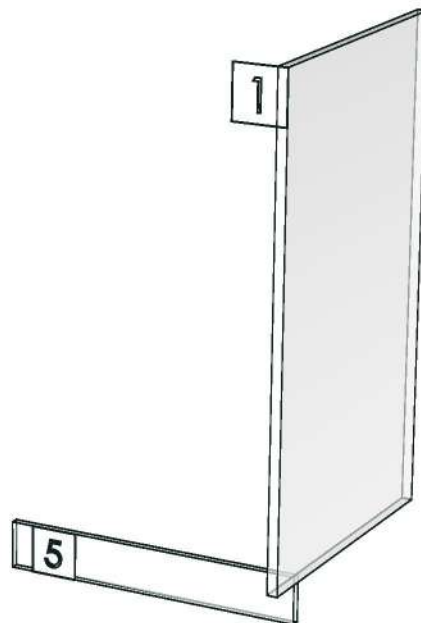
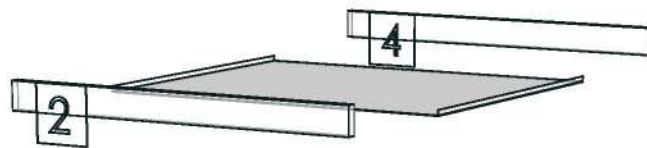

|                 |                   |                  |                    |
|-----------------|-------------------|------------------|--------------------|
| <b>Model</b>    | LIFE_CN_DBS681LGR |                  |                    |
| <b>Creator</b>  | PASATHORN         | <b>.BCP Name</b> | INDEX_C3D_KITCHEN2 |
| <b>Reviewer</b> |                   | <b>Order</b>     | I004298            |
| <b>Approves</b> | P.SAWAI           | <b>Date</b>      | 17/07/2025         |

## **LIFE\_CN\_DBS681LGR-681X570X913**

### **Colour**

05.38 ML MD692 (SS)\_

05.30 ML WHITE SAND #VM1012/2610/2610(PEARL)\_

-

-

-

### **Edge**

01.286 1 MD692 \_

01.457 0.6 MD692 \_

-

-

-

|                                     |                   |
|-------------------------------------|-------------------|
| <b>R&amp;D REVIEW</b>               |                   |
| <input checked="" type="checkbox"/> | DWG.Customer      |
| <input checked="" type="checkbox"/> | Work Report       |
| <input type="checkbox"/>            | Function          |
| <input type="checkbox"/>            | สินค้าตรงตัวอย่าง |
| ผู้ทบทวน P.SAWAI                    |                   |
| 08 / 08 / 68                        |                   |

K102L-160166010



|                 |                    |                  |                    |
|-----------------|--------------------|------------------|--------------------|
| <b>Model</b>    | -LIFE_CN_DBS681LGR |                  |                    |
| <b>Creator</b>  |                    | <b>.BCP Name</b> | INDEX_C3D_KITCHEN2 |
| <b>Reviewer</b> |                    | <b>Order</b>     | I004298            |
| <b>Approves</b> | P.SAWAI            | <b>Date</b>      |                    |

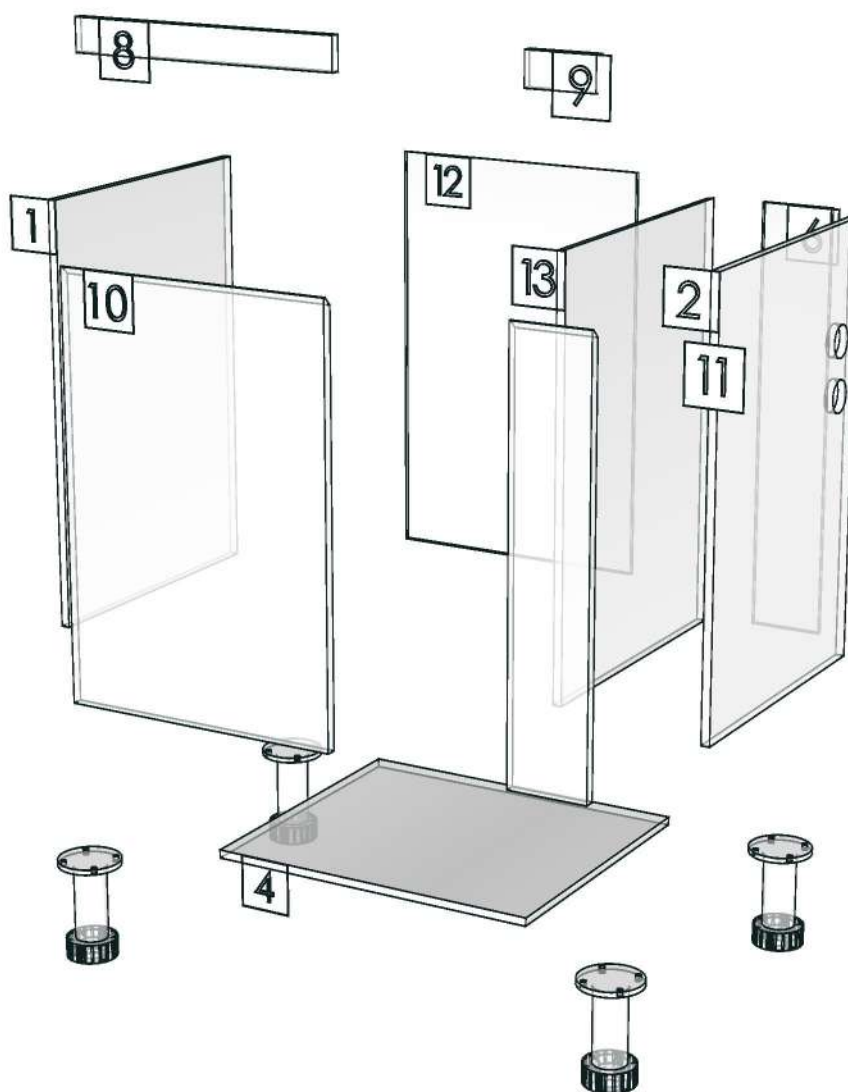

|                 |                |                  |                    |
|-----------------|----------------|------------------|--------------------|
| <b>Model</b>    | LIFE_CN_DDM600 |                  |                    |
| <b>Creator</b>  | PASATHORN      | <b>.BCP Name</b> | INDEX_C3D_KITCHEN2 |
| <b>Reviewer</b> |                | <b>Order</b>     | I003906            |
| <b>Approves</b> | P.SAWAI        | <b>Date</b>      | 31/01/2025         |

## LIFE\_CN\_DDM600-600X16X150

### Colour

05.38 ML MD692 (SS)\_

-

-

-

K100L-160165993

K100R-160157181

K102L-160166010

K102R-160166018

K105L-160136079

### Edge

01.286 1 MD692 \_

-

-

-

-

|                                     |                   |
|-------------------------------------|-------------------|
| <b>R&amp;D REVIEW</b>               |                   |
| <input checked="" type="checkbox"/> | DWG.Customer      |
| <input checked="" type="checkbox"/> | Work Report       |
| <input type="checkbox"/>            | Function          |
| <input type="checkbox"/>            | สินค้าตรงตัวอย่าง |
| ผู้ทบทวน <u>P.SAWAI</u>             |                   |
| <u>31/01/25</u>                     |                   |

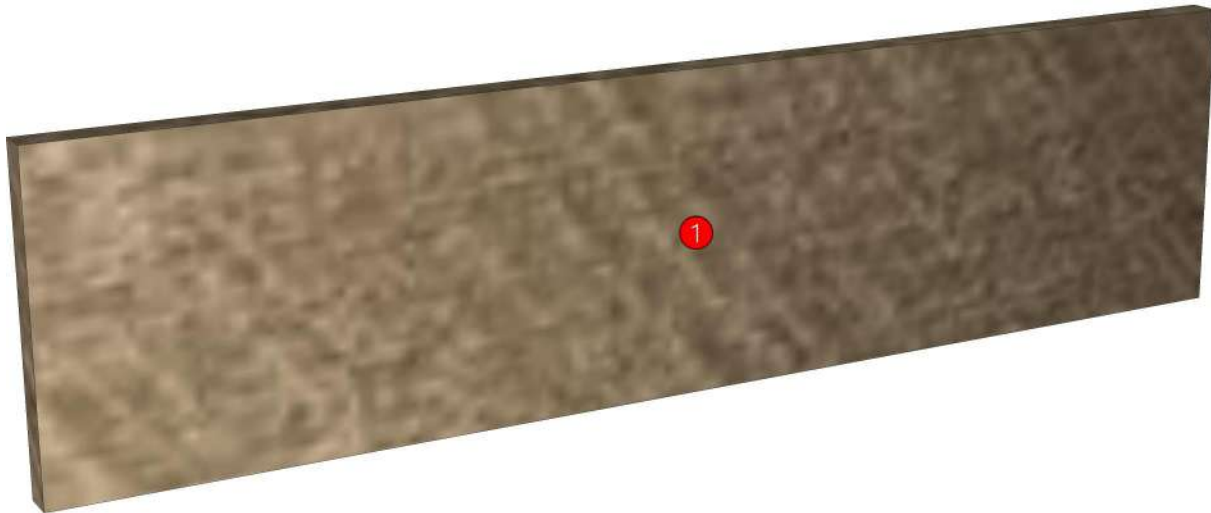

|                 |                |                  |                    |
|-----------------|----------------|------------------|--------------------|
| <b>Model</b>    | LIFE_CN_DDM600 |                  |                    |
| <b>Creator</b>  | PASATHORN      | <b>.BCP Name</b> | INDEX_C3D_KITCHEN2 |
| <b>Reviewer</b> |                | <b>Order</b>     | I003906            |
| <b>Approves</b> | P.SAWAI        | <b>Date</b>      | 31/01/2025         |

| No. | Article No.       | Description    | Mat   | Dimension  | Cutting Size     | Typepology                   | Skin |
|-----|-------------------|----------------|-------|------------|------------------|------------------------------|------|
| 0   | LIFE_CN_DDM600    | LIFE_CN_DDM600 |       | 600x150x16 |                  |                              |      |
|     | LIFE_CN_DDM600-01 | DDM-SP         | PB-SP | 16x150x600 | 16X148X598;L2:W2 | 183000_STR=05.38_EDG=MD692-1 | 2    |

|                 |             |                  |                    |
|-----------------|-------------|------------------|--------------------|
| <b>Model</b>    | LIFE_CN_DFB |                  |                    |
| <b>Creator</b>  | PASATHORN   | <b>.BCP Name</b> | INDEX_C3D_KITCHEN2 |
| <b>Reviewer</b> |             | <b>Order</b>     | I004279            |
| <b>Approves</b> | P.SAWAI     | <b>Date</b>      | 03/07/2025         |

## LIFE\_CN\_DFB-150X16X813

**Colour**

05.38 ML MD692 (SS)\_

-  
-  
-  
-

**Edge**

01.286 1 MD692 \_

-  
-  
-  
-

**R&D REVIEW**

- DWG.Customer
- Work Report
- Function
- สินค้าตรงตัวอย่าง

ผู้ทบทวน P.SAWAI  
03/07/25

K102L-160166010

K102R-160166018



|                 |              |                  |                    |
|-----------------|--------------|------------------|--------------------|
| <b>Model</b>    | -LIFE_CN_DFB |                  |                    |
| <b>Creator</b>  |              | <b>.BCP Name</b> | INDEX_C3D_KITCHEN2 |
| <b>Reviewer</b> |              | <b>Order</b>     | I004279            |
| <b>Approves</b> | P.SAWAI      | <b>Date</b>      |                    |

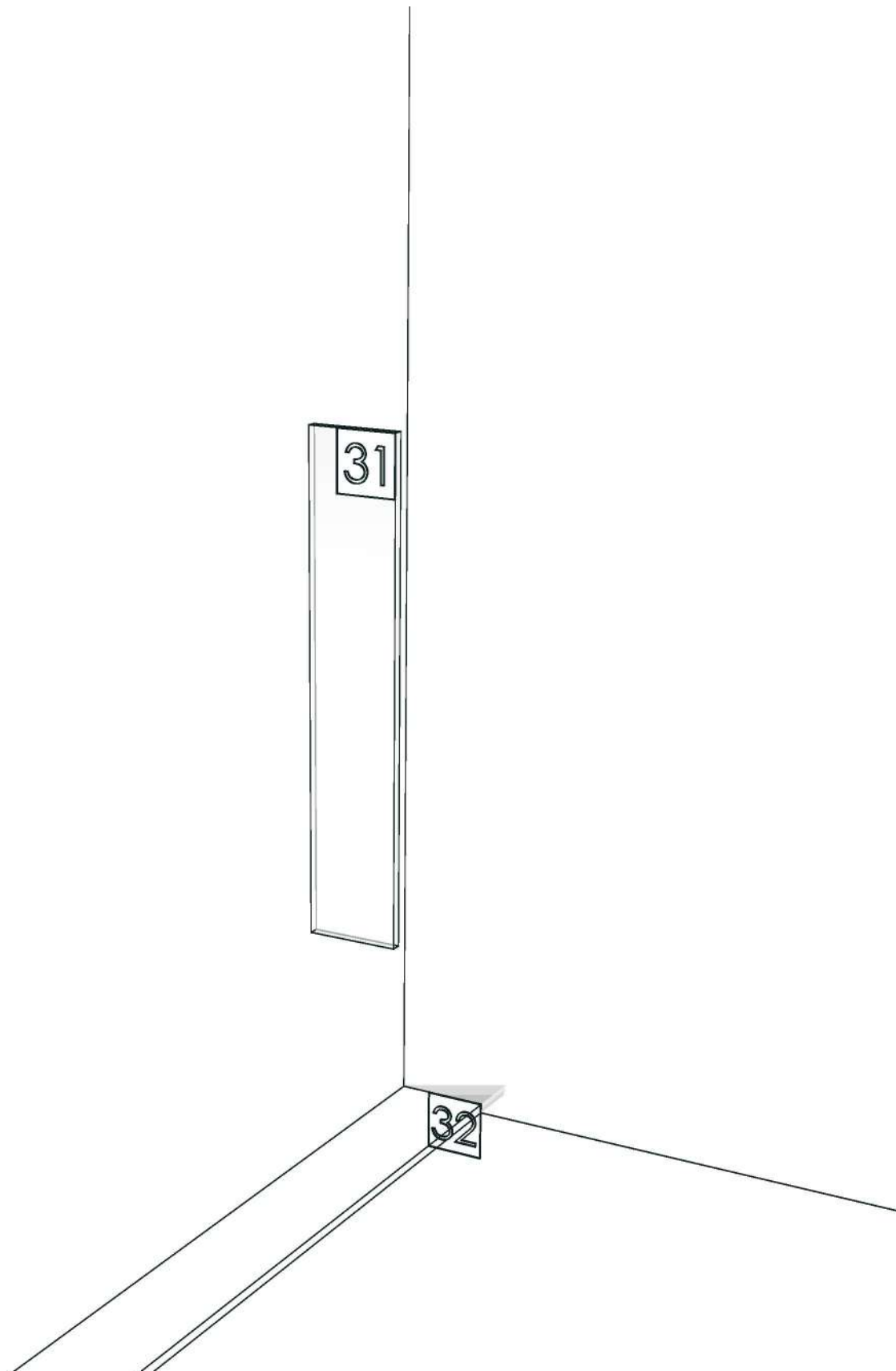



|                 |               |                  |                    |
|-----------------|---------------|------------------|--------------------|
| <b>Model</b>    | LIFE_CN_DFLMV |                  |                    |
| <b>Creator</b>  | PASATHORN     | <b>.BCP Name</b> | INDEX_C3D_KITCHEN2 |
| <b>Reviewer</b> |               | <b>Order</b>     | I004258            |
| <b>Approves</b> | P.SAWAI       | <b>Date</b>      | 30/06/2025         |

## LIFE\_CN\_DFLMV-150X16X1050

**Colour**

05.38 ML MD692 (SS)\_

-  
-  
-  
-

**Edge**

01.286 1 MD692 \_

-  
-  
-  
-

|                                     |                   |
|-------------------------------------|-------------------|
| <b>R&amp;D REVIEW</b>               |                   |
| <input checked="" type="checkbox"/> | DWG.Customer      |
| <input checked="" type="checkbox"/> | Work Report       |
| <input type="checkbox"/>            | Function          |
| <input type="checkbox"/>            | สินค้าตรงตัวอย่าง |
| ผู้ทบทวน <u>P.SAWAI</u>             |                   |
| <u>30/6/25</u>                      |                   |

K102L-160166010

K102R-160166018

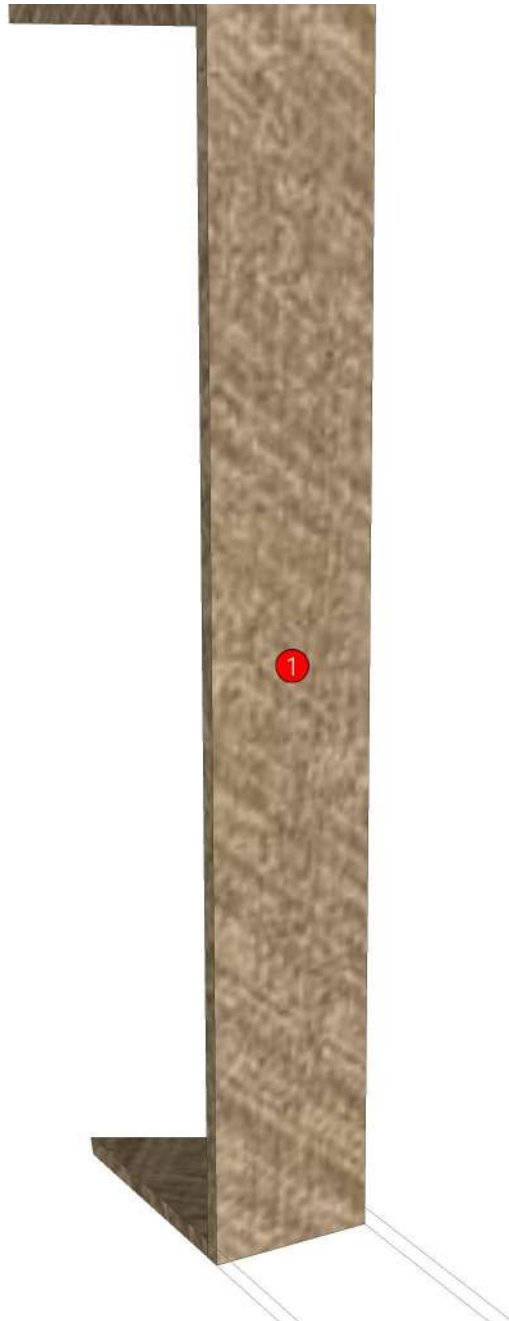

|                 |                |                  |                    |
|-----------------|----------------|------------------|--------------------|
| <b>Model</b>    | -LIFE_CN_DFLMV |                  |                    |
| <b>Creator</b>  |                | <b>.BCP Name</b> | INDEX_C3D_KITCHEN2 |
| <b>Reviewer</b> |                | <b>Order</b>     | I004258            |
| <b>Approves</b> | P.SAWAI        | <b>Date</b>      |                    |

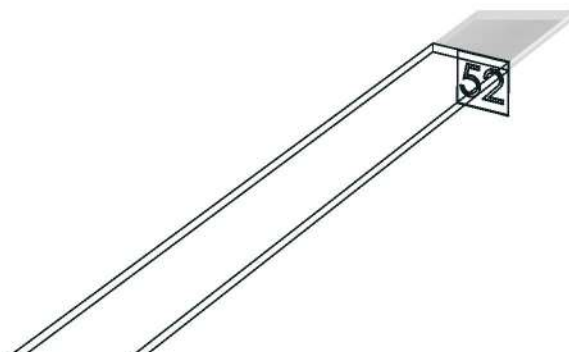

|                 |                   |                  |                    |
|-----------------|-------------------|------------------|--------------------|
| <b>Model</b>    | LIFE_CN_DF_CL1450 |                  |                    |
| <b>Creator</b>  | PASATHORN         | <b>.BCP Name</b> | INDEX_C3D_KITCHEN2 |
| <b>Reviewer</b> |                   | <b>Order</b>     | I004255            |
| <b>Approves</b> |                   | <b>Date</b>      | 30/06/2025         |

## **LIFE\_CN\_DF\_CL1450-1450X16X155**

**Colour**

05.38 ML MD692 (SS)\_

-

-

-

-

**Edge**

01.286 1 MD692 \_

-

-

-

-

K102L

K102R

|                                     |                   |
|-------------------------------------|-------------------|
| <b>R&amp;D REVIEW</b>               |                   |
| <input checked="" type="checkbox"/> | DWG.Customer      |
| <input checked="" type="checkbox"/> | Work Report       |
| <input type="checkbox"/>            | Function          |
| <input type="checkbox"/>            | สินค้าตรงตัวอย่าง |
| ผู้ทบทวน _____                      |                   |
| _____                               |                   |

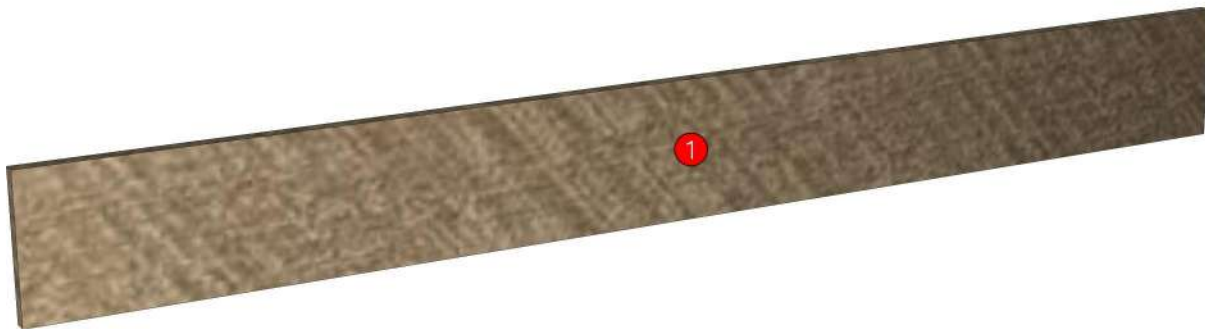

|                 |                   |                  |                    |
|-----------------|-------------------|------------------|--------------------|
| <b>Model</b>    | LIFE_CN_DF_CL1450 |                  |                    |
| <b>Creator</b>  | PASATHORN         | <b>.BCP Name</b> | INDEX_C3D_KITCHEN2 |
| <b>Reviewer</b> |                   | <b>Order</b>     | I004255            |
| <b>Approves</b> |                   | <b>Date</b>      | 30/06/2025         |

| No. | Article No.          | Description       | Mat   | Dimension   | Cutting Size      | Typepology                   | Skin |
|-----|----------------------|-------------------|-------|-------------|-------------------|------------------------------|------|
| 0   | LIFE_CN_DF_CL1450    | LIFE_CN_DF_CL1450 |       | 1450x155x16 |                   |                              |      |
|     | LIFE_CN_DF_CL1450-01 | DF_CL-SP          | PB-SP | 16x155x1450 | 16X154X1449;L1:W1 | 183000_STR=05.38_EDG=MD692-1 | 2    |

|                 |                  |                  |                    |
|-----------------|------------------|------------------|--------------------|
| <b>Model</b>    | LIFE_CN_DF_CL350 |                  |                    |
| <b>Creator</b>  | PASATHORN        | <b>.BCP Name</b> | INDEX_C3D_KITCHEN2 |
| <b>Reviewer</b> |                  | <b>Order</b>     | I003898            |
| <b>Approves</b> | P.SAWAI          | <b>Date</b>      | 31/01/2025         |

## LIFE\_CN\_DF\_CL350-350X16X155

### Colour

05.38 ML MD692 (SS)\_

-

-

-

K100L-160165993

K100R-160157181

K102L-160166010

K102R-160166018

K103L-160157198

K104L-160136071

K105L-160136079

### Edge

01.286 1 MD692 \_

-

-

-

-

|                                     |                   |
|-------------------------------------|-------------------|
| <b>R&amp;D REVIEW</b>               |                   |
| <input checked="" type="checkbox"/> | DWG.Customer      |
| <input checked="" type="checkbox"/> | Work Report       |
| <input type="checkbox"/>            | Function          |
| <input type="checkbox"/>            | สินค้าตรงตัวอย่าง |
| ผู้ทบทวน <u>P.SAWAI</u>             |                   |
| <u>31/01/25</u>                     |                   |

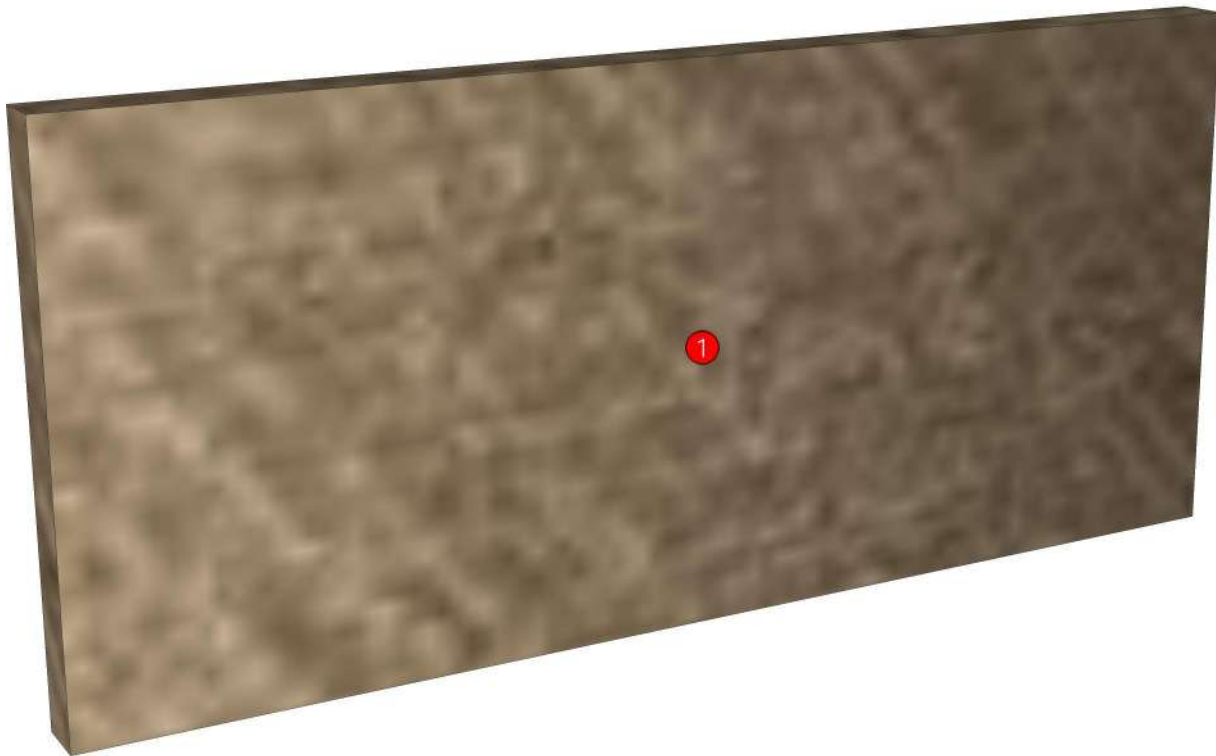

|                 |                  |                  |                    |
|-----------------|------------------|------------------|--------------------|
| <b>Model</b>    | LIFE_CN_DF_CL350 |                  |                    |
| <b>Creator</b>  | PASATHORN        | <b>.BCP Name</b> | INDEX_C3D_KITCHEN2 |
| <b>Reviewer</b> |                  | <b>Order</b>     | I003898            |
| <b>Approves</b> | P.SAWAI          | <b>Date</b>      | 31/01/2025         |

| No. | Article No.         | Description      | Mat   | Dimension  | Cutting Size     | Typepology                   | Skin |
|-----|---------------------|------------------|-------|------------|------------------|------------------------------|------|
| 0   | LIFE_CN_DF_CL350    | LIFE_CN_DF_CL350 |       | 350x155x16 |                  |                              |      |
|     | LIFE_CN_DF_CL350-01 | DF_CL-SP         | PB-SP | 16x155x350 | 16X154X349;L1:W1 | 183000_STR=05.38_EDG=MD692-1 | 2    |

|                 |                 |                  |                    |
|-----------------|-----------------|------------------|--------------------|
| <b>Model</b>    | LIFE_CN_DL60HRS |                  |                    |
| <b>Creator</b>  | PASATHORN       | <b>.BCP Name</b> | INDEX_C3D_KITCHEN2 |
| <b>Reviewer</b> |                 | <b>Order</b>     | I004264            |
| <b>Approves</b> | P.SAWAI         | <b>Date</b>      | 01/07/2025         |

## **LIFE\_CN\_DL60HRS-600X350X860**

**Colour**

05.38 ML MD692 (SS)\_  
05.30 ML WHITE SAND #VM1012/2610/2610(PEARL)\_  
-  
-  
K100L-160165993

**Edge**

01.286 1 MD692 \_  
01.47 1 WHITE \_  
-  
-

**R&D REVIEW**

- DWG.Customer
- Work Report
- Function
- สินค้าตรงตัวอย่าง

ผู้ทบทวน P.SAWAI  
01/07/25

K102L-160166010

K105L-160136079



|                 |                  |                  |                    |
|-----------------|------------------|------------------|--------------------|
| <b>Model</b>    | -LIFE_CN_DL60HRS |                  |                    |
| <b>Creator</b>  |                  | <b>.BCP Name</b> | INDEX_C3D_KITCHEN2 |
| <b>Reviewer</b> |                  | <b>Order</b>     | I004264            |
| <b>Approves</b> | P.SAWAI          | <b>Date</b>      |                    |

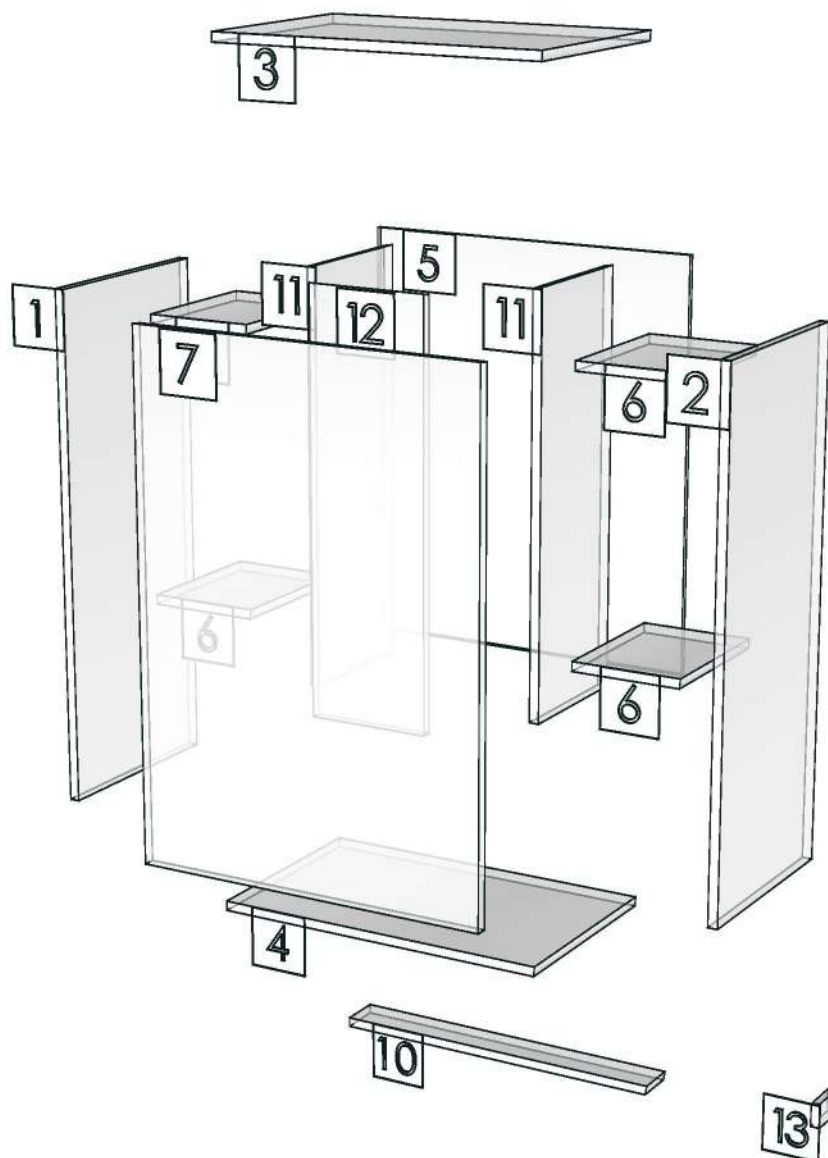



|                 |                |                  |                    |
|-----------------|----------------|------------------|--------------------|
| <b>Model</b>    | LIFE_CN_DLMV75 |                  |                    |
| <b>Creator</b>  | PASATHORN      | <b>.BCP Name</b> | INDEX_C3D_KITCHEN2 |
| <b>Reviewer</b> |                | <b>Order</b>     | I004276            |
| <b>Approves</b> | P.SAWAI        | <b>Date</b>      | 03/07/2025         |

## LIFE\_CN\_DLMV75-750X400X1050

### Colour

05.38 ML MD692 (SS)\_

05.30 ML WHITE SAND #VM1012/2610/2610(PEARL)\_

-

-

-

### Edge

01.286 1 MD692 \_

01.47 1 WHITE \_

-

-

-

|                                     |                   |
|-------------------------------------|-------------------|
| <b>R&amp;D REVIEW</b>               |                   |
| <input checked="" type="checkbox"/> | DWG.Customer      |
| <input checked="" type="checkbox"/> | Work Report       |
| <input type="checkbox"/>            | Function          |
| <input type="checkbox"/>            | สินค้าตรงตัวอย่าง |
| ผู้ทบทวน <u>P.SAWAI</u>             |                   |
| <u>03/07/25</u>                     |                   |

K102L-160166010

K102R-160166018

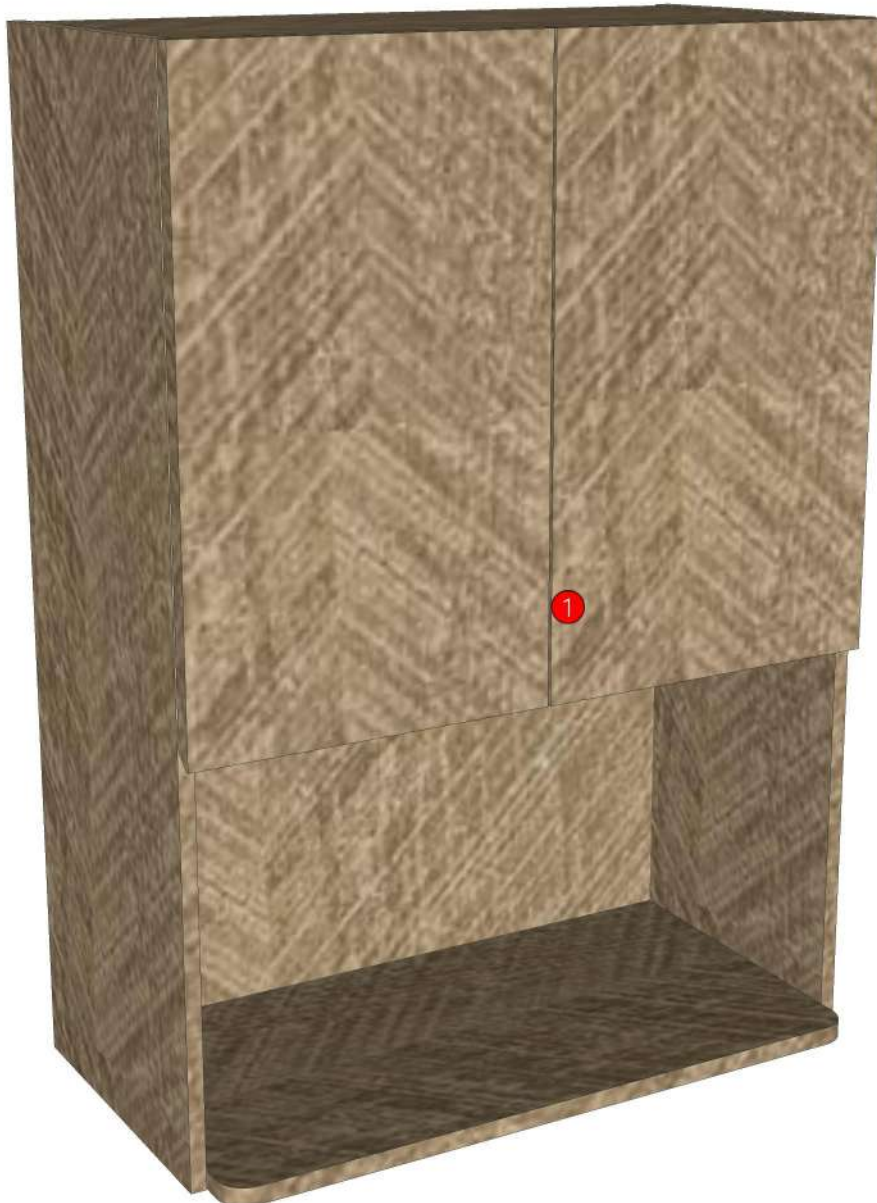

|                 |                 |                  |                    |
|-----------------|-----------------|------------------|--------------------|
| <b>Model</b>    | -LIFE_CN_DLMV75 |                  |                    |
| <b>Creator</b>  |                 | <b>.BCP Name</b> | INDEX_C3D_KITCHEN2 |
| <b>Reviewer</b> |                 | <b>Order</b>     | I004276            |
| <b>Approves</b> | P.SAWAI         | <b>Date</b>      |                    |

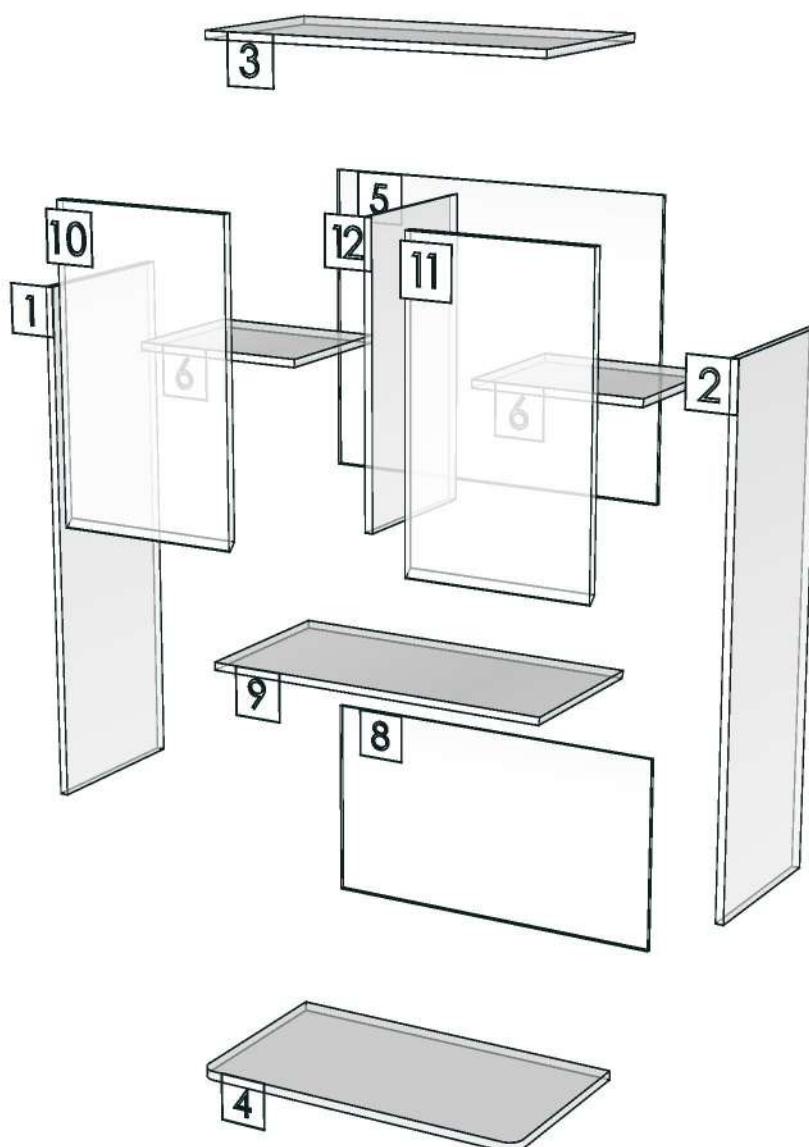

|                 |                  |                  |                    |
|-----------------|------------------|------------------|--------------------|
| <b>Model</b>    | LIFE_CN_D_PLT581 |                  |                    |
| <b>Creator</b>  | PASATHORN        | <b>.BCP Name</b> | INDEX_C3D_KITCHEN2 |
| <b>Reviewer</b> |                  | <b>Order</b>     | I003894            |
| <b>Approves</b> | P.SAWAI          | <b>Date</b>      | 30/01/2025         |

## **LIFE\_CN\_D\_PLT581-581X9X100**

**Colour**

05.38 ML MD692 (SS)\_

-  
-  
-  
-

**Edge**

01.286 1 MD692 \_

-  
-  
-  
-

K101L-160157188

K101R-160166000

|                                     |                   |
|-------------------------------------|-------------------|
| <b>R&amp;D REVIEW</b>               |                   |
| <input checked="" type="checkbox"/> | DWG.Customer      |
| <input checked="" type="checkbox"/> | Work Report       |
| <input type="checkbox"/>            | Function          |
| <input type="checkbox"/>            | สินค้าตรงตัวอย่าง |
| ผู้ทบทวน <u>P.SAWAI</u>             |                   |
| <u>30/01/2025</u>                   |                   |

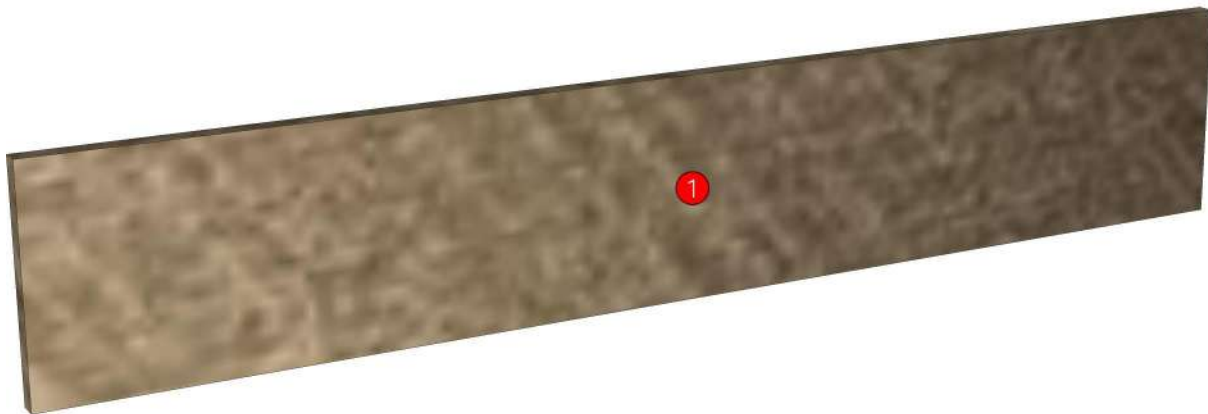

|                 |                  |                  |                    |
|-----------------|------------------|------------------|--------------------|
| <b>Model</b>    | LIFE_CN_D_PLT581 |                  |                    |
| <b>Creator</b>  | PASATHORN        | <b>.BCP Name</b> | INDEX_C3D_KITCHEN2 |
| <b>Reviewer</b> |                  | <b>Order</b>     | I003894            |
| <b>Approves</b> | P.SAWAI          | <b>Date</b>      | 30/01/2025         |

| No. | Article No.         | Description      | Mat   | Dimension | Cutting Size   | Typepology                     | Skin |
|-----|---------------------|------------------|-------|-----------|----------------|--------------------------------|------|
| 0   | LIFE_CN_D_PLT581    | LIFE_CN_D_PLT581 |       | 581x100x9 |                |                                |      |
|     | LIFE_CN_D_PLT581-01 | D_PLINT-SP       | PB-SP | 9x100x581 | 9X98X579;L2:W2 | 183000 _STR=05.38 _EDG=MD692-1 | 2    |

|                 |                  |                  |                    |
|-----------------|------------------|------------------|--------------------|
| <b>Model</b>    | LIFE_CN_D_PLT600 |                  |                    |
| <b>Creator</b>  | PASATHORN        | <b>.BCP Name</b> | INDEX_C3D_KITCHEN2 |
| <b>Reviewer</b> |                  | <b>Order</b>     | I003895            |
| <b>Approves</b> | P.SAWAI          | <b>Date</b>      | 31/01/2025         |

## LIFE\_CN\_D\_PLT600-600X9X100

### Colour

05.38 ML MD692 (SS)\_

-

-

-

K100L-160165993

K100R-160157181

K101L-160157188

K101R-160166000

K102L-160166010

K102R-160166018

K103L-160157198

K104L-160136071

K105L-160136079

### Edge

01.286 1 MD692 \_

-

-

-

-

|                                     |                   |
|-------------------------------------|-------------------|
| <b>R&amp;D REVIEW</b>               |                   |
| <input checked="" type="checkbox"/> | DWG.Customer      |
| <input checked="" type="checkbox"/> | Work Report       |
| <input type="checkbox"/>            | Function          |
| <input type="checkbox"/>            | สินค้าตรงตัวอย่าง |
| ผู้ทบทวน <u>P.SAWAI</u>             |                   |
| <u>31/01/25</u>                     |                   |

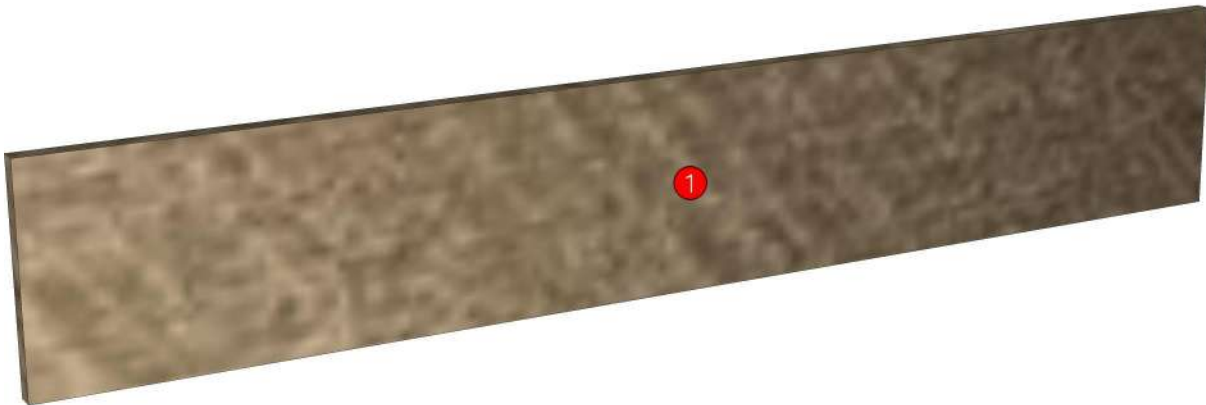

|                 |                  |                  |                    |
|-----------------|------------------|------------------|--------------------|
| <b>Model</b>    | LIFE_CN_D_PLT600 |                  |                    |
| <b>Creator</b>  | PASATHORN        | <b>.BCP Name</b> | INDEX_C3D_KITCHEN2 |
| <b>Reviewer</b> |                  | <b>Order</b>     | I003895            |
| <b>Approves</b> | P.SAWAI          | <b>Date</b>      | 31/01/2025         |

| No. | Article No.         | Description      | Mat   | Dimension | Cutting Size   | Typepology                     | Skin |
|-----|---------------------|------------------|-------|-----------|----------------|--------------------------------|------|
| 0   | LIFE_CN_D_PLT600    | LIFE_CN_D_PLT600 |       | 600x100x9 |                |                                |      |
|     | LIFE_CN_D_PLT600-01 | D_PLINT-SP       | PB-SP | 9x100x600 | 9X98X598;L2:W2 | 183000 _STR=05.38 _EDG=MD692-1 | 2    |

|                 |                  |                  |                    |
|-----------------|------------------|------------------|--------------------|
| <b>Model</b>    | LIFE_CN_D_PLT800 |                  |                    |
| <b>Creator</b>  | PASATHORN        | <b>.BCP Name</b> | INDEX_C3D_KITCHEN2 |
| <b>Reviewer</b> |                  | <b>Order</b>     | I003897            |
| <b>Approves</b> | P.SAWAI          | <b>Date</b>      | 31/01/2025         |

## LIFE\_CN\_D\_PLT800-800X9X100

### Colour

05.38 ML MD692 (SS)\_

-  
-  
-  
-

### Edge

01.286 1 MD692 \_

-  
-  
-  
-

|                                     |                   |
|-------------------------------------|-------------------|
| <b>R&amp;D REVIEW</b>               |                   |
| <input checked="" type="checkbox"/> | DWG.Customer      |
| <input checked="" type="checkbox"/> | Work Report       |
| <input type="checkbox"/>            | Function          |
| <input type="checkbox"/>            | สินค้าตรงตัวอย่าง |
| ผู้ทบทวน <u>P.SAWAI</u>             |                   |
| <u>31/01/25</u>                     |                   |

K102L-160166010

K102R-160166018

K103L-160157198

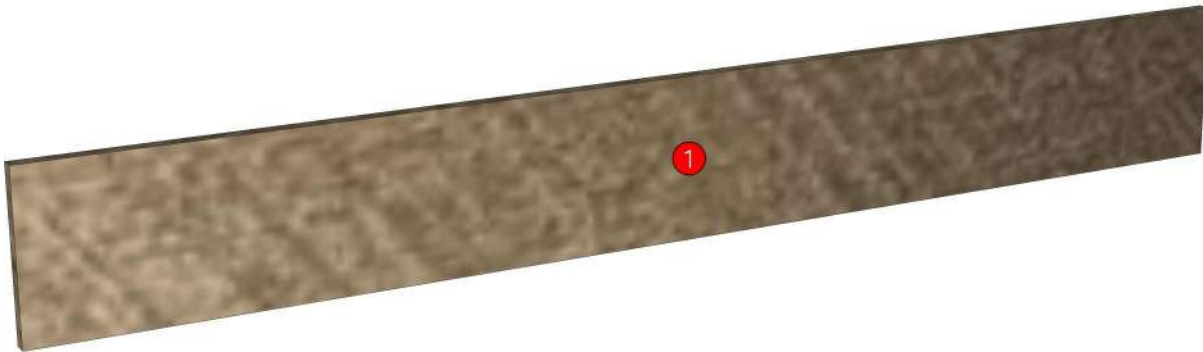

|                 |                  |                  |                    |
|-----------------|------------------|------------------|--------------------|
| <b>Model</b>    | LIFE_CN_D_PLT800 |                  |                    |
| <b>Creator</b>  | PASATHORN        | <b>.BCP Name</b> | INDEX_C3D_KITCHEN2 |
| <b>Reviewer</b> |                  | <b>Order</b>     | I003897            |
| <b>Approves</b> | P.SAWAI          | <b>Date</b>      | 31/01/2025         |

| No. | Article No.         | Description      | Mat   | Dimension | Cutting Size   | Typepology                   | Skin |
|-----|---------------------|------------------|-------|-----------|----------------|------------------------------|------|
| 0   | LIFE_CN_D_PLT800    | LIFE_CN_D_PLT800 |       | 800x100x9 |                |                              |      |
|     | LIFE_CN_D_PLT800-01 | D_PLINT-SP       | PB-SP | 9x100x800 | 9X98X798;L2:W2 | 183000_STR=05.38_EDG=MD692-1 | 2    |