

<b>Model</b>	CO_RM9_DBH602		
<b>Creator</b>	CHALEAMPHON	<b>.BCP Name</b>	INDEX_C3D_KITCHEN2
<b>Reviewer</b>		<b>Order</b>	H001647
<b>Approves</b>		<b>Date</b>	21/04/2025

## CO\_RM9\_DBH602-600X570X808

### Colour

20.39=ML WARM ROVERE AJ1 (WOODRIFT)  
20.44=ML WHITE VM1012/2610/2610 (PEAEL)  
03.11=PVC 0.15 WHITE SAND #DFS7T06 (MALT)  
06.01=TEXTURE DEAD STOCK

### Edge

01.257=1 AJ1  
01.47=1 WHITE



- K1L-160159960
- K1R-160159968
- K7R-160159986
- K9L-160159996
- K10L-160160007
- K11R-160160021
- K12R-160160034
- K13L-160160046
- K14L-160160062
- K18L-160160095
- K41L-160160107
- K43R-160160120
- K45L-160160128
- K45R-160160136
- K46L-160160144
- K47L-160160154
- K47R-160160164



<b>Model</b>	-CO_RM9		
<b>Creator</b>	CHALEAMPHON	<b>.BCP Name</b>	INDEX_C3D_KITCHEN2
<b>Reviewer</b>		<b>Order</b>	H001647
<b>Approves</b>		<b>Date</b>	21/04/2025

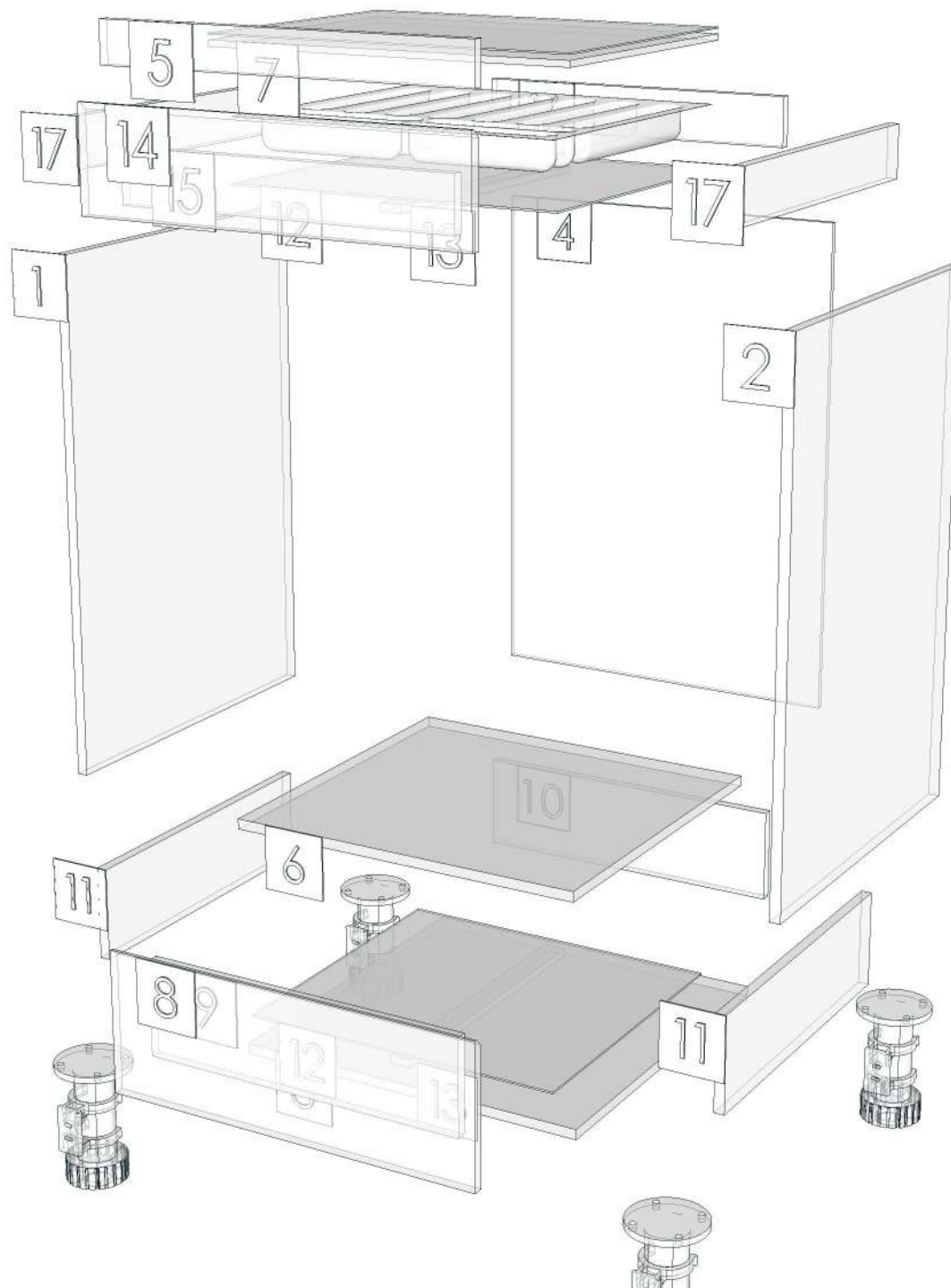

<b>Model</b>	CO_RM9_DBO215(S)		
<b>Creator</b>	CHALEAMPHON	<b>.BCP Name</b>	INDEX_C3D_KITCHEN2
<b>Reviewer</b>		<b>Order</b>	H001729
<b>Approves</b>		<b>Date</b>	22/05/2025

## **CO\_RM9\_DBO215(S)-215X570X808**

### **Colour**

20.39=ML WARM ROVERE AJ1 (WOODRIFT)  
20.44=ML WHITE VM1012/2610/2610 (PEAEL)  
03.11=PVC 0.15 WHITE SAND #DFS7T06 (MALT)

### **Edge**

01.257=1 AJ1  
01.47=1 WHITE



K12R-160160034

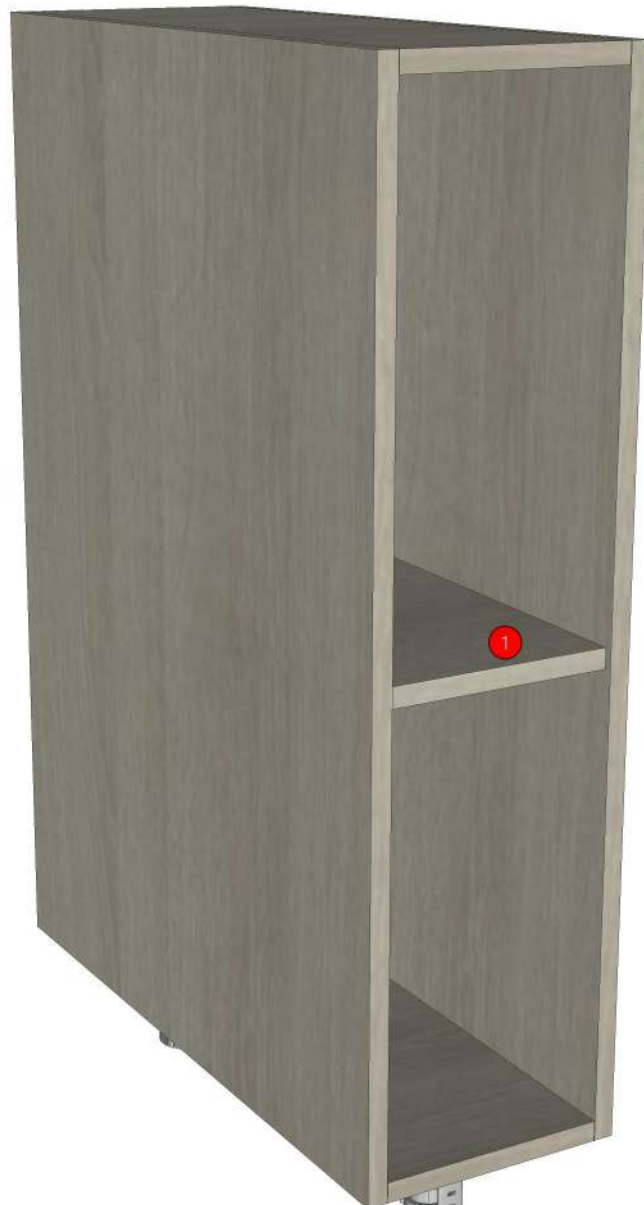

<b>Model</b>	-CO_RM9		
<b>Creator</b>	CHALEAMPHON	<b>.BCP Name</b>	INDEX_C3D_KITCHEN2
<b>Reviewer</b>		<b>Order</b>	H001729
<b>Approves</b>		<b>Date</b>	22/05/2025

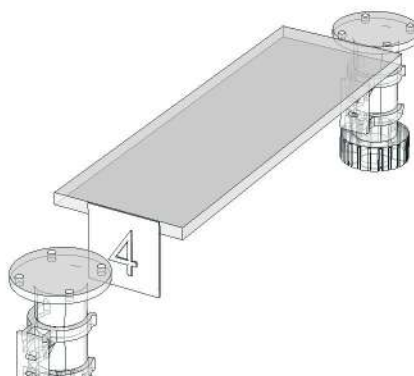
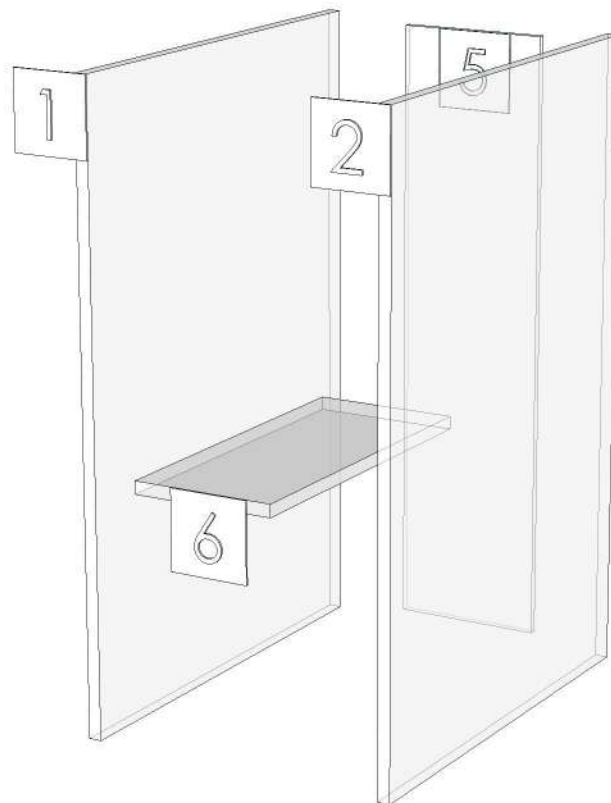
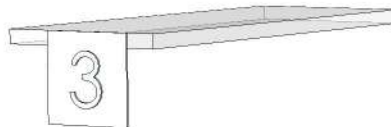

<b>Model</b>	CO_RM9_DBS60R		
<b>Creator</b>	CHALEAMPHON	<b>.BCP Name</b>	INDEX_C3D_KITCHEN2
<b>Reviewer</b>		<b>Order</b>	H001733
<b>Approves</b>		<b>Date</b>	24/05/2025

## **CO\_RM9\_DBS60R-600X570X808**

### **Colour**

20.39=ML WARM ROVERE AJ1 (WOODRIFT)  
20.44=ML WHITE VM1012/2610/2610 (PEAEL)  
03.11=PVC 0.15 WHITE SAND #DFS7T06 (MALT)

### **Edge**

01.257=1 AJ1  
01.47=1 WHITE



K11R-160160021  
K12R-160160034



<b>Model</b>	-CO RM9		
<b>Creator</b>	CHALEAMPHON	<b>.BCP Name</b>	INDEX_C3D_KITCHEN2
<b>Reviewer</b>		<b>Order</b>	H001733
<b>Approves</b>		<b>Date</b>	24/05/2025

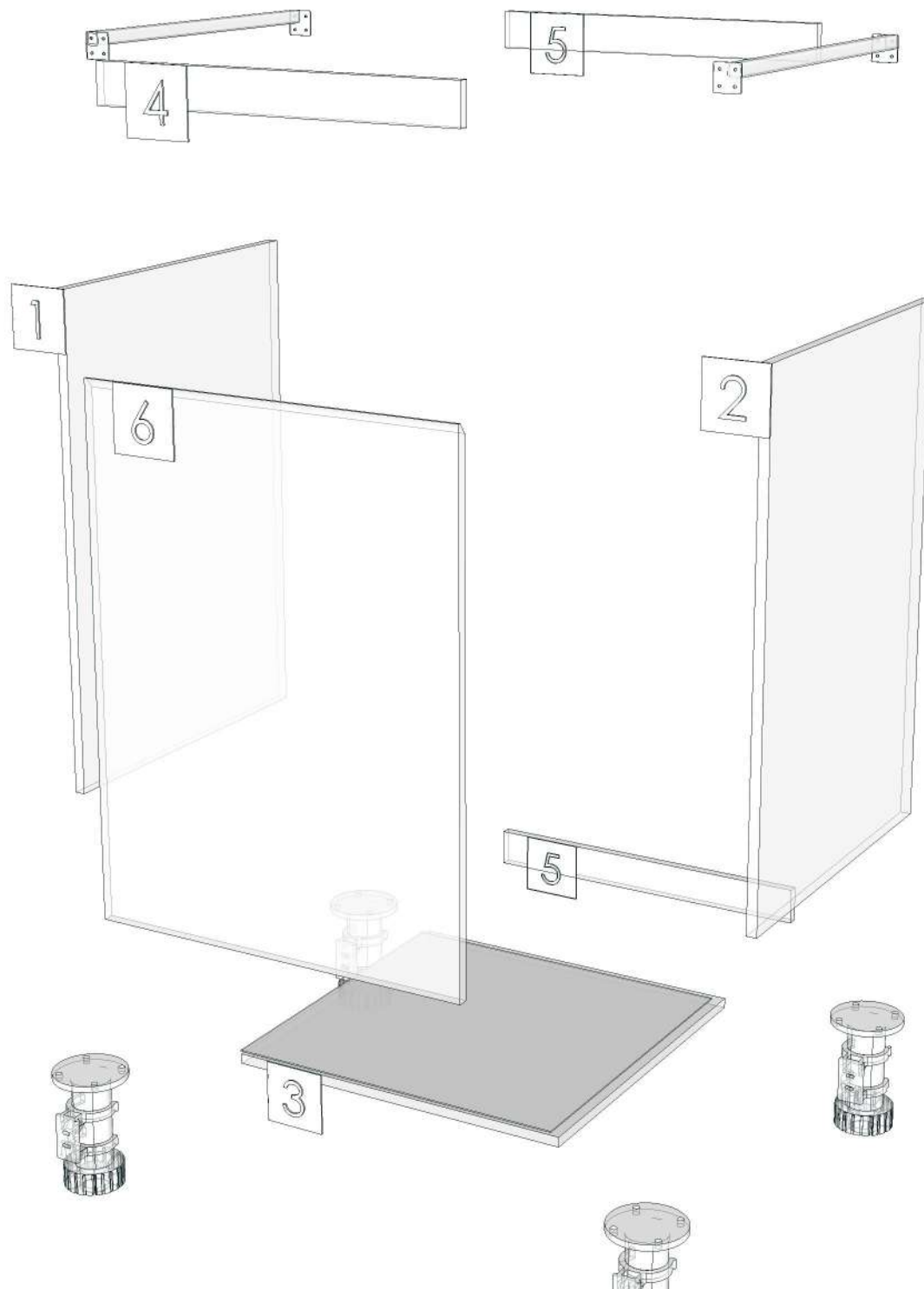

<b>Model</b>	CO_RM9_DFCL_1425AJ		
<b>Creator</b>	CHALEAMPON	<b>.BCP Name</b>	INDEX_C3D_KITCHEN2
<b>Reviewer</b>		<b>Order</b>	H001745
<b>Approves</b>		<b>Date</b>	27/05/2025

## **CO\_RM9\_DFCL\_1425AJ-1425X9X130**

**Colour**

20.39=ML WARM ROVERE AJ1 (WOODRIFT)

**Edge**

01.257=1 AJ1



K10L-160160007

K12R-160160034

K13L-160160046

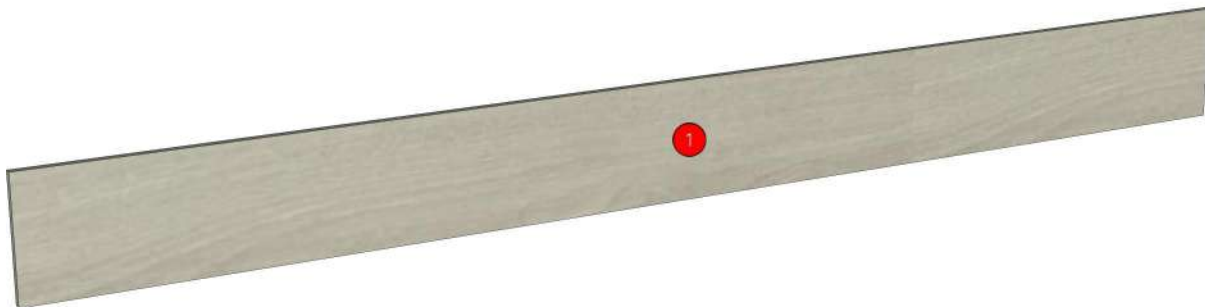

<b>Model</b>	CO_RM9_DFCL_1425AJ		
<b>Creator</b>	CHALEAMPHON	<b>.BCP Name</b>	INDEX_C3D_KITCHEN2
<b>Reviewer</b>		<b>Order</b>	H001745
<b>Approves</b>		<b>Date</b>	27/05/2025

No.	Article No.	Description	Mat	Dimension	Cutting Size	Typepology	Skin
0	CO_RM9_DFCL_1425AJ			1425x130x9			
	CO_RM9_DFCL_1425AJ-01	FILLER TOP	PB-SP	9x130x1425	9X129X1423;L1:W2	183000_STR=20.39_EDG=AJ1-1	2

<b>Model</b>	CO_RM9_DFCL_300AJ		
<b>Creator</b>	CHALEAMPON	<b>.BCP Name</b>	INDEX_C3D_KITCHEN2
<b>Reviewer</b>		<b>Order</b>	H001751
<b>Approves</b>		<b>Date</b>	27/05/2025

## **CO\_RM9\_DFCL\_300AJ-300X9X130**

**Colour**

20.39=ML WARM ROVERE AJ1 (WOODRIFT)

**Edge**

01.257=1 AJ1



- K7R-160159986
- K10L-160160007
- K12R-160160034
- K13L-160160046
- K14L-160160062
- K46L-160160144
- K47L-160160154
- K47R-160160164

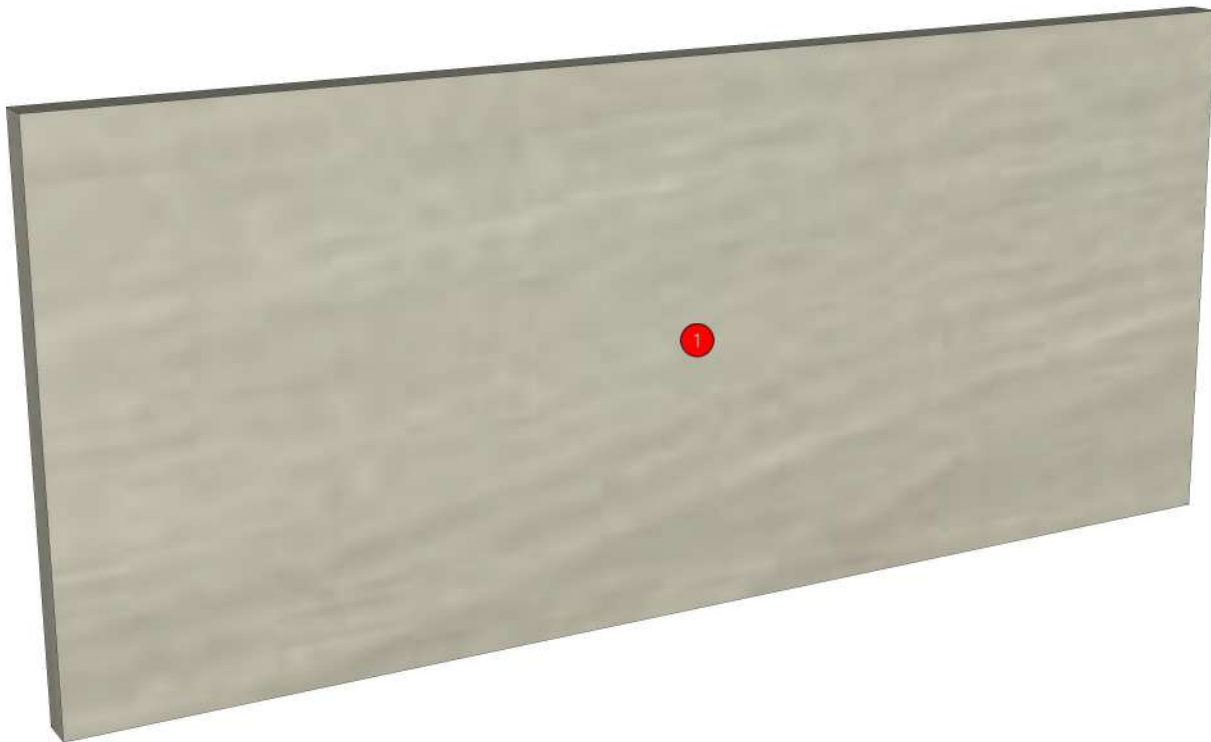

<b>Model</b>	CO_RM9_DFCL_300AJ		
<b>Creator</b>	CHALEAMPHON	<b>.BCP Name</b>	INDEX_C3D_KITCHEN2
<b>Reviewer</b>		<b>Order</b>	H001751
<b>Approves</b>		<b>Date</b>	27/05/2025

No.	Article No.	Description	Mat	Dimension	Cutting Size	Typepology	Skin
0	CO_RM9_DFCL_300AJ			300x130x9			
	CO_RM9_DFCL_300AJ-01	FILLER TOP	PB-SP	9x130x300	9X129X298;L1:W2	183000_STR=20.39_EDG=AJ1-1	2

<b>Model</b>	CO_RM9_DL60HL		
<b>Creator</b>	CHALEAMPON	<b>.BCP Name</b>	INDEX_C3D_KITCHEN2
<b>Reviewer</b>		<b>Order</b>	H001651
<b>Approves</b>		<b>Date</b>	23/04/2025

## CO\_RM9\_DL60HL-600X300X660

### Colour

05.96=ML.WHITE NORDIC ELM BS9 (MATT WOODGRAIN)

20.44=ML WHITE VM1012/2610/2610 (PEAEL)

03.11=PVC 0.15 WHITE SAND #DFS7T06 (MALT)

### Edge

01.366=1 BS9

01.47=1 WHITE



- K1R-160159968
- K7R-160159986
- K11R-160160021
- K12R-160160034
- K43R-160160120
- K45R-160160136
- K47R-160160164
- K22R-1601
- K23R-1601
- K24R-1601
- K35R-1601
- K48R-1601
- K53R-1601
- K55R-1601



<b>Model</b>	-CO RM9		
<b>Creator</b>	CHALEAMPON	<b>.BCP Name</b>	INDEX_C3D_KITCHEN2
<b>Reviewer</b>		<b>Order</b>	H001651
<b>Approves</b>		<b>Date</b>	23/04/2025

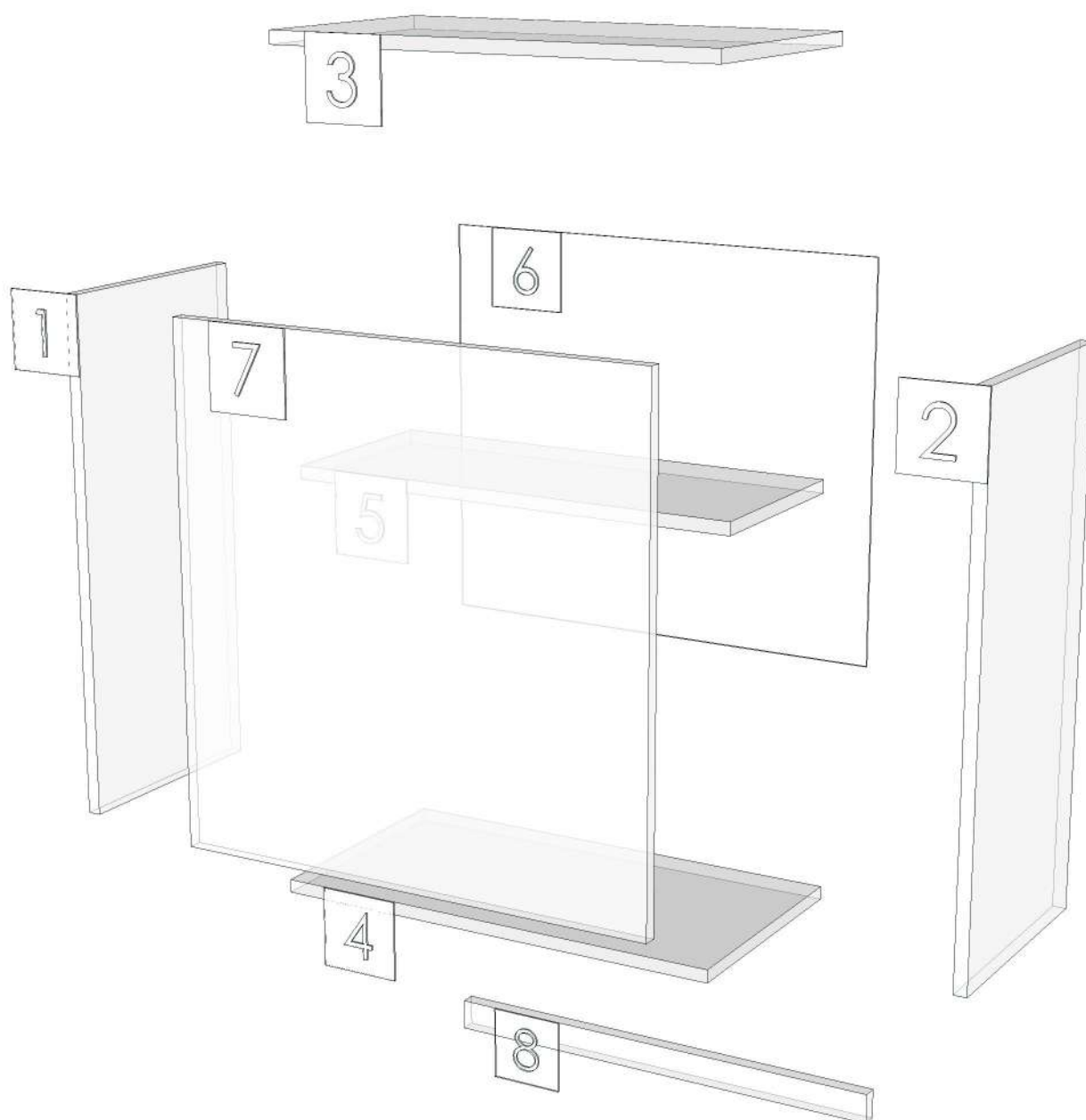

<b>Model</b>	CO_RM9_DL60R		
<b>Creator</b>	CHALEAMPHON	<b>.BCP Name</b>	INDEX_C3D_KITCHEN2
<b>Reviewer</b>		<b>Order</b>	H001650
<b>Approves</b>		<b>Date</b>	23/04/2025

## **CO\_RM9\_DL60R-600X300X700**

### **Colour**

05.96=ML.WHITE NORDIC ELM BS9 (MATT WOODGRAIN)  
20.44=ML WHITE VM1012/2610/2610 (PEAEL)  
03.11=PVC 0.15 WHITE SAND #DFS7T06 (MALT)

### **Edge**

01.366=1 BS9  
01.47=1 WHITE



- K1R-160159968
- K11L-160160021
- K12R-160160034
- K14L-160160062
- K43R-160160120
- K45R-160160136
- K42R-160163061
- K49R-160163076
- K20L-1601
- K23R-1601
- K36R-1601
- K37R-1601
- K40R-1601
- K48R-1601
- K56R-1601



<b>Model</b>	-CO RM9		
<b>Creator</b>	CHALEAMPON	<b>.BCP Name</b>	INDEX_C3D_KITCHEN2
<b>Reviewer</b>		<b>Order</b>	H001650
<b>Approves</b>		<b>Date</b>	23/04/2025

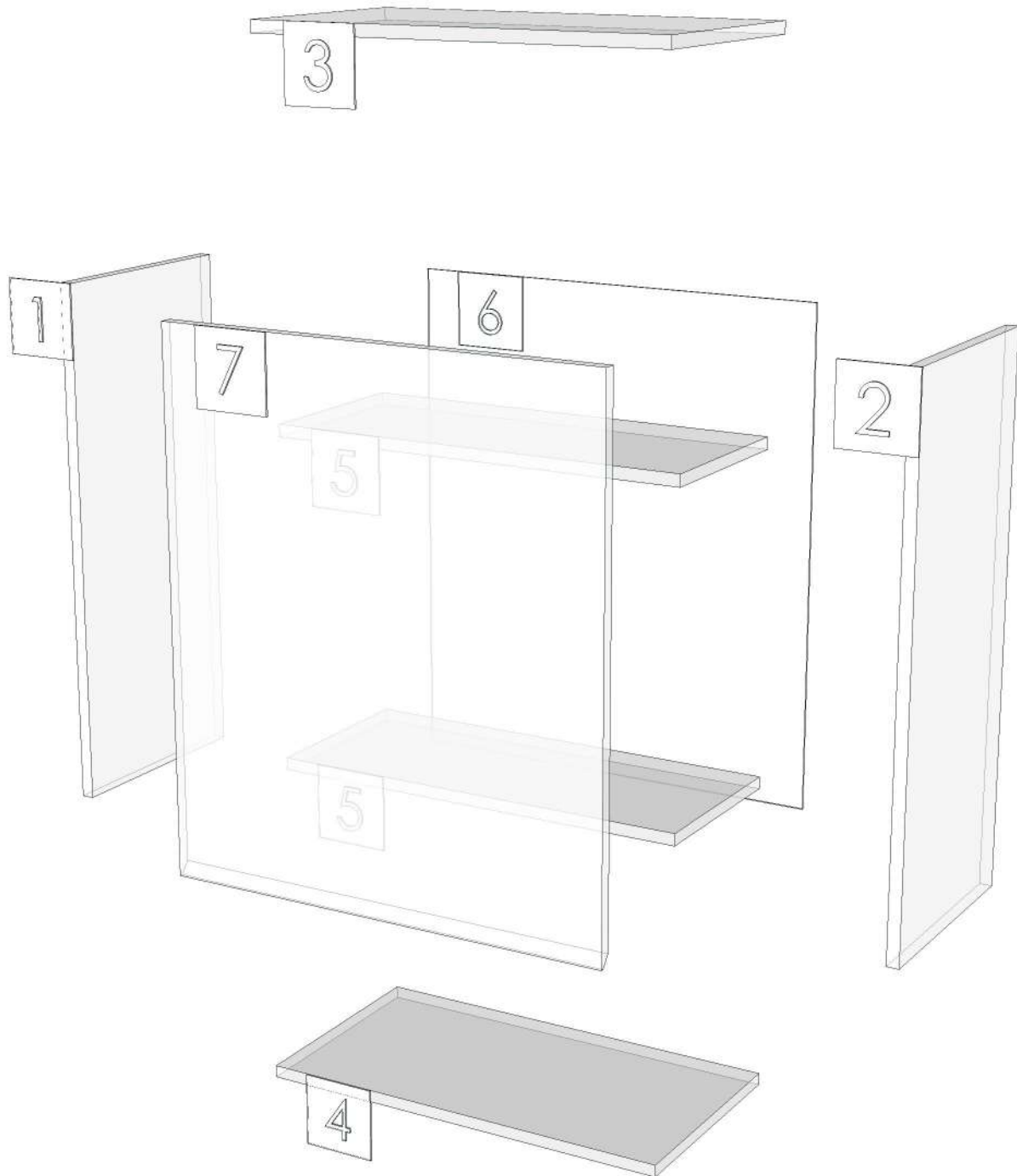

<b>Model</b>	CO_RM9_DLO22.5(S)		
<b>Creator</b>	CHALEAMPON	<b>.BCP Name</b>	INDEX_C3D_KITCHEN2
<b>Reviewer</b>		<b>Order</b>	H001708
<b>Approves</b>		<b>Date</b>	14/05/2025

## **CO\_RM9\_DLO22.5(S)-225X300X700**

**Colour**

05.96=ML.WHITE NORDIC ELM BS9 (MATT WOODGRAIN)

**Edge**

01.366=1 BS9



K12R-160160034

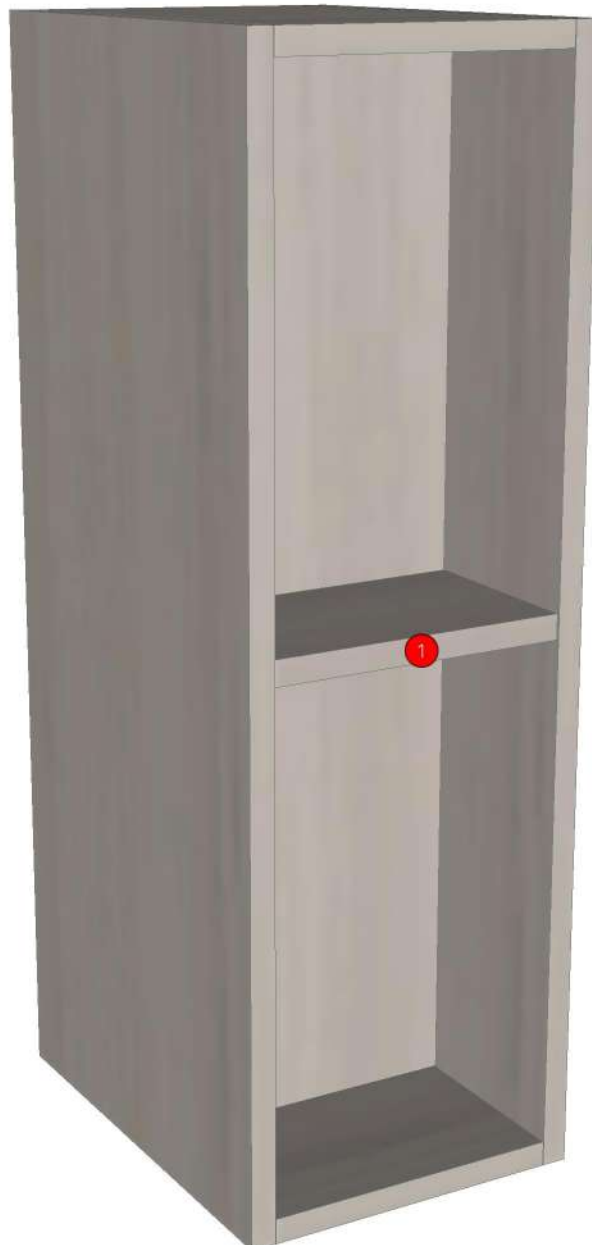

<b>Model</b>	-CO RM9		
<b>Creator</b>	CHALEAMPHON	<b>.BCP Name</b>	INDEX_C3D_KITCHEN2
<b>Reviewer</b>		<b>Order</b>	H001708
<b>Approves</b>		<b>Date</b>	14/05/2025

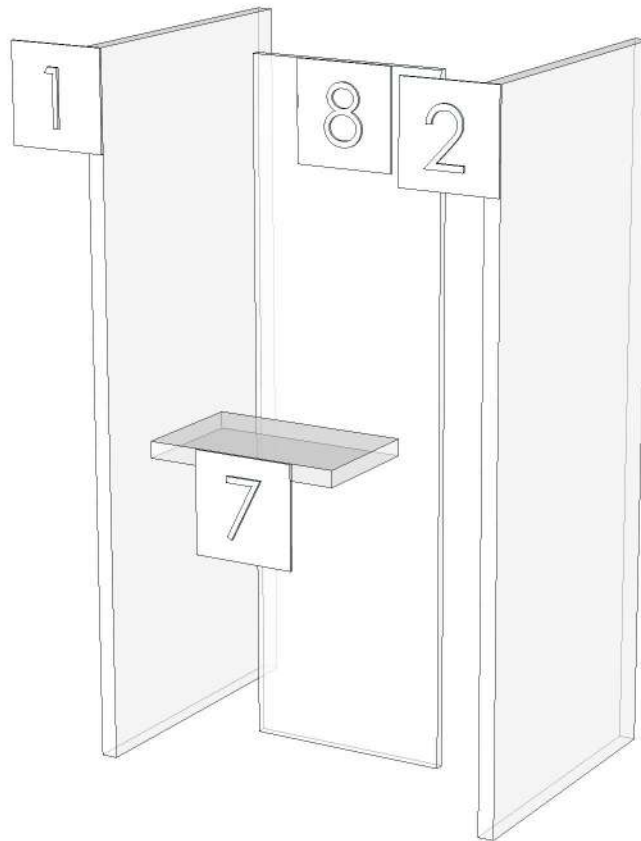
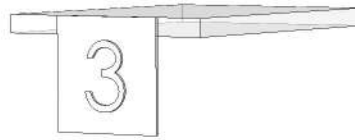

<b>Model</b>	CO_RM9_DPLT_1415		
<b>Creator</b>	CHALEAMPON	<b>.BCP Name</b>	INDEX_C3D_KITCHEN2
<b>Reviewer</b>		<b>Order</b>	H001773
<b>Approves</b>		<b>Date</b>	28/05/2025

## **CO\_RM9\_DPLT\_1415-1415X9X100**

**Colour**

20.39=ML WARM ROVERE AJ1 (WOODRIFT)

**Edge**

01.257=1 AJ1



K12R-160160034

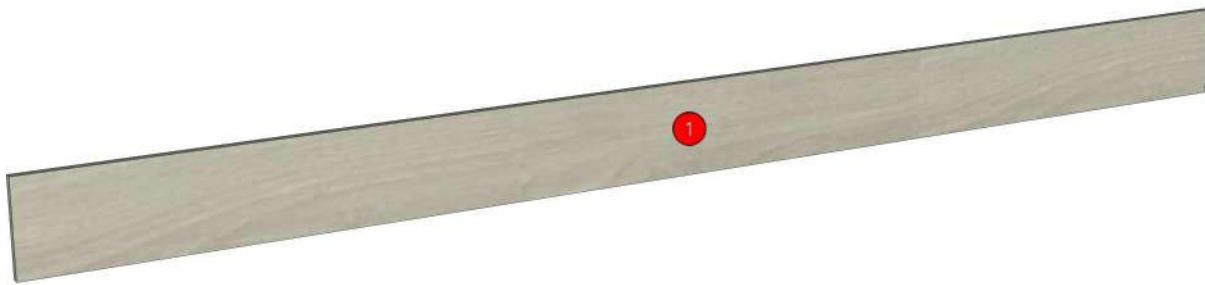

<b>Model</b>	CO_RM9_DPLT_1415		
<b>Creator</b>	CHALEAMPHON	<b>.BCP Name</b>	INDEX_C3D_KITCHEN2
<b>Reviewer</b>		<b>Order</b>	H001773
<b>Approves</b>		<b>Date</b>	28/05/2025

No.	Article No.	Description	Mat	Dimension	Cutting Size	Typepology	Skin
0	CO_RM9_DPLT_1415			1415x100x9			
	CO_RM9_DPLT_1415-01	LED BOTTOM	PB-SP	9x100x1415	9X98X1413;L2:W2	183000_STR=20.39_EDG=AJ1-1	2

<b>Model</b>	CO_RM9_DPLT_517		
<b>Creator</b>	CHALEAMPON	<b>.BCP Name</b>	INDEX_C3D_KITCHEN2
<b>Reviewer</b>		<b>Order</b>	H001777
<b>Approves</b>		<b>Date</b>	28/05/2025

## **CO\_RM9\_DPLT\_517-517X9X100**

**Colour**

20.39=ML WARM ROVERE AJ1 (WOODRIFT)

**Edge**

01.257=1 AJ1



K10L-160160007

K12R-160160034

K13L-160160146

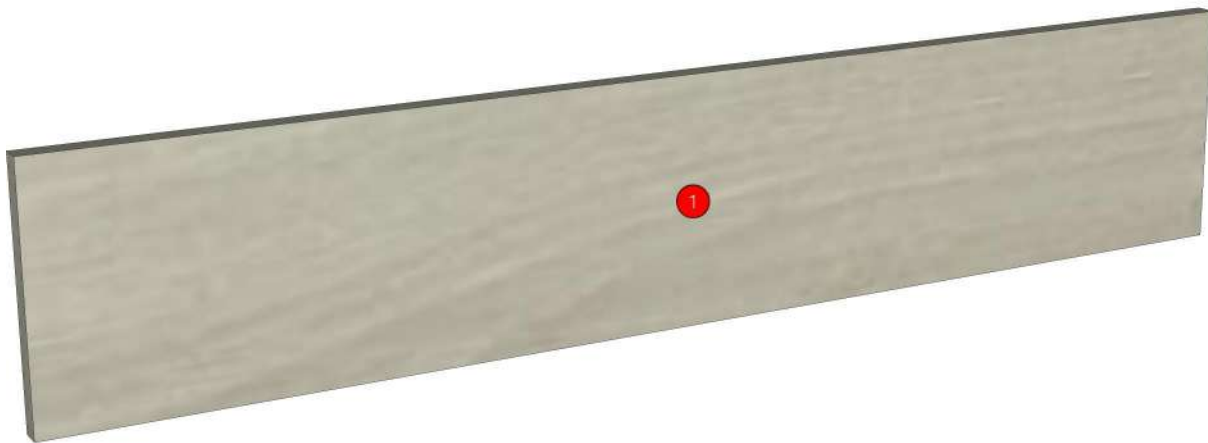

<b>Model</b>	CO_RM9_DPLT_517		
<b>Creator</b>	CHALEAMPHON	<b>.BCP Name</b>	INDEX_C3D_KITCHEN2
<b>Reviewer</b>		<b>Order</b>	H001777
<b>Approves</b>		<b>Date</b>	28/05/2025

No.	Article No.	Description	Mat	Dimension	Cutting Size	Typepology	Skin
0	CO_RM9_DPLT_517			517x100x9			
	CO_RM9_DPLT_517-01	LED BOTTOM	PB-SP	9x100x517	9X98X515;L2:W2	183000_STR=20.39_EDG=AJ1-1	2

<b>Model</b>	CO_RM9_DPLT_600		
<b>Creator</b>	CHALEAMPHON	<b>.BCP Name</b>	INDEX_C3D_KITCHEN2
<b>Reviewer</b>		<b>Order</b>	H001601
<b>Approves</b>		<b>Date</b>	06/03/2025

## CO\_RM9\_DPLT\_600-600X9X100

**Colour**

20.39=ML WARM ROVERE AJ1 (WOODRIFT)

**Edge**

01.257=1 AJ1

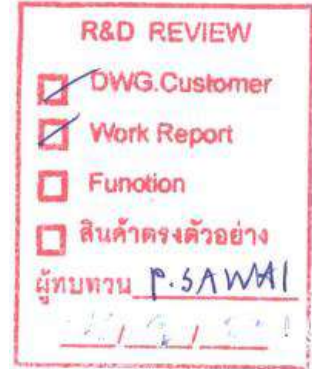

- K1L-160159960
- K1R-160159968
- K2R-160159976
- K7R-160159986
- K9L-160159996
- K10L-160160007
- K11R-160160021
- K12R-160160034
- K14L-160160062
- K15L-160160073
- K16R-160160085
- K18L-160160095
- K41L-160160107
- K43R-160160120
- K45L-160160128
- K45R-160160136
- K46L-160160144
- K47L-160160154
- K47R-160160164

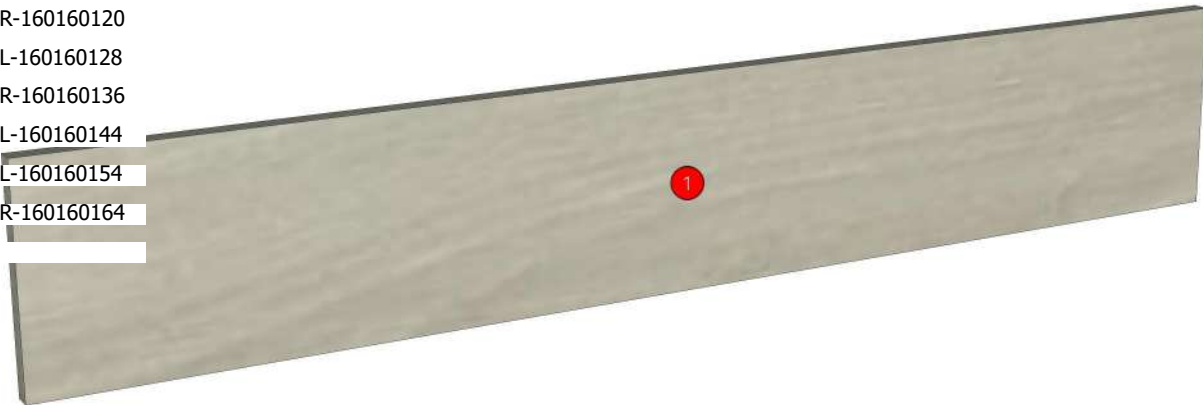

<b>Model</b>	CO_RM9_DPLT_600		
<b>Creator</b>	CHALEAMPON	<b>.BCP Name</b>	INDEX_C3D_KITCHEN2
<b>Reviewer</b>		<b>Order</b>	H001601
<b>Approves</b>		<b>Date</b>	06/03/2025

No.	Article No.	Description	Mat	Dimension	Cutting Size	Typepology	Skin
0	CO_RM9_DPLT_600			600x100x9			
	CO_RM9_DPLT_600-01	LED BOTTOM	PB-SP	9x100x600	9X98X598;L2:W2	183000_STR=20.39_EDG=AJ1-1	2

<b>Model</b>	CO_RM9_DT55(C)L		
<b>Creator</b>	CHALEAMPHON	<b>.BCP Name</b>	INDEX_C3D_KITCHEN2
<b>Reviewer</b>		<b>Order</b>	H001783
<b>Approves</b>		<b>Date</b>	03/06/2025

## **CO\_RM9\_DT55(C)L-550X300X2220**

### **Colour**

20.39=ML WARM ROVERE AJ1 (WOODRIFT)  
05.96=ML.WHITE NORDIC ELM BS9 (MATT WOODGRAIN)  
20.44=ML WHITE VM1012/2610/2610 (PEAEL)  
03.11=PVC 0.15 WHITE SAND #DFS7T06 (MALT)

### **Edge**

01.257=1 AJ1  
01.366=1 BS9  
01.47=1 WHITE

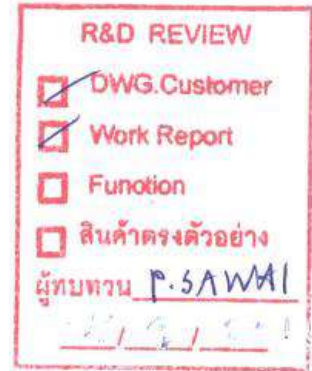

K12R-160160034

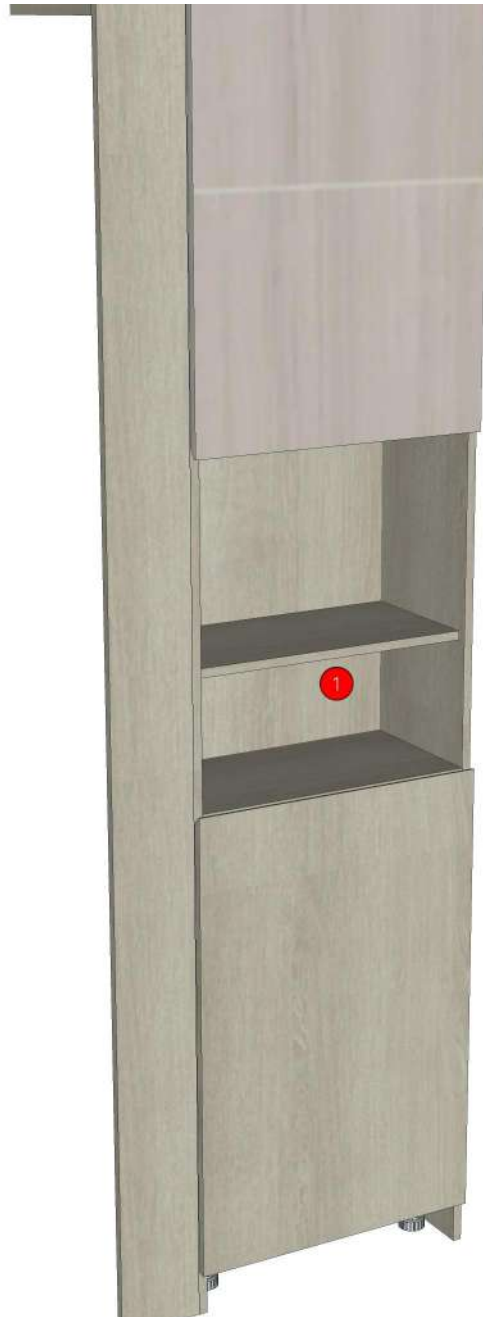

<b>Model</b>	-CO_RM9		
<b>Creator</b>	CHALEAMPON	<b>.BCP Name</b>	INDEX_C3D_KITCHEN2
<b>Reviewer</b>		<b>Order</b>	H001783
<b>Approves</b>		<b>Date</b>	03/06/2025

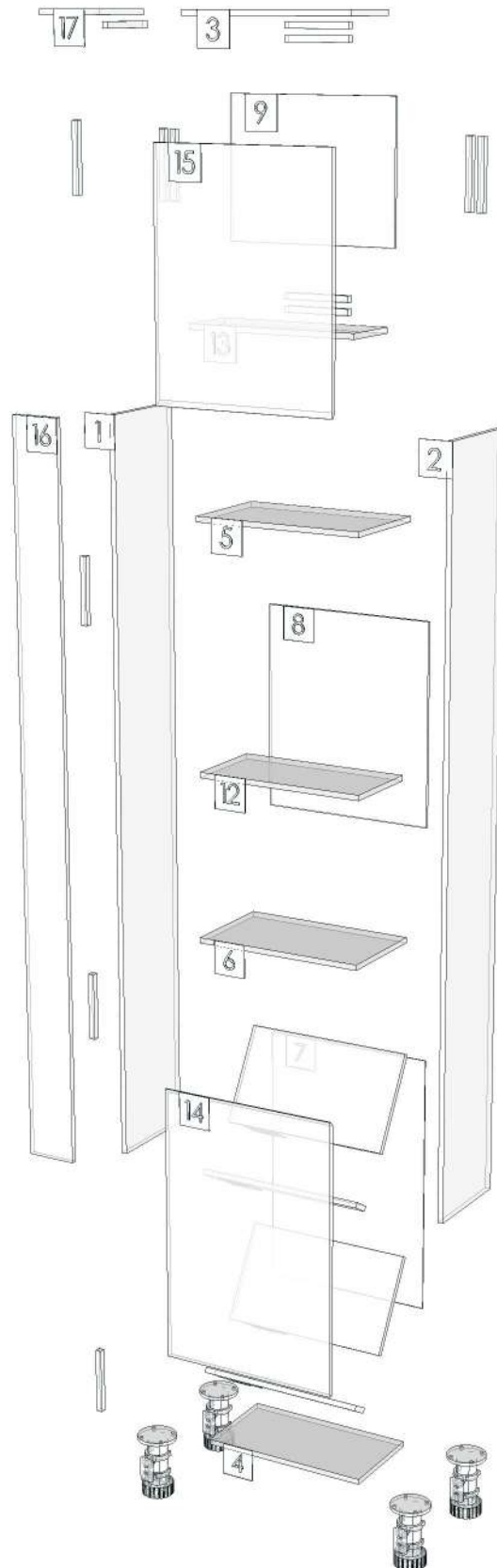

<b>Model</b>	CO_RM9_DW70		
<b>Creator</b>	CHALEAMPHON	<b>.BCP Name</b>	INDEX_C3D_KITCHEN2
<b>Reviewer</b>		<b>Order</b>	H001662
<b>Approves</b>		<b>Date</b>	28/04/2025

## CO\_RM9\_DW70-700X300X400

### Colour

05.96=ML.WHITE NORDIC ELM BS9 (MATT WOODGRAIN)

20.24=ML AE9V (PEARL)

03.11=PVC 0.15 WHITE SAND #DFS7T06 (MALT)

### Edge

01.366=1 BS9

01.47=1 WHITE



K10L-160160007

K11R-160160021

K12R-160160034

K41L-160160107

K43R-160160120

K42R-160163061

K4R-1601

K23L-1601

K23R-1601

K33R-1601

K35R-1601

K36R-1601

K39L-1601

K54L-1601

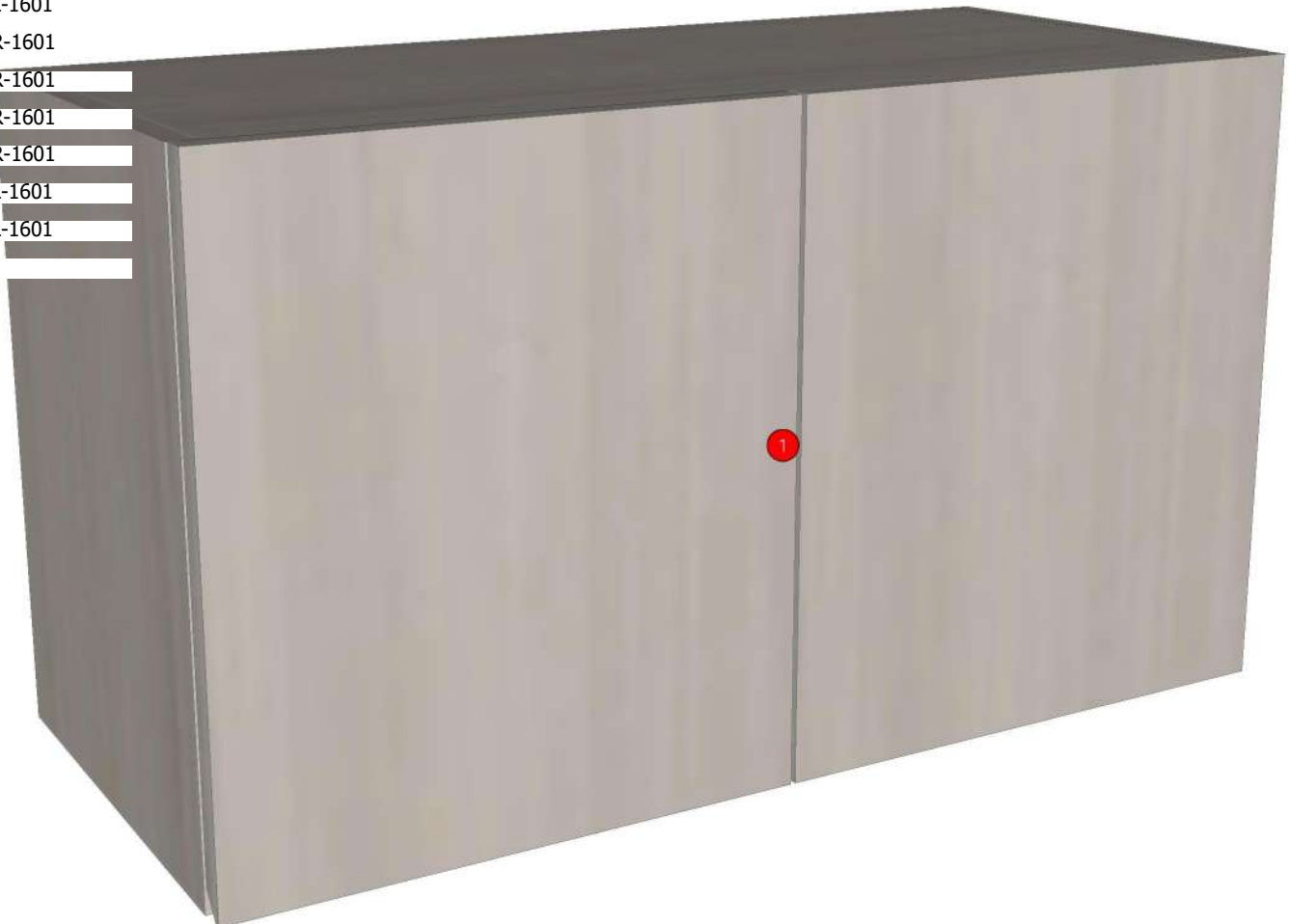

<b>Model</b>	-CO RM9		
<b>Creator</b>	CHALEAMPHON	<b>.BCP Name</b>	INDEX_C3D_KITCHEN2
<b>Reviewer</b>		<b>Order</b>	H001662
<b>Approves</b>		<b>Date</b>	28/04/2025

