

Model	LANDMARK_TSH_DB140R		
Creator	PASATHORN	.BCP Name	INDEX_C3D_KITCHEN2
Reviewer		Order	I004096
Approves		Date	28/04/2025

LANDMARK_TSH_DB140R-1500X580X830

Colour

30.47=HPL HMR LAMINATE WINSONART NO.6826-29 (WET PROTECT

Edge

01.446=1 6826-29 (MW40-A1963TH00)

K1R-160159910

R&D REVIEW	
<input checked="" type="checkbox"/>	DWG.Customer
<input checked="" type="checkbox"/>	Work Report
<input type="checkbox"/>	Function
<input type="checkbox"/>	สินค้าตรงตัวอย่าง
ผู้ทบทวน _____	

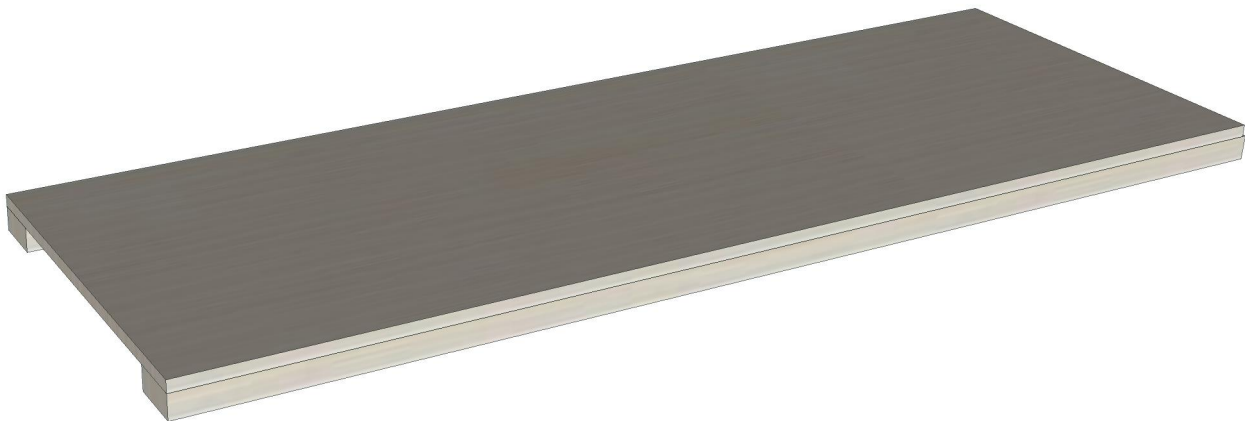
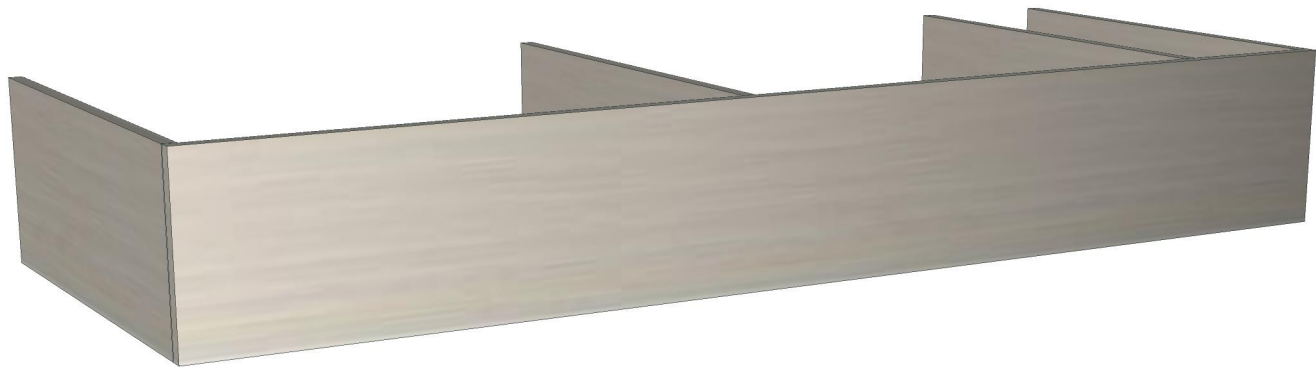

Model	-LANDMARK_TSH_DB140R		
Creator		.BCP Name	INDEX_C3D_KITCHEN2
Reviewer		Order	I004096
Approves		Date	

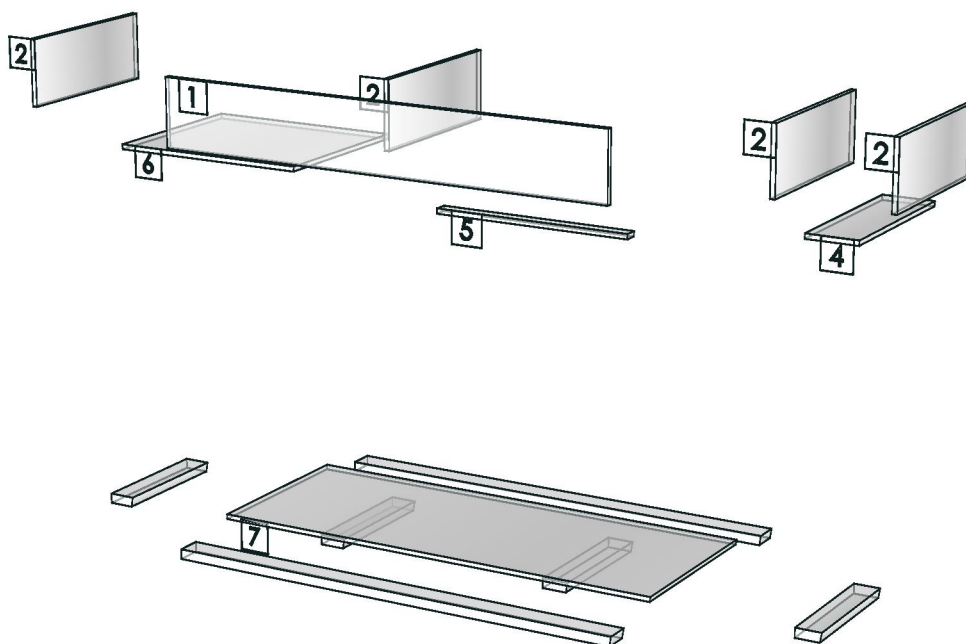

Model	LANDMARK_TSH_DDMK1		
Creator	PASATHORN	.BCP Name	INDEX_C3D_KITCHEN2
Reviewer		Order	I004084
Approves	P.SAWAI	Date	23/04/2025

LANDMARK_TSH_DDMK1-1500X9X2450

Colour

30.47=HPL HMR LAMINATE WINSONART NO.6826-29 (WET PROTECT

Edge

01.446=1 6826-29 (MW40-A1963TH00)

K1L-160159905

K1R-160159910

R&D REVIEW	
<input checked="" type="checkbox"/>	DWG.Customer
<input checked="" type="checkbox"/>	Work Report
<input type="checkbox"/>	Function
<input type="checkbox"/>	สินค้าตรงตัวอย่าง
ผู้ทบทวน <u>P.SAWAI</u>	
<u>23/4/25</u>	

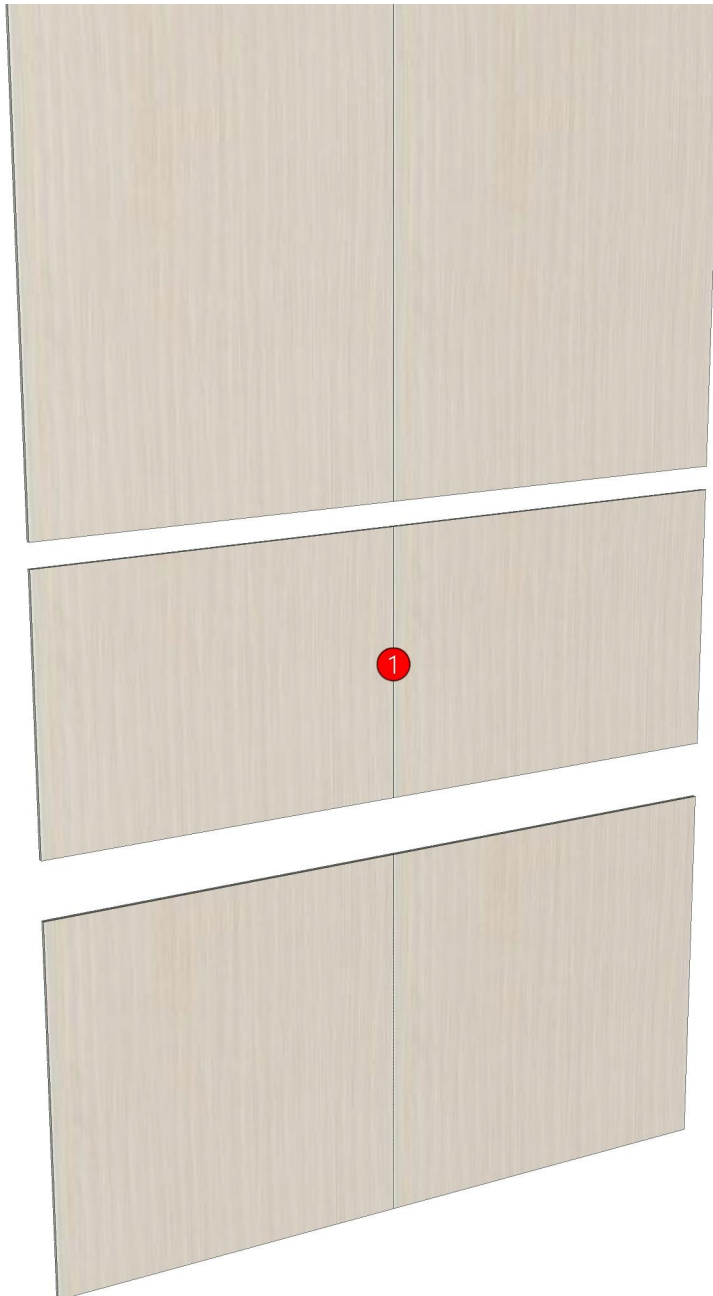

Model	-LANDMARK_TSH_DDMK1		
Creator		.BCP Name	INDEX_C3D_KITCHEN2
Reviewer		Order	I004084
Approves	P.SAWAI	Date	

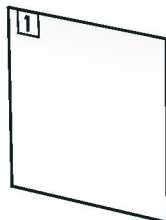
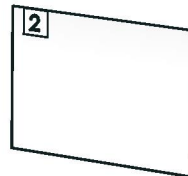
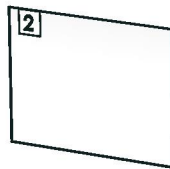

Model	LANDMARK_TSH_DSH1400		
Creator	PASATHORN	.BCP Name	INDEX_C3D_KITCHEN2
Reviewer		Order	I004089
Approves	P.SAWAI	Date	24/04/2025

LANDMARK_TSH_DSH1400-1440X400X50

Colour

30.47=HPL HMR LAMINATE WINSONART NO.6826-29 (WET PROTECT
NOTXTE3=NO TEXTURE HMR

Edge

01.446=1 6826-29 (MW40-A1963TH00)

K1L-160159905

K1R-160159910

R&D REVIEW	
<input checked="" type="checkbox"/>	DWG.Customer
<input checked="" type="checkbox"/>	Work Report
<input type="checkbox"/>	Function
<input type="checkbox"/>	สินค้าตรงตัวอย่าง
ผู้ทบทวน <u>P.SAWAI</u>	
<u>25/4/25</u>	

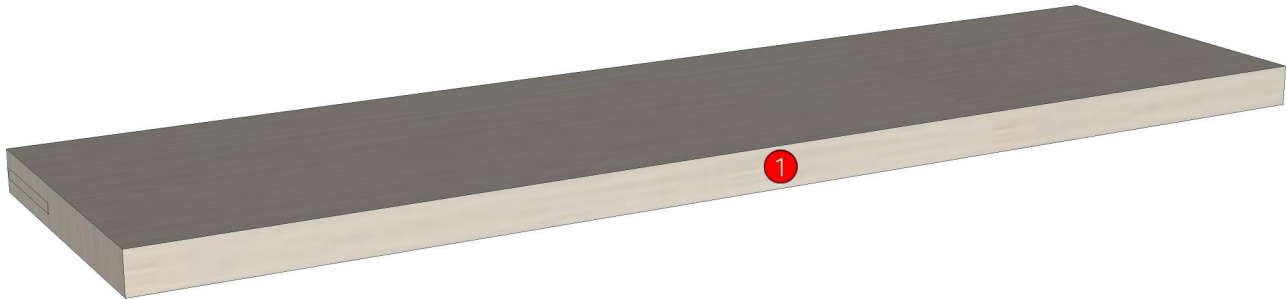

Model	LANDMARK_TSH_DSH1400		
Creator	PASATHORN	.BCP Name	INDEX_C3D_KITCHEN2
Reviewer		Order	I004089
Approves	<i>P. SAWAI</i>	Date	24/04/2025

No.	Article No.	Description	Mat	Dimension	Cutting Size	Typeology	Skin
0	LANDMARK_TSH_DSH1400	LANDMARK_TSH_DSH1400		1440x50x400			
	LANDMARK_TSH_DSH1400-01	SHELF Panel-SP	MDF-SP	48x400x1440	L2:W0	50000_STR=30.47_EDG=6826-1	2
	LANDMARK_TSH_DSH1400-01A	TOP BOT Panel-SP	MDF-SP	16x410x1450	16X410X1450;NO EDGE	182000_STR=30.47_EDG=-	1
	LANDMARK_TSH_DSH1400-01A	TOP BOT Panel-SP	MDF-SP	16x410x1450	16X410X1450;NO EDGE	182001_STR=30.47_EDG=-	1
	LANDMARK_TSH_DSH1400-01B	FRONT BACK BOTOM	MDFHMR-SP	16x80x1450	16X80X1450;NO EDGE	182002_STR=NOTXTE3_EDG=-	
	LANDMARK_TSH_DSH1400-01B	FRONT BACK BOTOM	MDFHMR-SP	16x80x1450	16X80X1450;NO EDGE	182003_STR=NOTXTE3_EDG=-	
	LANDMARK_TSH_DSH1400-01C	INSIDE BOTTOM	MDFHMR-SP	16x80x250	16X80X250;NO EDGE	185000_STR=NOTXTE3_EDG=-	
	LANDMARK_TSH_DSH1400-01C	INSIDE BOTTOM	MDFHMR-SP	16x80x250	16X80X250;NO EDGE	185001_STR=NOTXTE3_EDG=-	
	LANDMARK_TSH_DSH1400-01C	INSIDE BOTTOM	MDFHMR-SP	16x80x250	16X80X250;NO EDGE	185002_STR=NOTXTE3_EDG=-	
	LANDMARK_TSH_DSH1400-01C	INSIDE BOTTOM	MDFHMR-SP	16x80x250	16X80X250;NO EDGE	185003_STR=NOTXTE3_EDG=-	
	LANDMARK_TSH_DSH1400-01C	INSIDE BOTTOM	MDFHMR-SP	16x80x250	16X80X250;NO EDGE	185004_STR=NOTXTE3_EDG=-	
	LANDMARK_TSH_DSH1400-02	MAI LIM	MDF-SP	9x12x150	9X12X150;NO EDGE	184000_STR=NOTXTE3_EDG=-	
	LANDMARK_TSH_DSH1400-02	MAI LIM	MDF-SP	9x12x150	9X12X150;NO EDGE	184001_STR=NOTXTE3_EDG=-	