

Model	LIFE_CN_DB40LS		
Creator	PASATHORN	.BCP Name	INDEX_C3D_KITCHEN2
Reviewer		Order	I003919
Approves	P.SAWAI	Date	04/02/2025

LIFE_CN_DB40LS-400X570X913

Colour

05.38 ML MD692 (SS)_
05.30 ML WHITE SAND #VM1012/2610/2610(PEARL)_

Edge

01.286 1 MD692 _
01.47 1 WHITE _

K101L-160157188

R&D REVIEW	
<input checked="" type="checkbox"/>	DWG.Customer
<input checked="" type="checkbox"/>	Work Report
<input type="checkbox"/>	Function
<input type="checkbox"/>	สินค้าตรงตัวอย่าง
ผู้ทบทวน <u>P.SAWAI</u>	
<u>04/02/2025</u>	

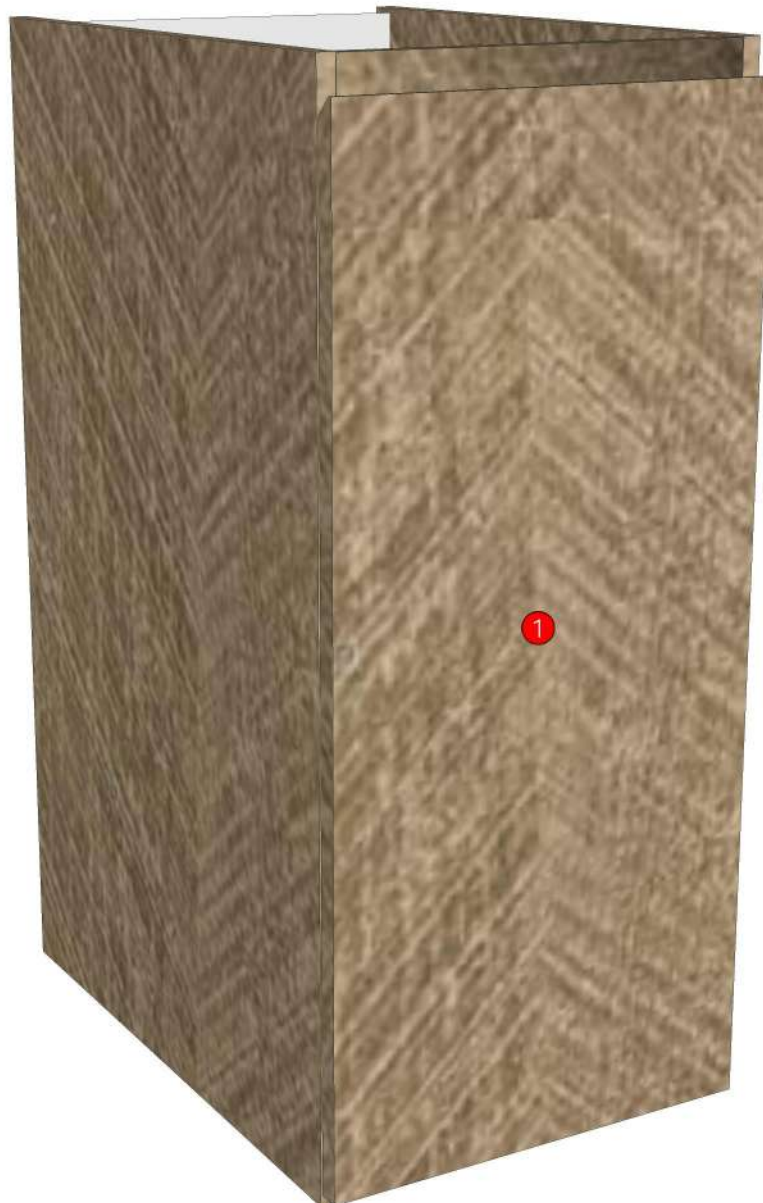

Model	-LIFE_CN_DB40LS		
Creator		.BCP Name	INDEX_C3D_KITCHEN2
Reviewer		Order	I003919
Approves	P.SAWAI	Date	

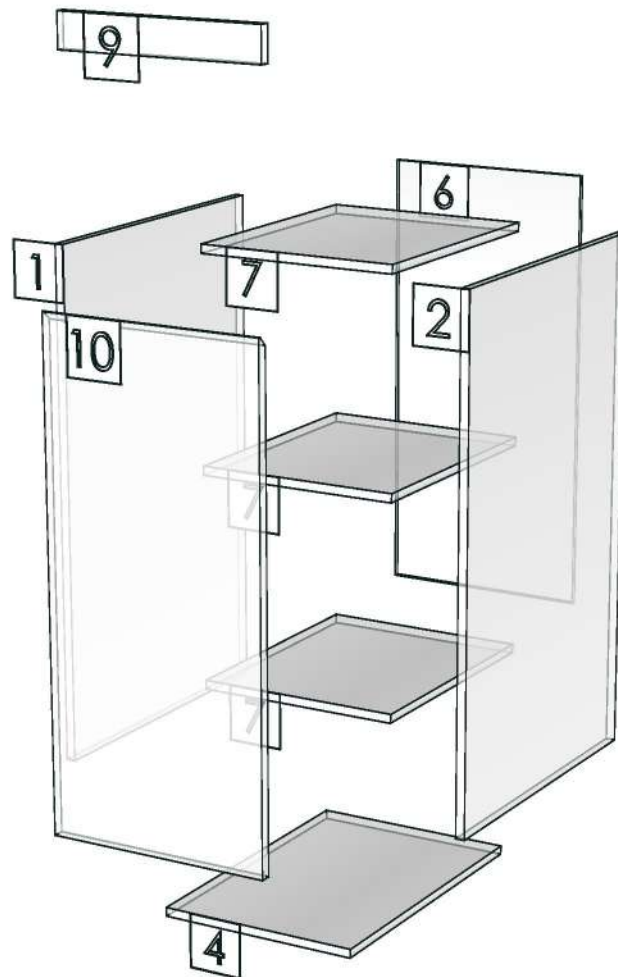

Model	LIFE_CN_DBO669R		
Creator	PASATHORN	.BCP Name	INDEX_C3D_KITCHEN2
Reviewer		Order	I003914
Approves	P.SAWAI	Date	04/02/2025

LIFE_CN_DBO669R-669X570X913

Colour

05.38 ML MD692 (SS)_

05.30 ML WHITE SAND #VM1012/2610/2610(PEARL)_

-

-

-

K101L-160157188

Edge

01.286 1 MD692 _

01.47 1 WHITE _

-

-

-

R&D REVIEW	
<input checked="" type="checkbox"/>	DWG.Customer
<input checked="" type="checkbox"/>	Work Report
<input type="checkbox"/>	Function
<input type="checkbox"/>	สินค้าตรงตัวอย่าง
ผู้ทบทวน <u>P.SAWAI</u>	
<u>04/02/2025</u>	

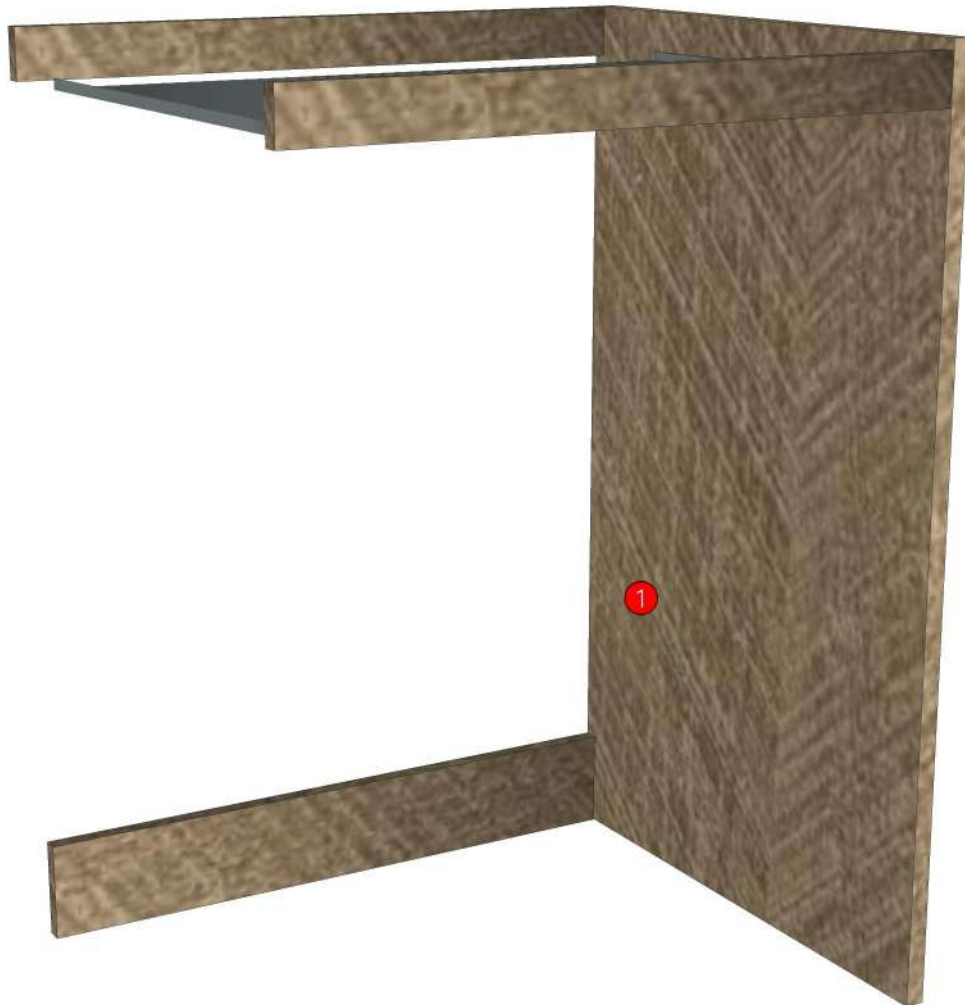

Model	-LIFE_CN_DBO669R		
Creator		.BCP Name	INDEX_C3D_KITCHEN2
Reviewer		Order	I003914
Approves	P.SAWAI	Date	

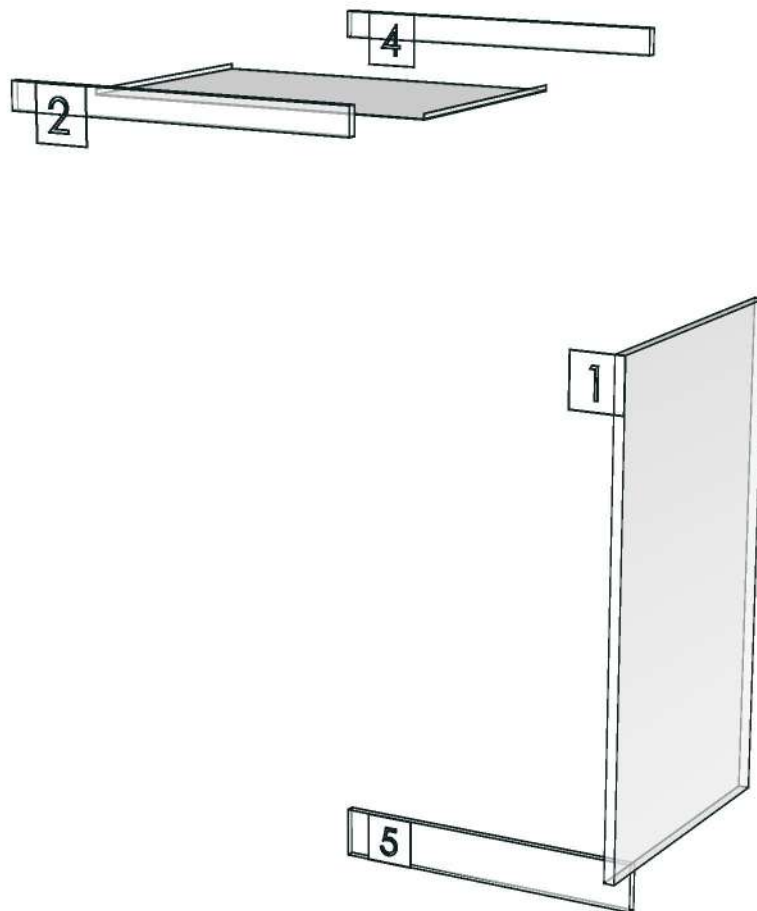

Model	LIFE_CN_DBS581LGR		
Creator	PASATHORN	.BCP Name	INDEX_C3D_KITCHEN2
Reviewer		Order	I003916
Approves	P.SAWAI	Date	04/02/2025

LIFE_CN_DBS581LGR-581X570X913

Colour

05.38 ML MD692 (SS)_
05.30 ML WHITE SAND #VM1012/2610/2610(PEARL)_

Edge

01.286 1 MD692 _

-
-
-

K101L-160157188

R&D REVIEW

- DWG.Customer
- Work Report
- Function
- สินค้าตรงตัวอย่าง

ผู้ทบทวน P.SAWAI

04/02/25



Model	-LIFE_CN_DBS581LGR		
Creator		.BCP Name	INDEX_C3D_KITCHEN2
Reviewer		Order	I003916
Approves	P.SAWAI	Date	

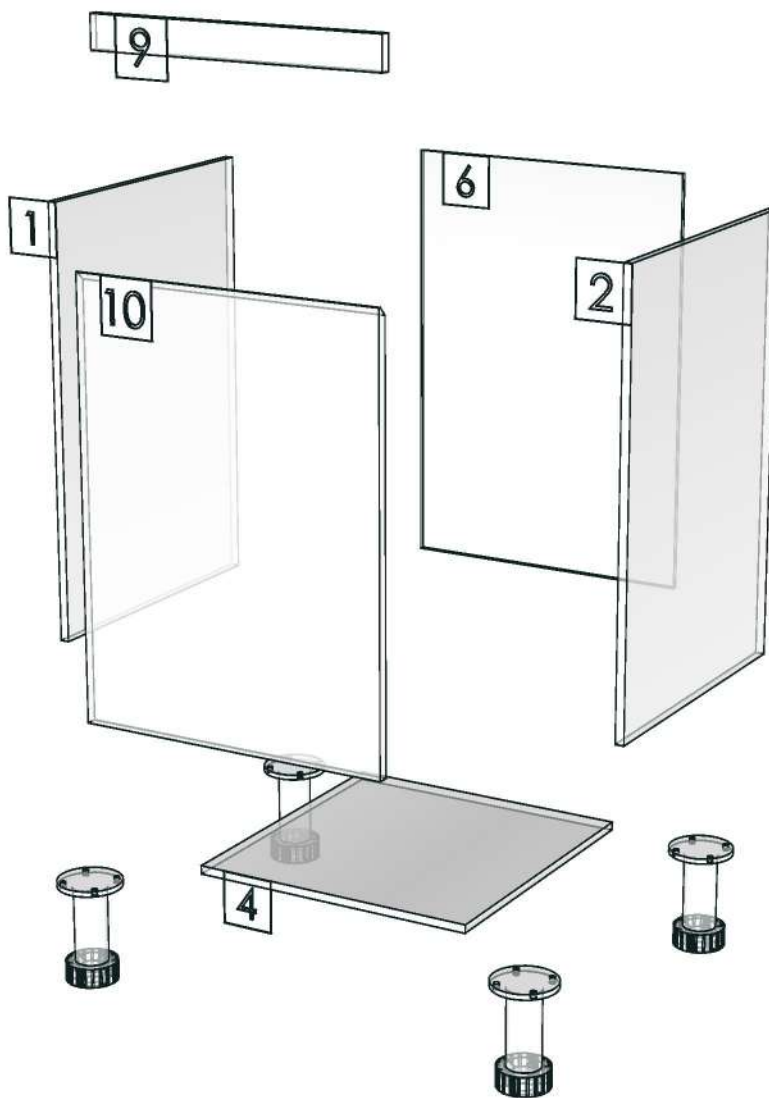

Model	LIFE_CN_DDM5009		
Creator	PASATHORN	.BCP Name	INDEX_C3D_KITCHEN2
Reviewer		Order	I003908
Approves	P.SAWAI	Date	31/01/2025

LIFE_CN_DDM5009-500X9X600

Colour

05.38 ML MD692 (SS)_

-
-
-
-

Edge

01.286 1 MD692 _

-
-
-
-

K101L-160157188

K101R-160166000

R&D REVIEW	
<input checked="" type="checkbox"/>	DWG.Customer
<input checked="" type="checkbox"/>	Work Report
<input type="checkbox"/>	Function
<input type="checkbox"/>	สินค้าตรงตัวอย่าง
ผู้ทบทวน <u>P.SAWAI</u>	
<u>31/01/25</u>	

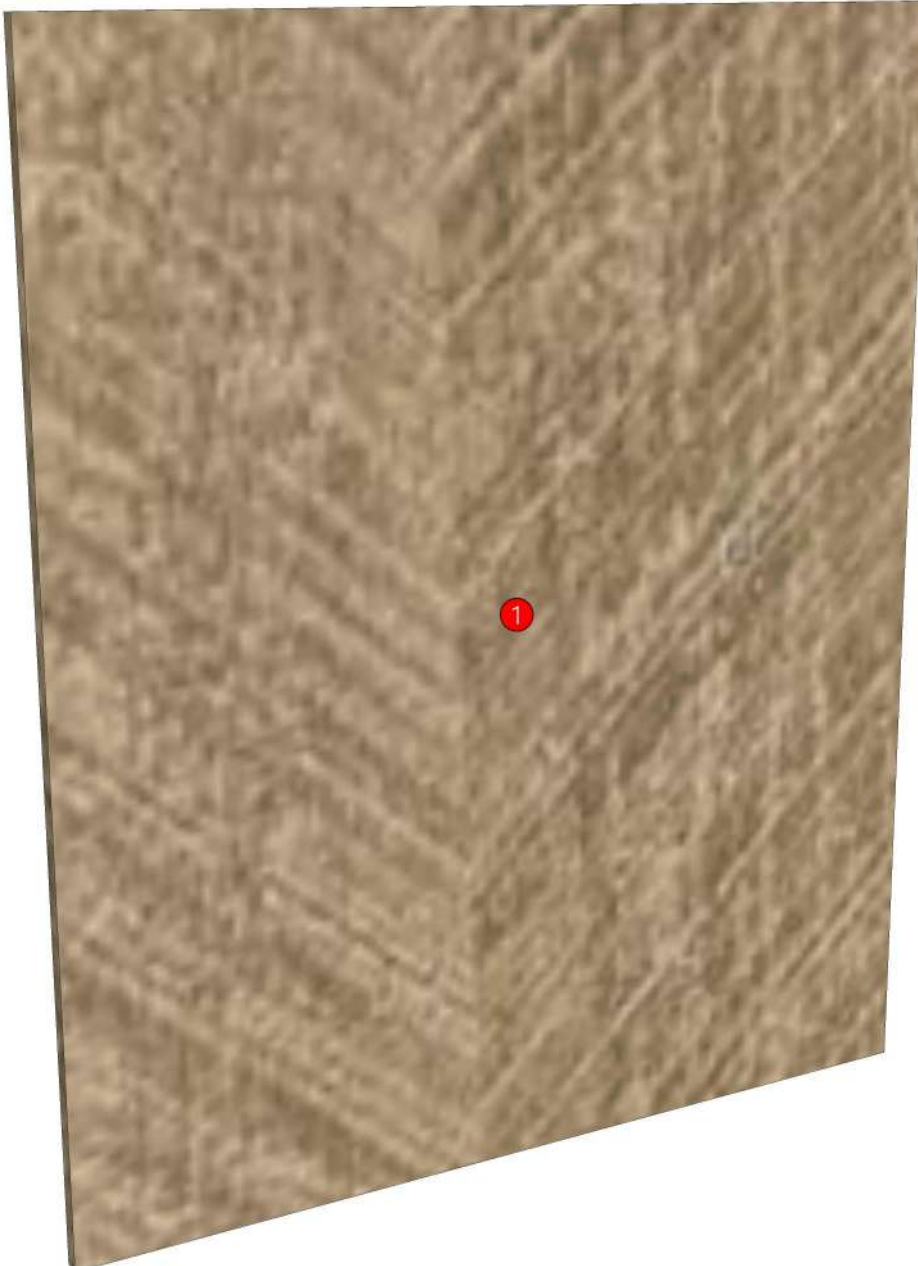

Model	LIFE_CN_DDM5009		
Creator	PASATHORN	.BCP Name	INDEX_C3D_KITCHEN2
Reviewer		Order	I003908
Approves	P.SAWAI	Date	31/01/2025

No.	Article No.	Description	Mat	Dimension	Cutting Size	Typepology	Skin
0	LIFE_CN_DDM5009	LIFE_CN_DDM5009		500x600x9			
	LIFE_CN_DDM5009-01	DDM	PB-SP	9x500x600	9X499X598;L1:W2	186000 _STR=05.38 _EDG=MD692-1	2

Model	LIFE_CN_DDM700		
Creator	PASATHORN	.BCP Name	INDEX_C3D_KITCHEN2
Reviewer		Order	I003907
Approves	P.SAWAI	Date	31/01/2025

LIFE_CN_DDM700-700X16X150

Colour

05.38 ML MD692 (SS)_

-
-
-
-

K101L-160157188

K101R-160166000

K103L-160157198

K104L-160136071

Edge

01.286 1 MD692 _

-
-
-
-

R&D REVIEW	
<input checked="" type="checkbox"/>	DWG.Customer
<input checked="" type="checkbox"/>	Work Report
<input type="checkbox"/>	Function
<input type="checkbox"/>	สินค้าตรงตัวอย่าง
ผู้ทบทวน <u>P.SAWAI</u>	
<u>31/01/25</u>	

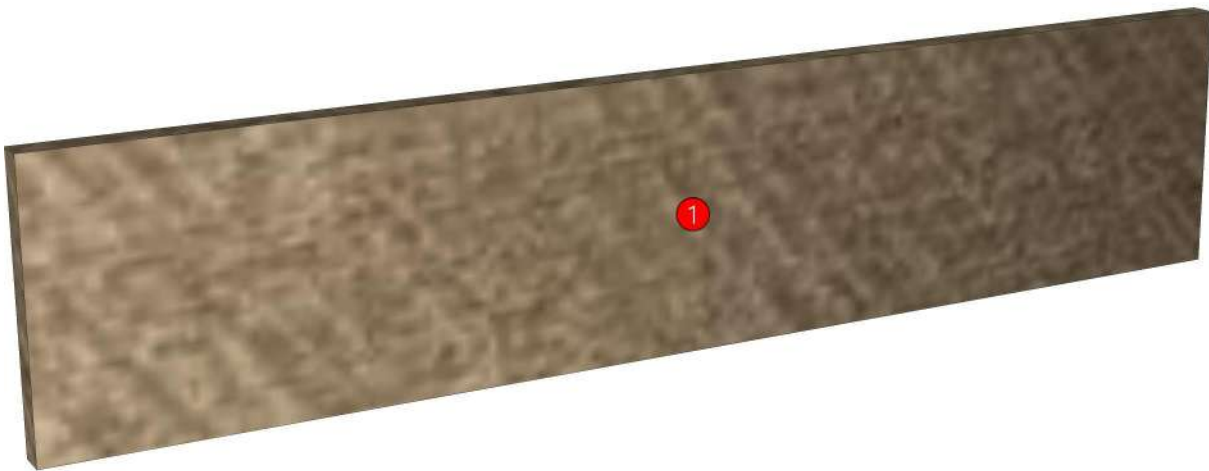

Model	LIFE_CN_DDM700		
Creator	PASATHORN	.BCP Name	INDEX_C3D_KITCHEN2
Reviewer		Order	I003907
Approves	P.SAWAI	Date	31/01/2025

No.	Article No.	Description	Mat	Dimension	Cutting Size	Typepology	Skin
0	LIFE_CN_DDM700 LIFE_CN_DDM700-01	LIFE_CN_DDM700 DDM-SP	PB-SP	700x150x16 16x150x700	16X148X699;L2:W1	183000 _STR=05.38 _EDG=MD692-1	2

Model	LIFE_CN_DFBS		
Creator	PASATHORN	.BCP Name	INDEX_C3D_KITCHEN2
Reviewer		Order	I003904
Approves	P.SAWAI	Date	31/01/2025

LIFE_CN_DFBS-150X16X913

Colour

05.38 ML MD692 (SS)_

-
-
-
-

K101L-160157188

K101R-160166000

Edge

01.286 1 MD692 _

-
-
-
-

R&D REVIEW	
<input checked="" type="checkbox"/>	DWG.Customer
<input checked="" type="checkbox"/>	Work Report
<input type="checkbox"/>	Function
<input type="checkbox"/>	สินค้าตรงตัวอย่าง
ผู้ทบทวน <u>P.SAWAI</u>	
<u>31/01/25</u>	



Model	LIFE_CN_DFBS		
Creator	PASATHORN	.BCP Name	INDEX_C3D_KITCHEN2
Reviewer		Order	I003904
Approves	P.SAWAI	Date	31/01/2025

No.	Article No.	Description	Mat	Dimension	Cutting Size	Typepology	Skin
0	LIFE_CN_DFBS LIFE_CN_DFBS-01	LIFE_CN_DFBS Front DF-SP	PB-SP	150x913x16 16x150x913	16X149X911;L1:W2	186000 _STR=05.38 _EDG=MD692-1	2

Model	LIFE_CN_DFL		
Creator	PASATHORN	.BCP Name	INDEX_C3D_KITCHEN2
Reviewer		Order	I003905
Approves	P.SAWAI	Date	31/01/2025

LIFE_CN_DFL-150X16X900

Colour

05.38 ML MD692 (SS)_

-
-
-
-

Edge

01.286 1 MD692 _

-
-
-
-

K101L-160157188

K101R-160166000

K103L-160157198

K104L-160136071

R&D REVIEW	
<input checked="" type="checkbox"/>	DWG.Customer
<input checked="" type="checkbox"/>	Work Report
<input type="checkbox"/>	Function
<input type="checkbox"/>	สินค้าตรงตัวอย่าง
ผู้ทบทวน <u>P.SAWAI</u>	
<u>31/01/25</u>	

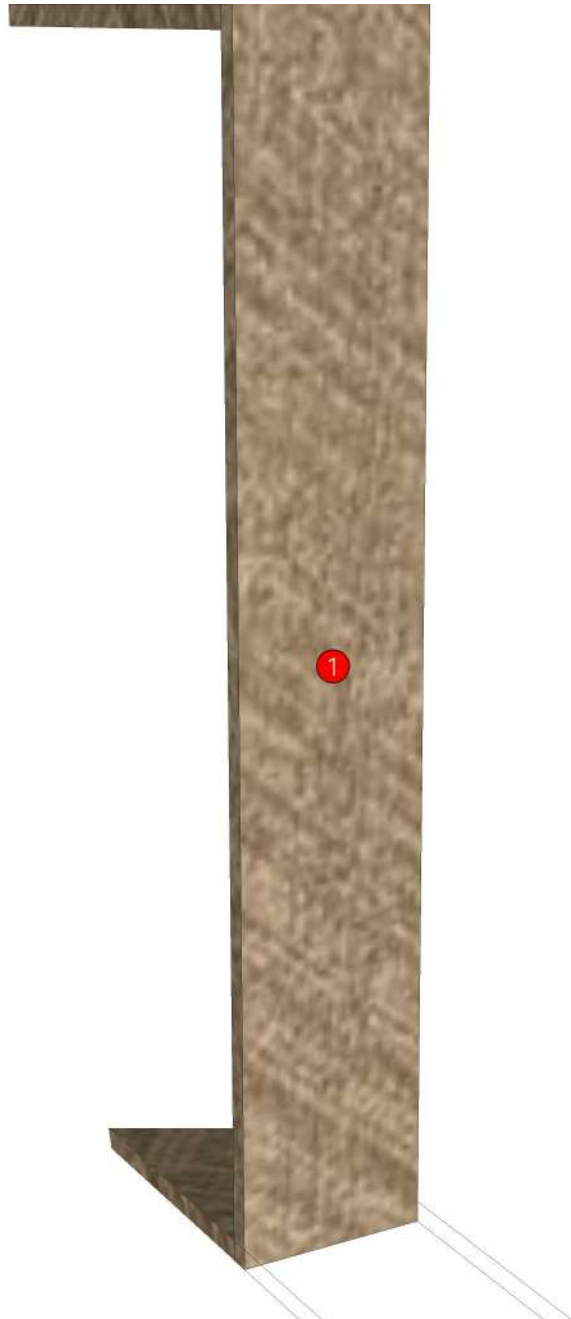

Model	-LIFE_CN_DFL		
Creator		.BCP Name	INDEX_C3D_KITCHEN2
Reviewer		Order	I003905
Approves	P.SAWAI	Date	

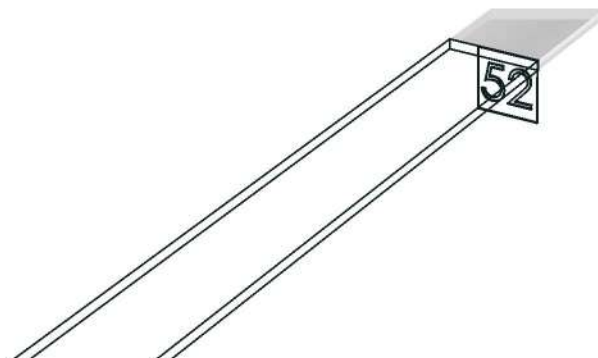

Model	LIFE_CN_DF_CL1800		
Creator	PASATHORN	.BCP Name	INDEX_C3D_KITCHEN2
Reviewer		Order	I003901
Approves	P.SAWAI	Date	31/01/2025

LIFE_CN_DF_CL1800-1800X16X155

Colour

05.38 ML MD692 (SS)_

-
-
-
-

Edge

01.286 1 MD692 _

-
-
-
-

K101L-160157188

K101R-160166000

R&D REVIEW	
<input checked="" type="checkbox"/>	DWG.Customer
<input checked="" type="checkbox"/>	Work Report
<input type="checkbox"/>	Function
<input type="checkbox"/>	สินค้าตรงตัวอย่าง
ผู้ทบทวน <u>P.SAWAI</u>	
<u>31/01/25</u>	



Model	LIFE_CN_DF_CL1800		
Creator	PASATHORN	.BCP Name	INDEX_C3D_KITCHEN2
Reviewer		Order	I003901
Approves	P.SAWAI	Date	31/01/2025

No.	Article No.	Description	Mat	Dimension	Cutting Size	Typepology	Skin
0	LIFE_CN_DF_CL1800	LIFE_CN_DF_CL1800		1800x155x16			
	LIFE_CN_DF_CL1800-01	DF_CL-SP	PB-SP	16x155x1800	16X154X1800;L1:W0	183000_STR=05.38_EDG=MD692-1	2

Model	LIFE_CN_DL40L		
Creator	PASATHORN	.BCP Name	INDEX_C3D_KITCHEN2
Reviewer		Order	I003909
Approves	P.SAWAI	Date	03/02/2025

LIFE_CN_DL40L-400X350X900

Colour

05.38 ML MD692 (SS)_

05.30 ML WHITE SAND #VM1012/2610/2610(PEARL)_

-

-

-

K101L-160157188

Edge

01.286 1 MD692 _

01.47 1 WHITE _

-

-

-

R&D REVIEW	
<input checked="" type="checkbox"/>	DWG.Customer
<input checked="" type="checkbox"/>	Work Report
<input type="checkbox"/>	Function
<input type="checkbox"/>	สินค้าตรงตัวอย่าง
ผู้ทบทวน <u>P.SAWAI</u>	
<u>03/02/2025</u>	

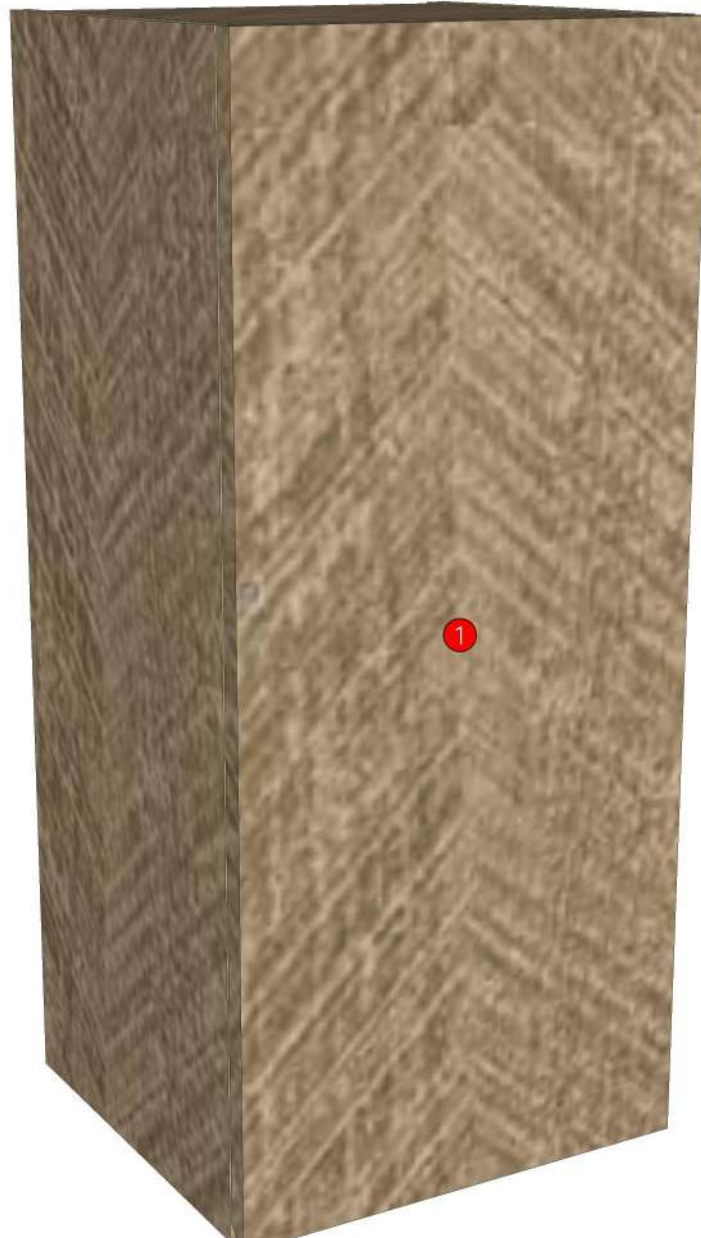

Model	-LIFE_CN_DL40L		
Creator		.BCP Name	INDEX_C3D_KITCHEN2
Reviewer		Order	I003909
Approves	P.SAWAI	Date	

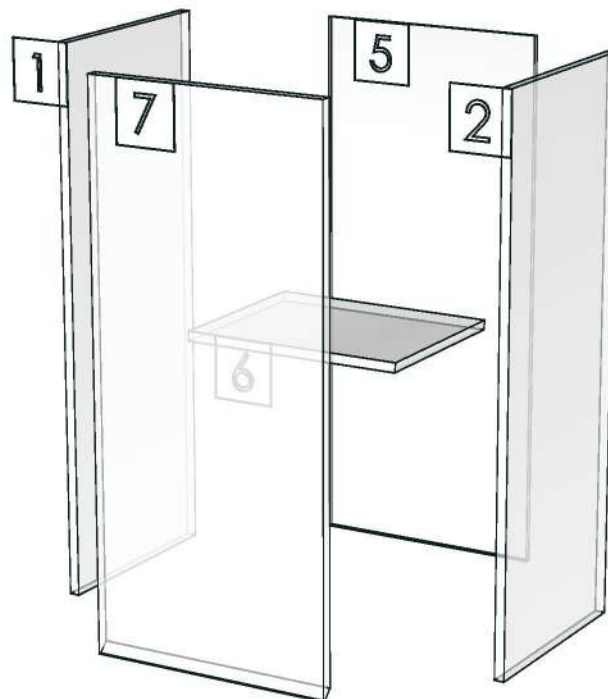

Model	LIFE_CN_DL60HR		
Creator	PASATHORN	.BCP Name	INDEX_C3D_KITCHEN2
Reviewer		Order	I003923
Approves	P.SAWAI	Date	05/02/2025

LIFE_CN_DL60HR-600X350X860

Colour

05.38 ML MD692 (SS)_
05.30 ML WHITE SAND #VM1012/2610/2610(PEARL)_

Edge

01.286 1 MD692 _
01.47 1 WHITE _

R&D REVIEW

- DWG.Customer
- Work Report
- Function
- สินค้าตรงตัวอย่าง

ผู้ทบทวน P.SAWAI
05/02/2025

K101L-160157188

K103L-160157198

K104L-160136071



Model	-LIFE_CN_DL60HR		
Creator		.BCP Name	INDEX_C3D_KITCHEN2
Reviewer		Order	I003923
Approves	P.SAWAI	Date	

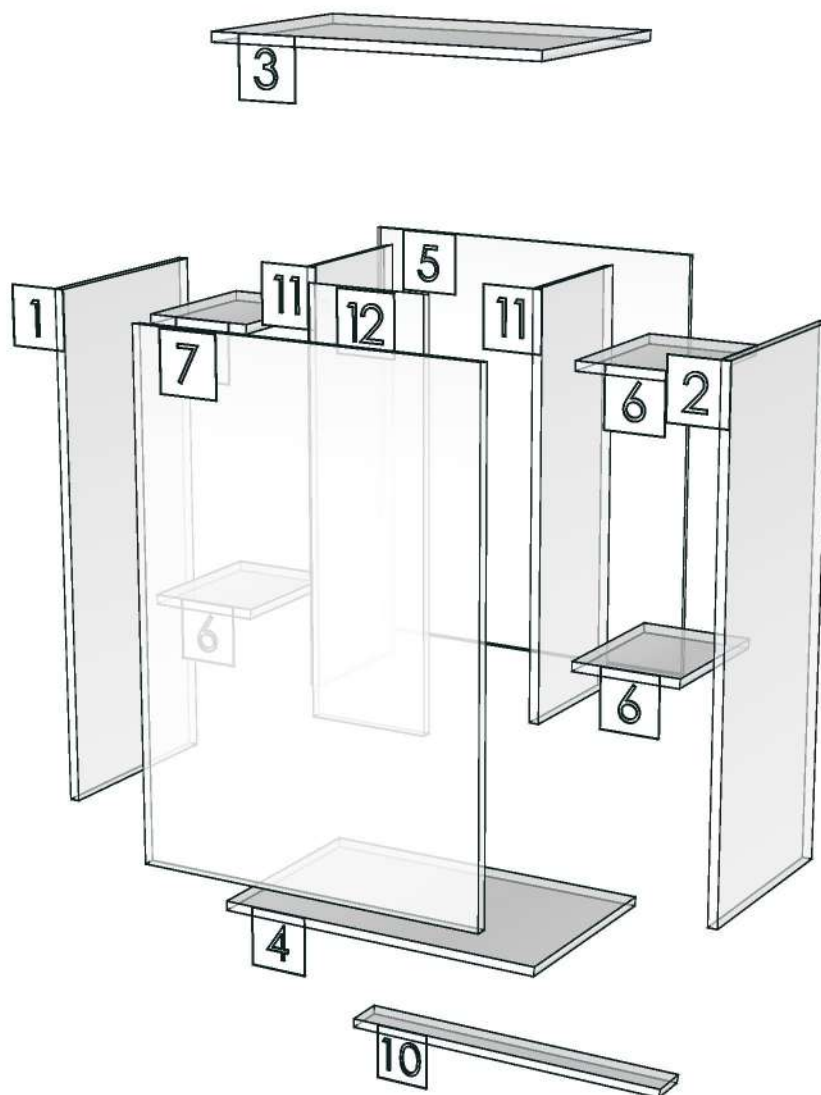

Model	LIFE_CN_DLMV60L		
Creator	PASATHORN	.BCP Name	INDEX_C3D_KITCHEN2
Reviewer		Order	I003910
Approves	P.SAWAI	Date	03/02/2025

LIFE_CN_DLMV60L-600X400X1050

Colour

05.38 ML MD692 (SS)_

05.30 ML WHITE SAND #VM1012/2610/2610(PEARL)_

-

-

-

K101L-160157188

Edge

01.286 1 MD692 _

01.47 1 WHITE _

-

-

-

R&D REVIEW	
<input checked="" type="checkbox"/>	DWG.Customer
<input checked="" type="checkbox"/>	Work Report
<input type="checkbox"/>	Function
<input type="checkbox"/>	สินค้าตรงตัวอย่าง
ผู้ทบทวน <u>P.SAWAI</u>	
<u>03/02/2025</u>	

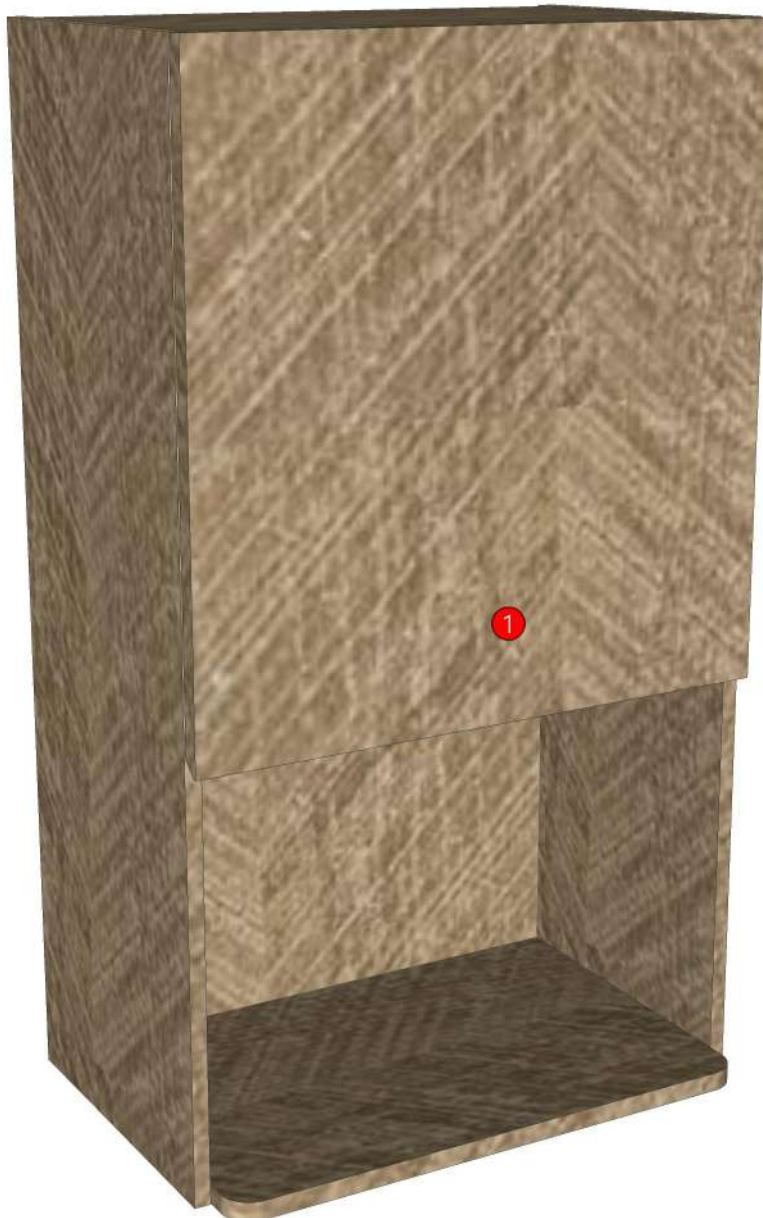

Model	-LIFE_CN_DLMV60L		
Creator		.BCP Name	INDEX_C3D_KITCHEN2
Reviewer		Order	I003910
Approves	P.SAWAI	Date	

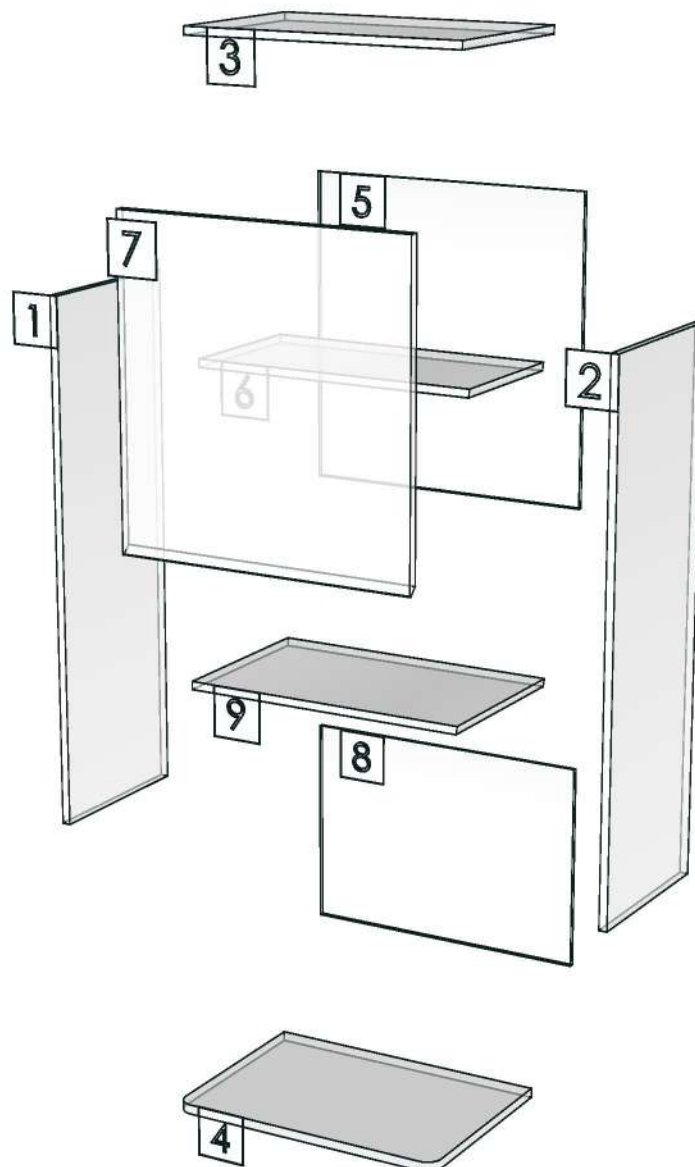

Model	LIFE_CN_D_PLT581		
Creator	PASATHORN	.BCP Name	INDEX_C3D_KITCHEN2
Reviewer		Order	I003894
Approves	P.SAWAI	Date	30/01/2025

LIFE_CN_D_PLT581-581X9X100

Colour

05.38 ML MD692 (SS)_

-
-
-
-

Edge

01.286 1 MD692 _

-
-
-
-

K101L-160157188

K101R-160166000

R&D REVIEW	
<input checked="" type="checkbox"/>	DWG.Customer
<input checked="" type="checkbox"/>	Work Report
<input type="checkbox"/>	Function
<input type="checkbox"/>	สินค้าตรงตัวอย่าง
ผู้ทบทวน <u>P.SAWAI</u>	
<u>30/01/25</u>	

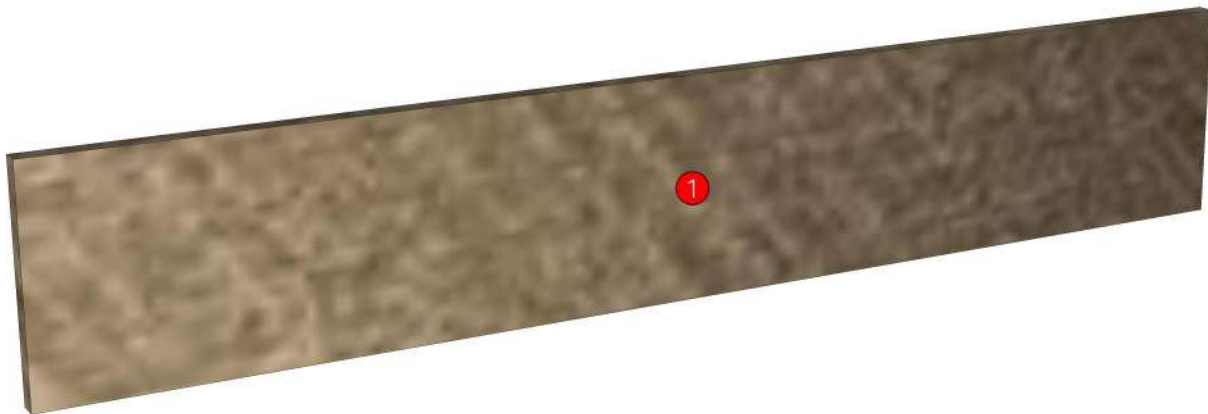

Model	LIFE_CN_D_PLT581		
Creator	PASATHORN	.BCP Name	INDEX_C3D_KITCHEN2
Reviewer		Order	I003894
Approves	P.SAWAI	Date	30/01/2025

No.	Article No.	Description	Mat	Dimension	Cutting Size	Typepology	Skin
0	LIFE_CN_D_PLT581	LIFE_CN_D_PLT581		581x100x9			
	LIFE_CN_D_PLT581-01	D_PLINT-SP	PB-SP	9x100x581	9X98X579;L2:W2	183000 _STR=05.38 _EDG=MD692-1	2

Model	LIFE_CN_D_PLT600		
Creator	PASATHORN	.BCP Name	INDEX_C3D_KITCHEN2
Reviewer		Order	I003895
Approves	P.SAWAI	Date	31/01/2025

LIFE_CN_D_PLT600-600X9X100

Colour

05.38 ML MD692 (SS)_

-

-

-

K100L-160165993

K100R-160157181

K101L-160157188

K101R-160166000

K102L-160166010

K102R-160166018

K103L-160157198

K104L-160136071

K105L-160136079

Edge

01.286 1 MD692 _

-

-

-

-

R&D REVIEW	
<input checked="" type="checkbox"/>	DWG.Customer
<input checked="" type="checkbox"/>	Work Report
<input type="checkbox"/>	Function
<input type="checkbox"/>	สินค้าตรงตัวอย่าง
ผู้ทบทวน <u>P.SAWAI</u>	
<u>31/01/25</u>	

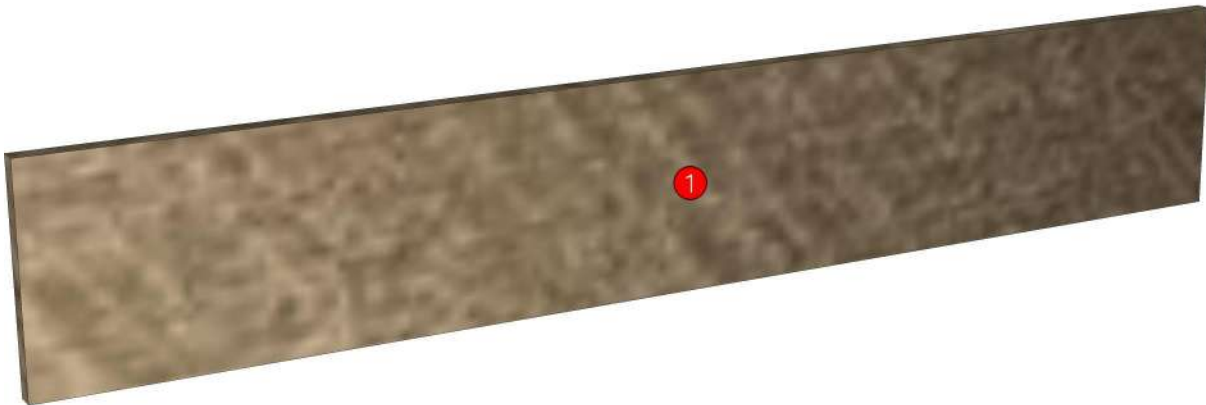

Model	LIFE_CN_D_PLT600		
Creator	PASATHORN	.BCP Name	INDEX_C3D_KITCHEN2
Reviewer		Order	I003895
Approves	P.SAWAI	Date	31/01/2025

No.	Article No.	Description	Mat	Dimension	Cutting Size	Typepology	Skin
0	LIFE_CN_D_PLT600	LIFE_CN_D_PLT600		600x100x9			
	LIFE_CN_D_PLT600-01	D_PLINT-SP	PB-SP	9x100x600	9X98X598;L2:W2	183000 _STR=05.38 _EDG=MD692-1	2