

<b>Model</b>	QUINTARA_TOP_K13R		
<b>Creator</b>	CHALEAMPHON	<b>.BCP Name</b>	INDEX_C3D_KITCHEN2
<b>Reviewer</b>		<b>Order</b>	H001646
<b>Approves</b>		<b>Date</b>	10/04/2025

## **QUINTARA\_TOP\_K13R-3700X2400X18**

**Colour**

04.74=LAMINATE HPL CARBON TERRAZZO 8303SL PF (4X8 ??? 0.

NOTXTE3=NO TEXTURE HMR

30.32=LAMINATE HPL NO.#1097-UN (4'X8' ??? 0.8 MM.)

**Edge**

04.01=0.8 HPL



K13R-160156520

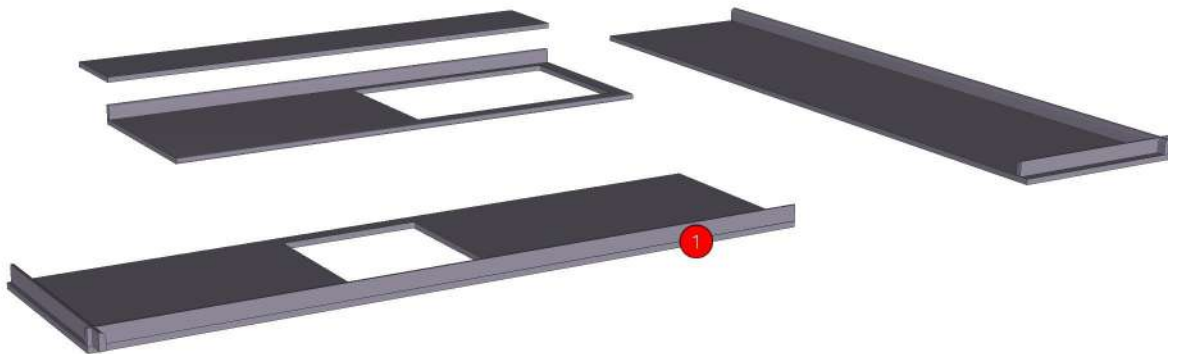

<b>Model</b>	-QUINTARA		
<b>Creator</b>	CHALEAMPON	<b>.BCP Name</b>	INDEX_C3D_KITCHEN2
<b>Reviewer</b>		<b>Order</b>	H001646
<b>Approves</b>		<b>Date</b>	10/04/2025

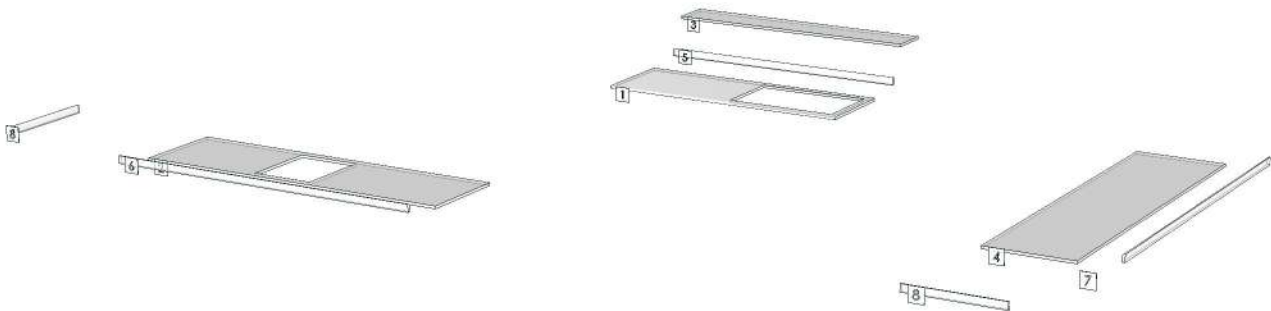

<b>Model</b>	QUINTARA_DB167R		
<b>Creator</b>	CHALEAMPHON	<b>.BCP Name</b>	INDEX_C3D_KITCHEN2
<b>Reviewer</b>		<b>Order</b>	H001531
<b>Approves</b>		<b>Date</b>	18/02/2025

## **QUINTARA\_DB167R-1670X580X910**

**Colour**

05.86=ML.EARTH TISSUE AX6 (TEXTILE)

30.25=ML.HMR WHITE # AE9V (MATT) (WET PROTECT)

**Edge**

01.408=1 AX6



K13R-160156520

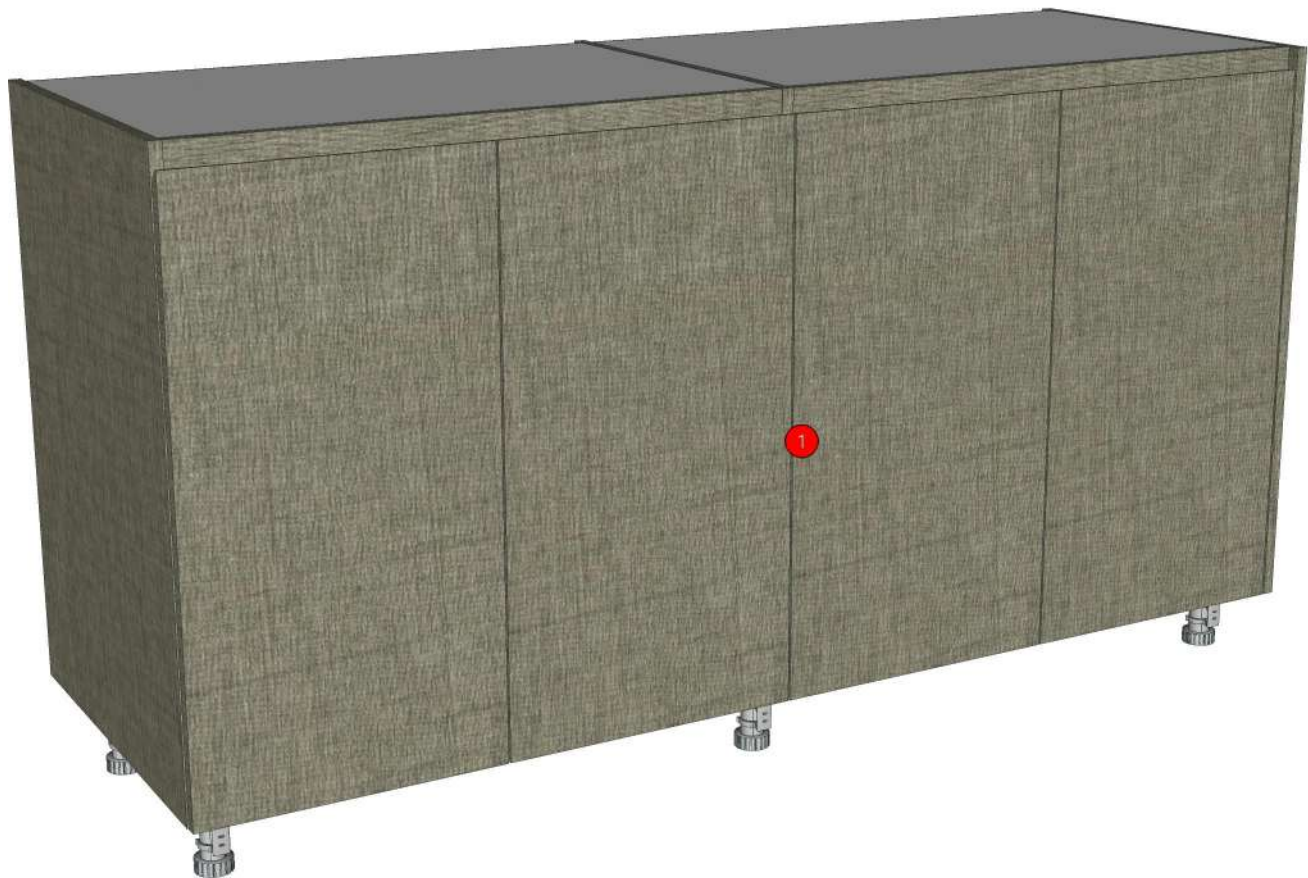

<b>Model</b>	-QUINTARA		
<b>Creator</b>	CHALEAMPHON	<b>.BCP Name</b>	INDEX_C3D_KITCHEN2
<b>Reviewer</b>		<b>Order</b>	H001531
<b>Approves</b>		<b>Date</b>	18/02/2025

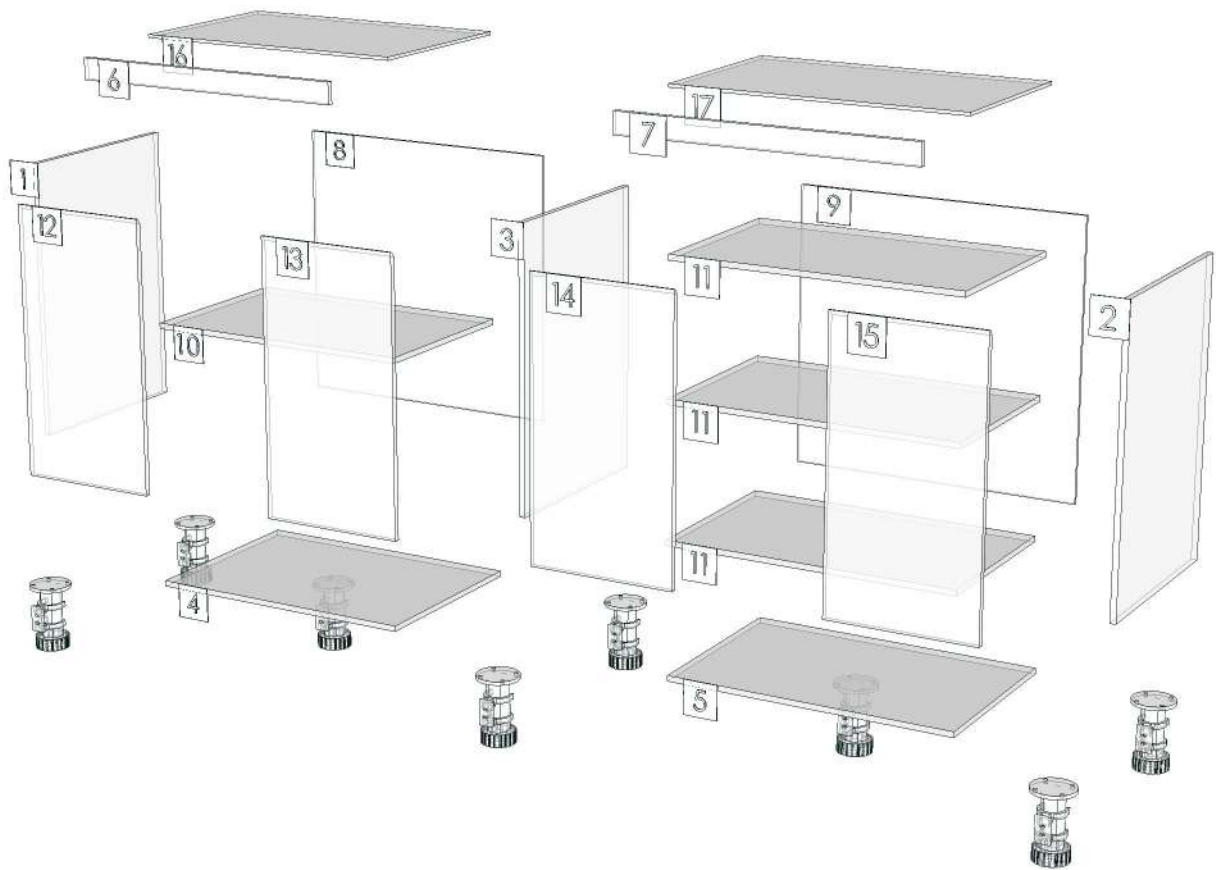

<b>Model</b>	QUINTARA_DB173R		
<b>Creator</b>	CHALEAMPHON	<b>.BCP Name</b>	INDEX_C3D_KITCHEN2
<b>Reviewer</b>		<b>Order</b>	H001532
<b>Approves</b>		<b>Date</b>	18/02/2025

## **QUINTARA\_DB173R-1730X580X910**

**Colour**

05.86=ML.EARTH TISSUE AX6 (TEXTILE)

30.25=ML.HMR WHITE # AE9V (MATT) (WET PROTECT)

**Edge**

01.408=1 AX6



K13R-160156520

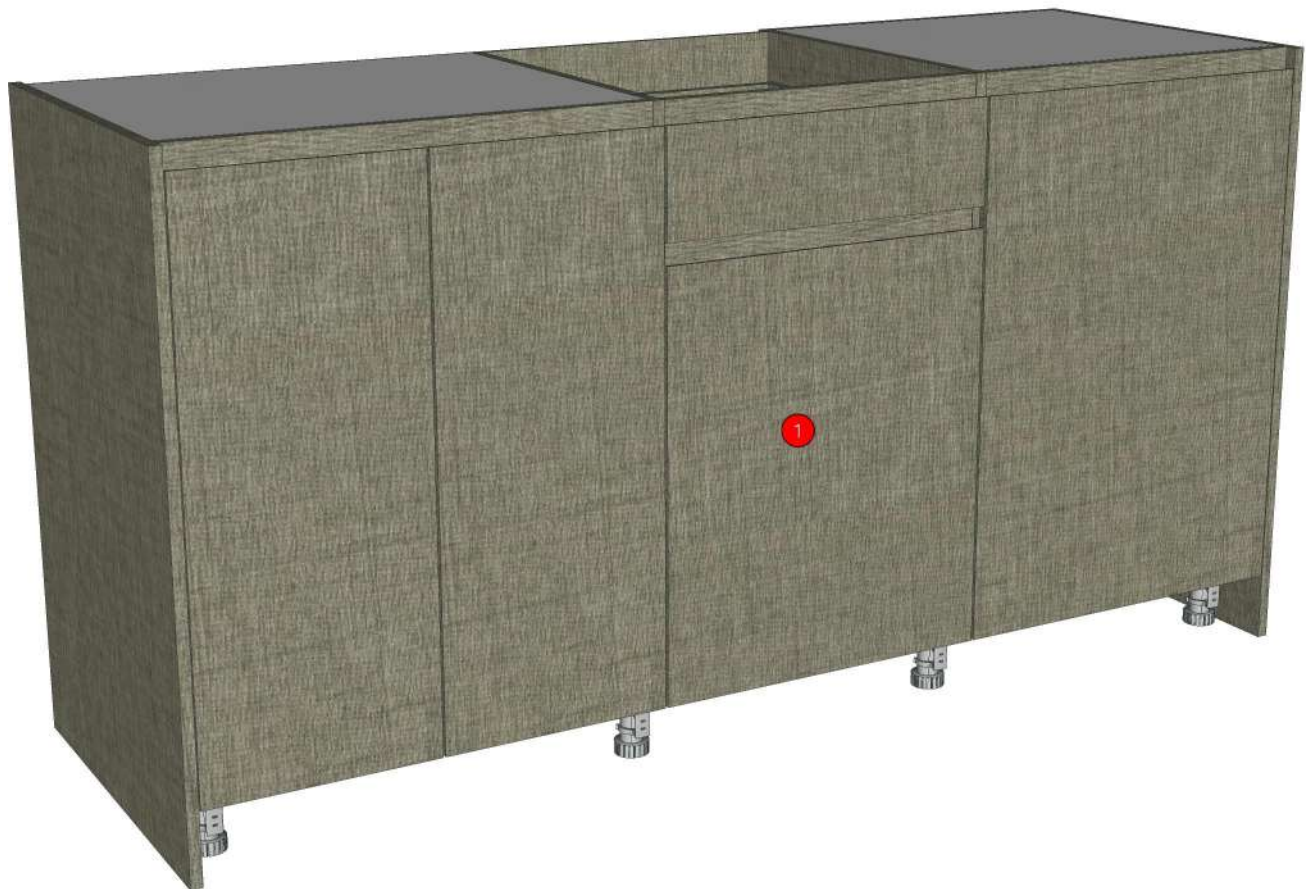

<b>Model</b>	-QUINTARA		
<b>Creator</b>	CHALEAMPHON	<b>.BCP Name</b>	INDEX_C3D_KITCHEN2
<b>Reviewer</b>		<b>Order</b>	H001532
<b>Approves</b>		<b>Date</b>	18/02/2025

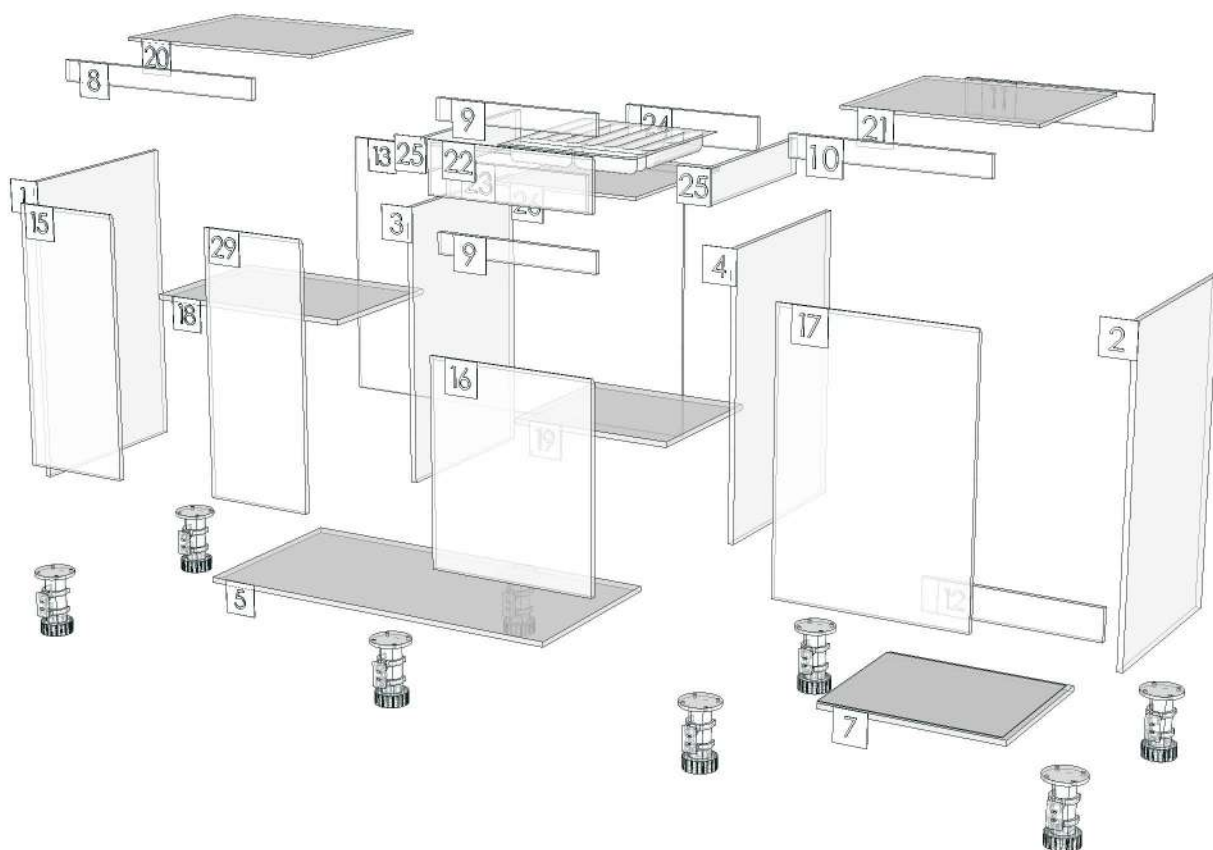



<b>Model</b>	-QUINTARA		
<b>Creator</b>	CHALEAMPHON	<b>.BCP Name</b>	INDEX_C3D_KITCHEN2
<b>Reviewer</b>		<b>Order</b>	H001533
<b>Approves</b>		<b>Date</b>	18/02/2025

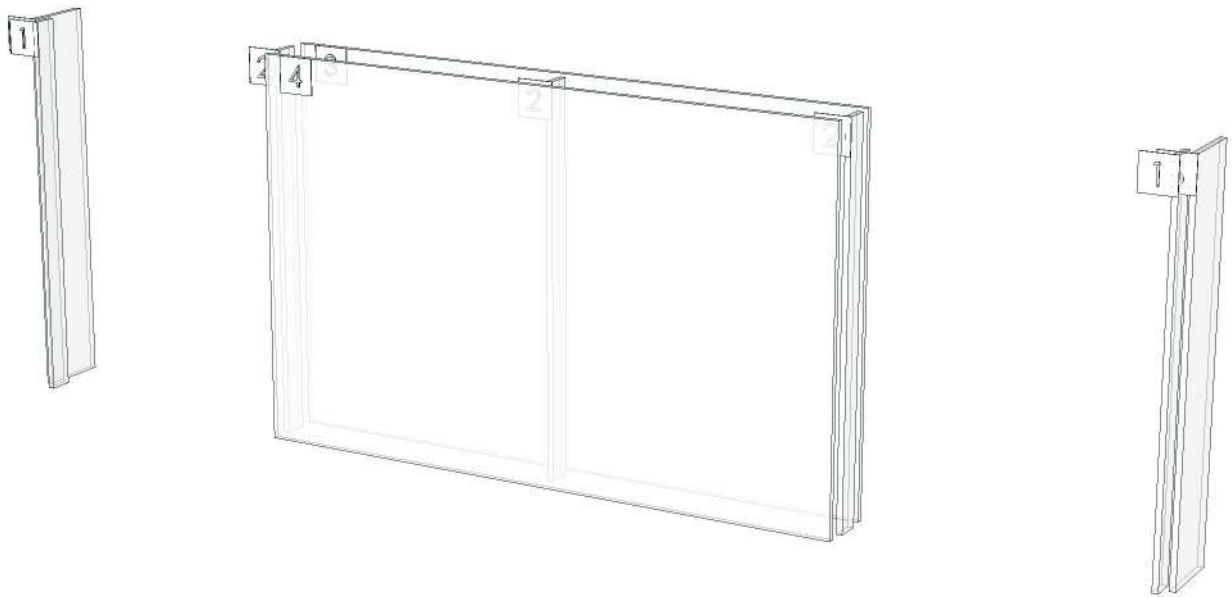

<b>Model</b>	QUINTARA_DB210R		
<b>Creator</b>	CHALEAMPHON	<b>.BCP Name</b>	INDEX_C3D_KITCHEN2
<b>Reviewer</b>		<b>Order</b>	H001534
<b>Approves</b>		<b>Date</b>	18/02/2025

## **QUINTARA\_DB210R-2100X580X910**

**Colour**

05.86=ML.EARTH TISSUE AX6 (TEXTILE)

30.25=ML.HMR WHITE # AE9V (MATT) (WET PROTECT)

**Edge**

01.408=1 AX6



K13R-160156520

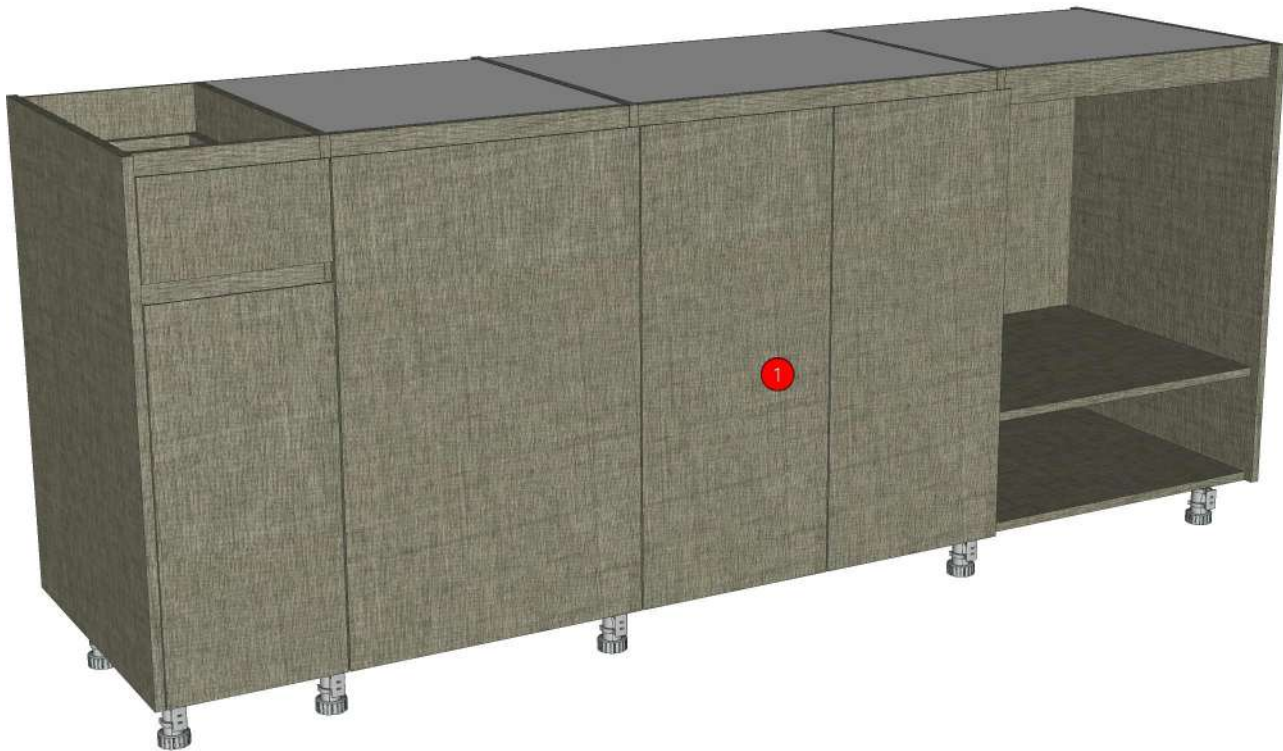

<b>Model</b>	-QUINTARA		
<b>Creator</b>	CHALEAMPHON	<b>.BCP Name</b>	INDEX_C3D_KITCHEN2
<b>Reviewer</b>		<b>Order</b>	H001534
<b>Approves</b>		<b>Date</b>	18/02/2025

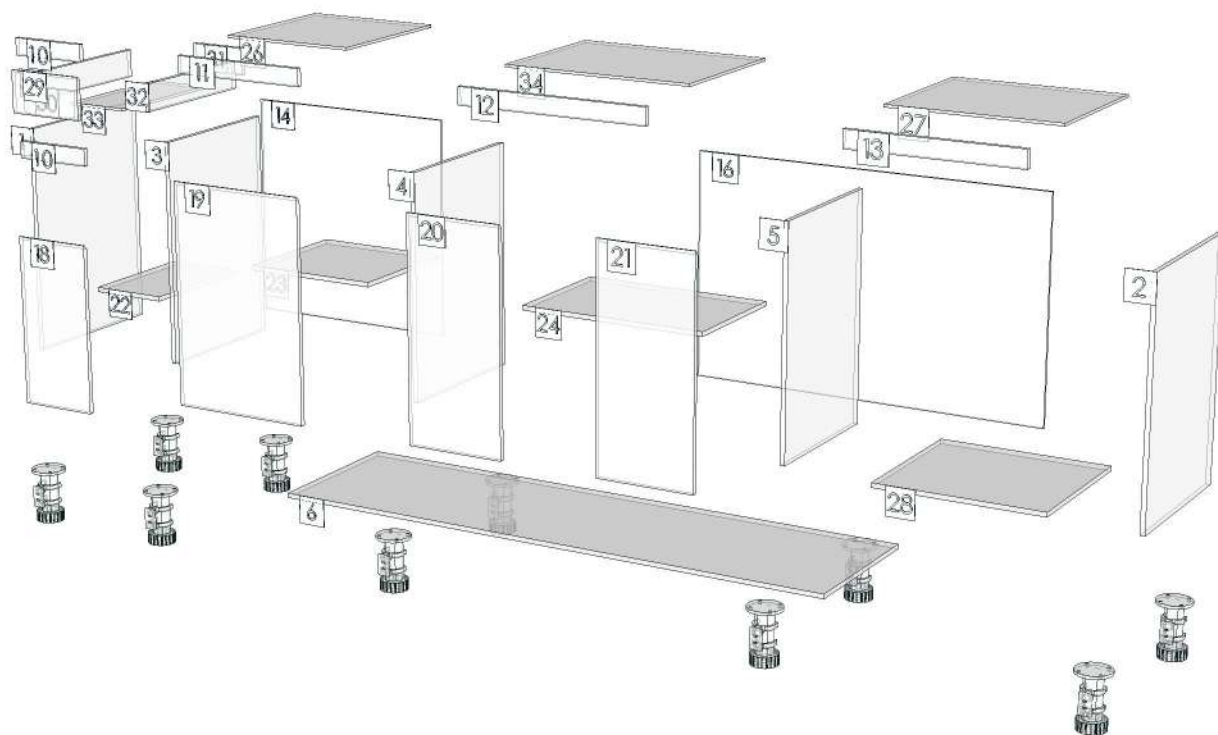

<b>Model</b>	QUINTARA_DBO666L		
<b>Creator</b>	CHALEAMPHON	<b>.BCP Name</b>	INDEX_C3D_KITCHEN2
<b>Reviewer</b>		<b>Order</b>	H000830
<b>Approves</b>		<b>Date</b>	08/02/2024

## QUINTARA\_DBO666L-666X580X910

### Colour

05.86=ML.EARTH TISSUE AX6 (TEXTILE)

30.25=ML.HMR WHITE # AE9V (MATT) (WET PROTECT)

### Edge

01.408=1 AX6



- K1R-160140987
- K8R-160134928
- K15R-160141023
- K2R-160156447
- K4R-160156463
- K5R-160156471
- K13R-160156520
- K21R-160156551
- K22L-1601

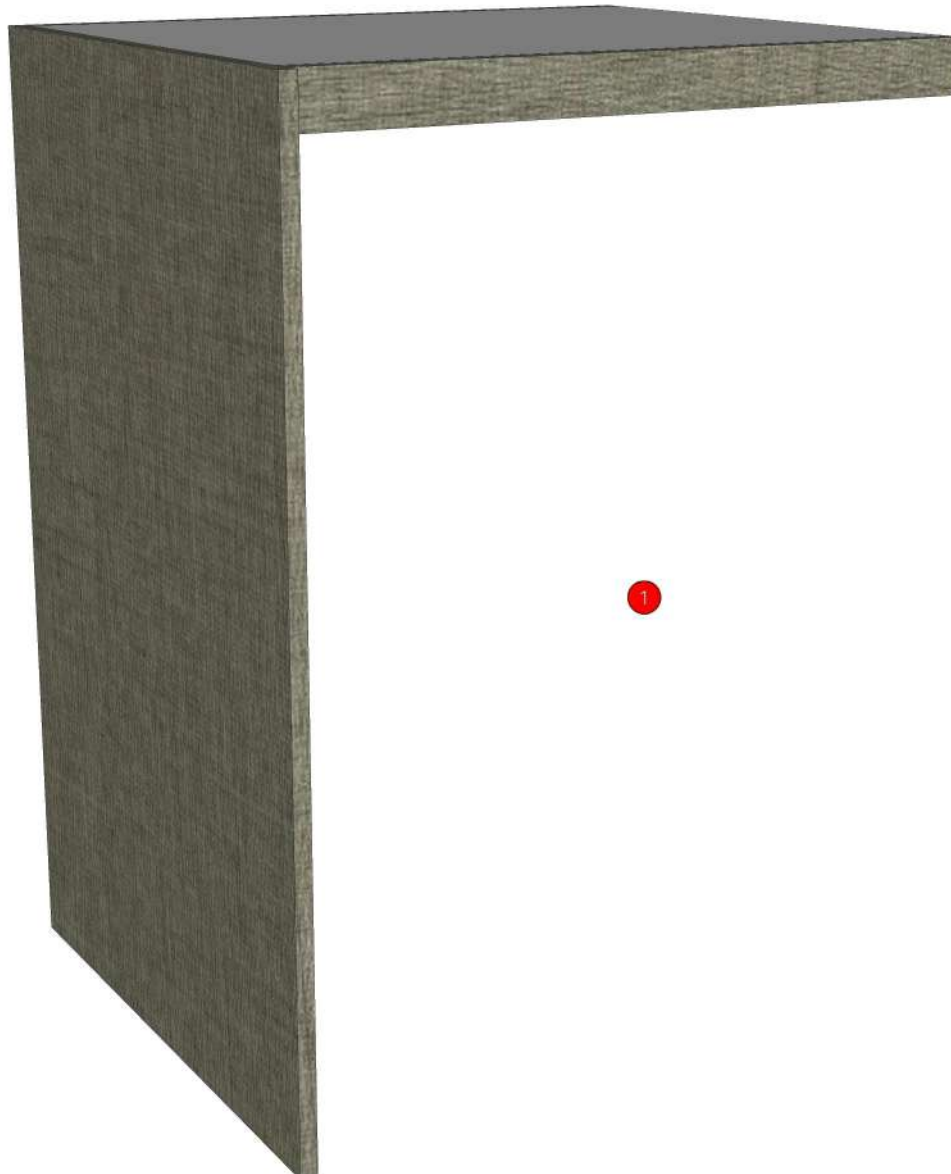

<b>Model</b>	-QUINTARA		
<b>Creator</b>	CHALEAMPHON	<b>.BCP Name</b>	INDEX_C3D_KITCHEN2
<b>Reviewer</b>		<b>Order</b>	H000830
<b>Approves</b>		<b>Date</b>	08/02/2024

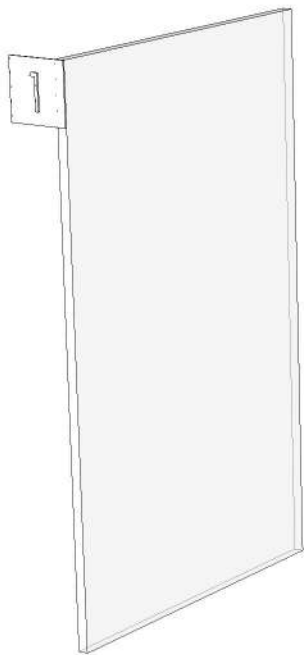
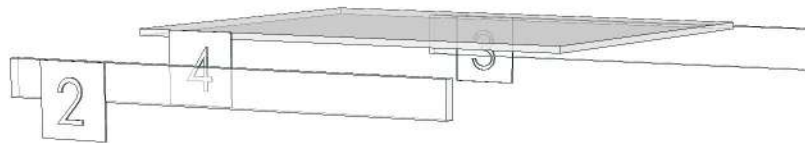

<b>Model</b>	QUINTARA_DDM_868		
<b>Creator</b>	CHALEAMPON	<b>.BCP Name</b>	INDEX_C3D_KITCHEN2
<b>Reviewer</b>		<b>Order</b>	H001559
<b>Approves</b>		<b>Date</b>	27/02/2025

## **QUINTARA\_DDM\_868-868X16X350**

**Colour**

05.86=ML.EARTH TISSUE AX6 (TEXTILE)

**Edge**

01.408=1 AX6



K13R-160156520

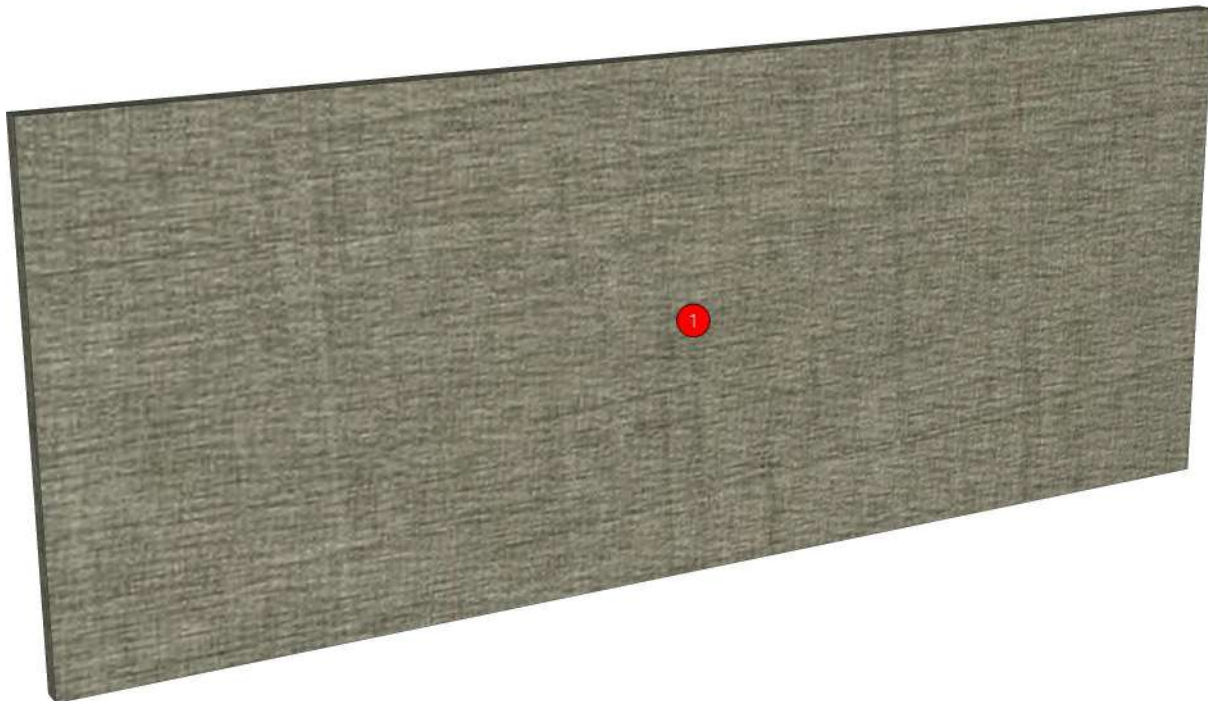

<b>Model</b>	-QUINTARA		
<b>Creator</b>	CHALEAMPON	<b>.BCP Name</b>	INDEX_C3D_KITCHEN2
<b>Reviewer</b>		<b>Order</b>	H001559
<b>Approves</b>		<b>Date</b>	27/02/2025

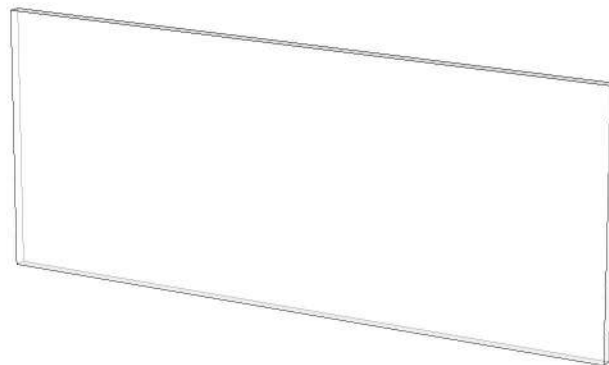

<b>Model</b>	QUINTARA_DFB		
<b>Creator</b>	CHALEAMPON	<b>.BCP Name</b>	INDEX_C3D_KITCHEN2
<b>Reviewer</b>		<b>Order</b>	H000842
<b>Approves</b>		<b>Date</b>	17/02/2024

## QUINTARA\_DFB-150X580X810

**Colour**

05.86=ML.EARTH TISSUE AX6 (TEXTILE)

**Edge**

01.408=1 AX6



- K3L-160140996
- K6R-160141005
- K8R-160134928
- K9L-160148447
- K10R-160148433
- K14L-160141014
- K14R-160134940
- K7L-160156480
- K11R-160156489
- K12R-160156505
- K13R-160156520
- K22L-1601

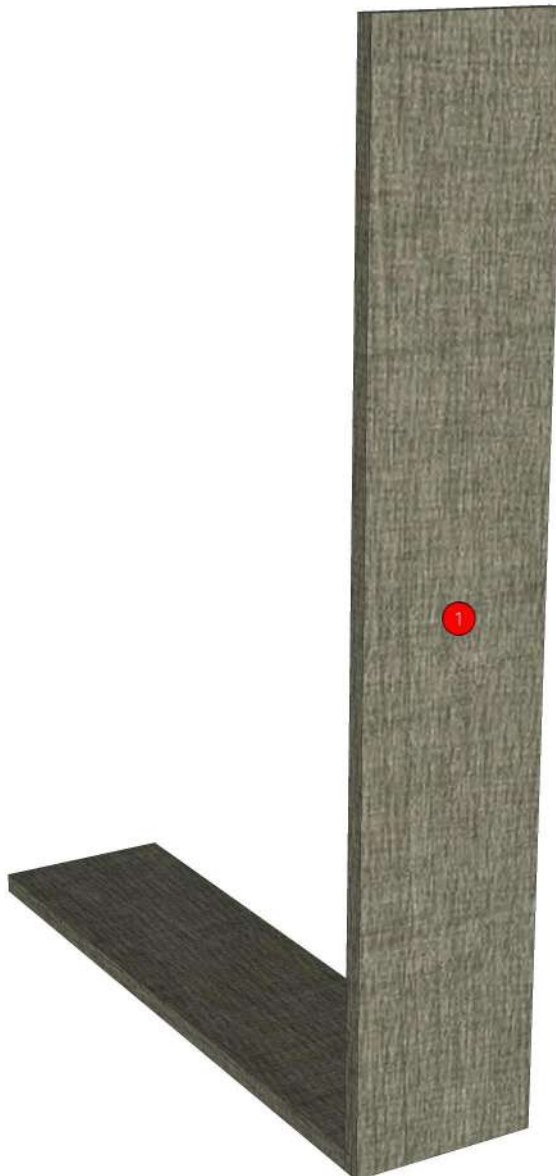

<b>Model</b>	-QUINTARA		
<b>Creator</b>	CHALEAMPON	<b>.BCP Name</b>	INDEX_C3D_KITCHEN2
<b>Reviewer</b>		<b>Order</b>	H000842
<b>Approves</b>		<b>Date</b>	17/02/2024

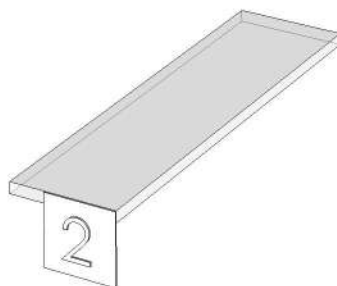
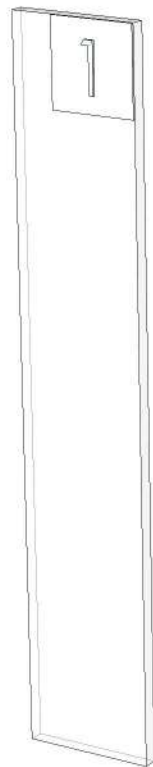

<b>Model</b>	QUINTARA_DFCL_2200		
<b>Creator</b>	CHALEAMPON	<b>.BCP Name</b>	INDEX_C3D_KITCHEN2
<b>Reviewer</b>		<b>Order</b>	H001567
<b>Approves</b>		<b>Date</b>	27/02/2025

## **QUINTARA\_DFCL\_2200-2200X9X120**

**Colour**

05.86=ML.EARTH TISSUE AX6 (TEXTILE)

**Edge**

01.408=1 AX6



K13R-160156520

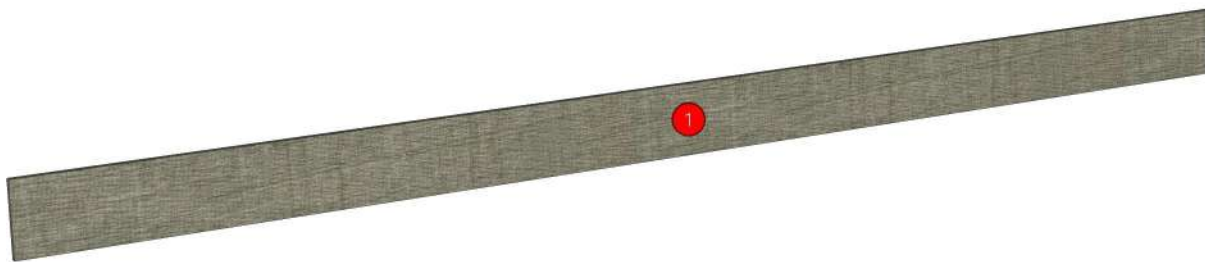

<b>Model</b>	QUINTARA_DFCL_2200		
<b>Creator</b>	CHALEAMPHON	<b>.BCP Name</b>	INDEX_C3D_KITCHEN2
<b>Reviewer</b>		<b>Order</b>	H001567
<b>Approves</b>		<b>Date</b>	27/02/2025

No.	Article No.	Description	Mat	Dimension	Cutting Size	Typepology	Skin
0	QUINTARA_DFCL_2200			2200x120x9			
	QUINTARA_DFCL_2200-01	FILLER TOP	PB-SP	9x120x2200	9X119X2199;L1:W1	183000_STR=05.86_EDG=AX6-1	2

<b>Model</b>	QUINTARA_DFCL_320		
<b>Creator</b>	CHALEAMPHON	<b>.BCP Name</b>	INDEX_C3D_KITCHEN2
<b>Reviewer</b>		<b>Order</b>	H000849
<b>Approves</b>		<b>Date</b>	17/02/2024

## QUINTARA\_DFCL\_320-320X9X120

**Colour**

05.86=ML.EARTH TISSUE AX6 (TEXTILE)

**Edge**

01.408=1 AX6

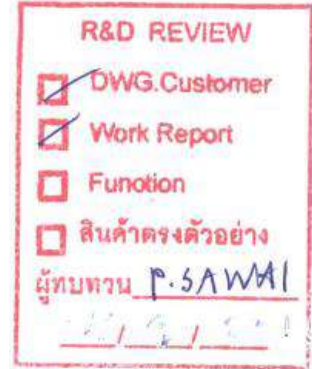

- K1L-160134919
- K1R-160140987
- K6R-160141005
- K8R-160134928
- K9L-160148447
- K10R-160148433
- K14L-160141014
- K14R-160134940
- K15R-160141023
- K2L-160156439
- K2R-160156447
- K4L-160156455
- K4R-160156463
- K5R-160156471
- K7L-160156480
- K11R-160156489
- K12R-160156505
- K13R-160156520
- K21L-160156542
- K21R-160156551

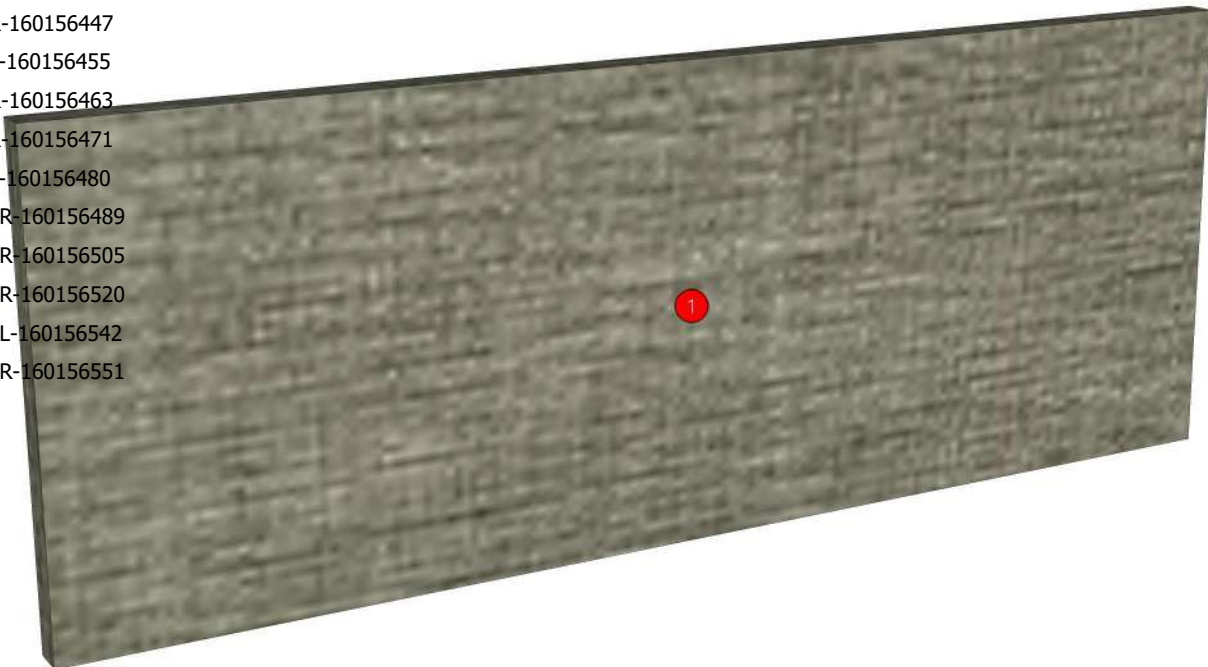

<b>Model</b>	QUINTARA_DFCL_320		
<b>Creator</b>	CHALEAMPHON	<b>.BCP Name</b>	INDEX_C3D_KITCHEN2
<b>Reviewer</b>		<b>Order</b>	H000849
<b>Approves</b>		<b>Date</b>	17/02/2024

No.	Article No.	Description	Mat	Dimension	Cutting Size	Typepology	Skin
0	QUINTARA_DFCL_320			320x120x9			
	QUINTARA_DFCL_320-01	FILLER TOP	PB-SP	9x120x320	9X119X319;L1:W1	183000_STR=05.86_EDG=AX6-1	2

<b>Model</b>	QUINTARA_DFL		
<b>Creator</b>	CHALEAMPON	<b>.BCP Name</b>	INDEX_C3D_KITCHEN2
<b>Reviewer</b>		<b>Order</b>	H000844
<b>Approves</b>		<b>Date</b>	17/02/2024

## **QUINTARA\_DFL-150X320X700**

**Colour**

05.86=ML.EARTH TISSUE AX6 (TEXTILE)

**Edge**

01.408=1 AX6

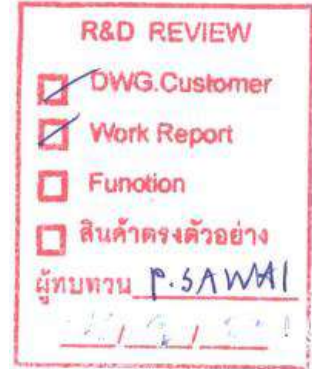

- K1L-160134919
- K1R-160140987
- K3L-160140996
- K9L-160148447
- K10R-160148433
- K15R-160141023
- K11R-160156489
- K13R-160156520
- K21L-160156542
- K21R-160156551



<b>Model</b>	-QUINTARA		
<b>Creator</b>	CHALEAMPON	<b>.BCP Name</b>	INDEX_C3D_KITCHEN2
<b>Reviewer</b>		<b>Order</b>	H000844
<b>Approves</b>		<b>Date</b>	17/02/2024

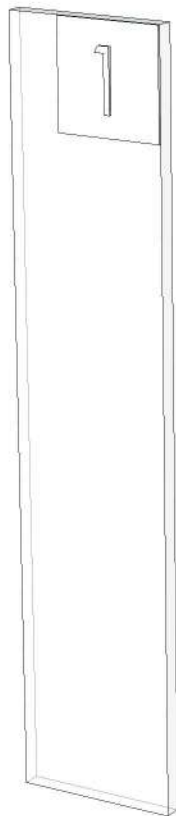
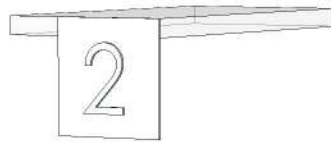

<b>Model</b>	QUINTARA_DL60		
<b>Creator</b>	CHALEAMPHON	<b>.BCP Name</b>	INDEX_C3D_KITCHEN2
<b>Reviewer</b>		<b>Order</b>	H001546
<b>Approves</b>		<b>Date</b>	21/02/2025

## **QUINTARA\_DL60-600X320X700**

**Colour**

05.86=ML.EARTH TISSUE AX6 (TEXTILE)

**Edge**

01.408=1 AX6

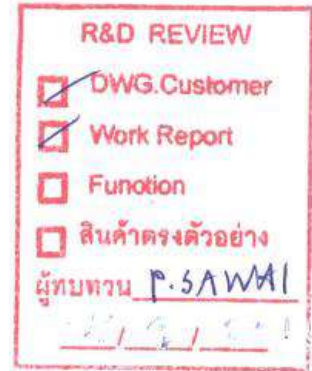

K13R-160156520

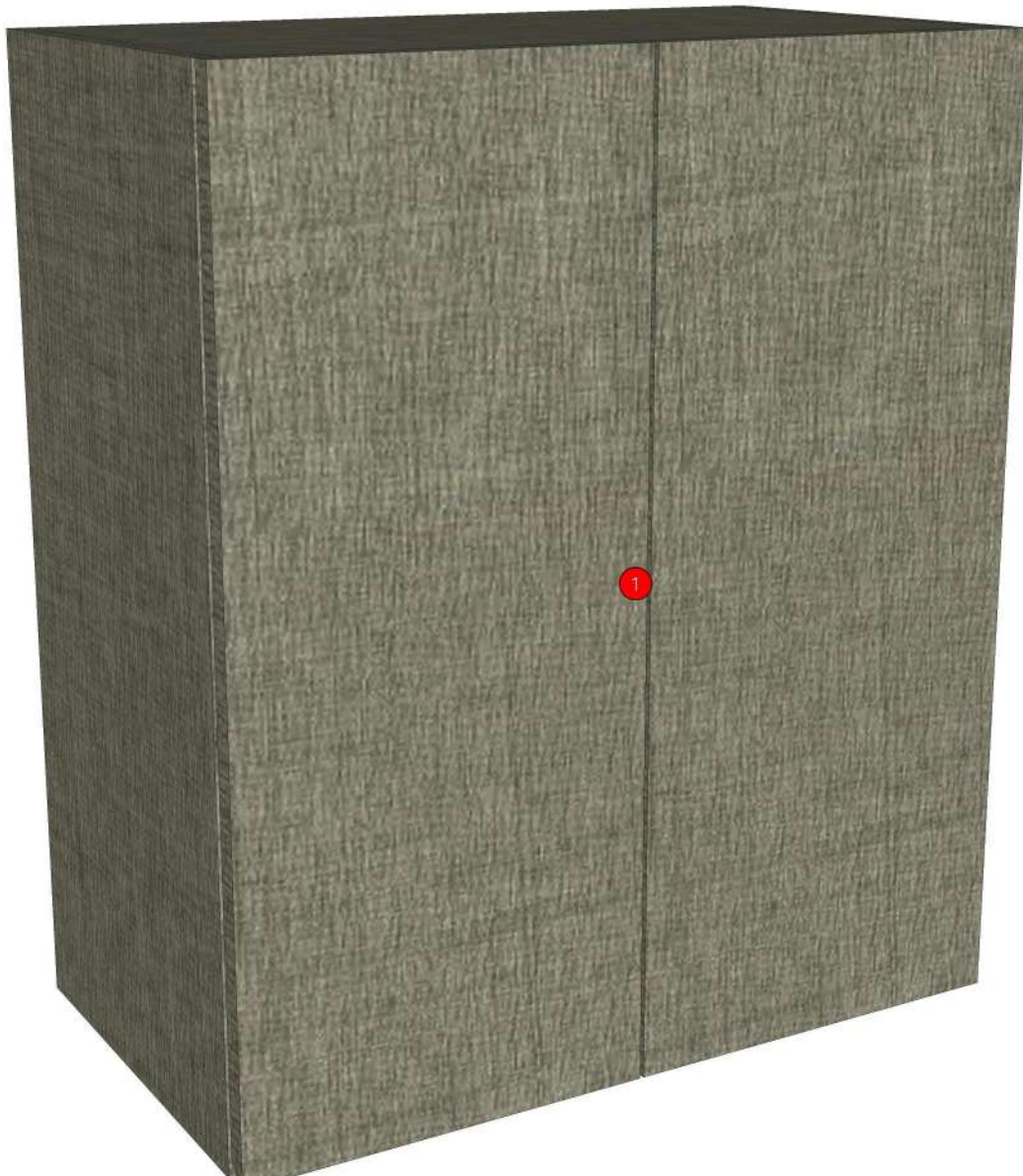

<b>Model</b>	-QUINTARA		
<b>Creator</b>	CHALEAMPON	<b>.BCP Name</b>	INDEX_C3D_KITCHEN2
<b>Reviewer</b>		<b>Order</b>	H001546
<b>Approves</b>		<b>Date</b>	21/02/2025

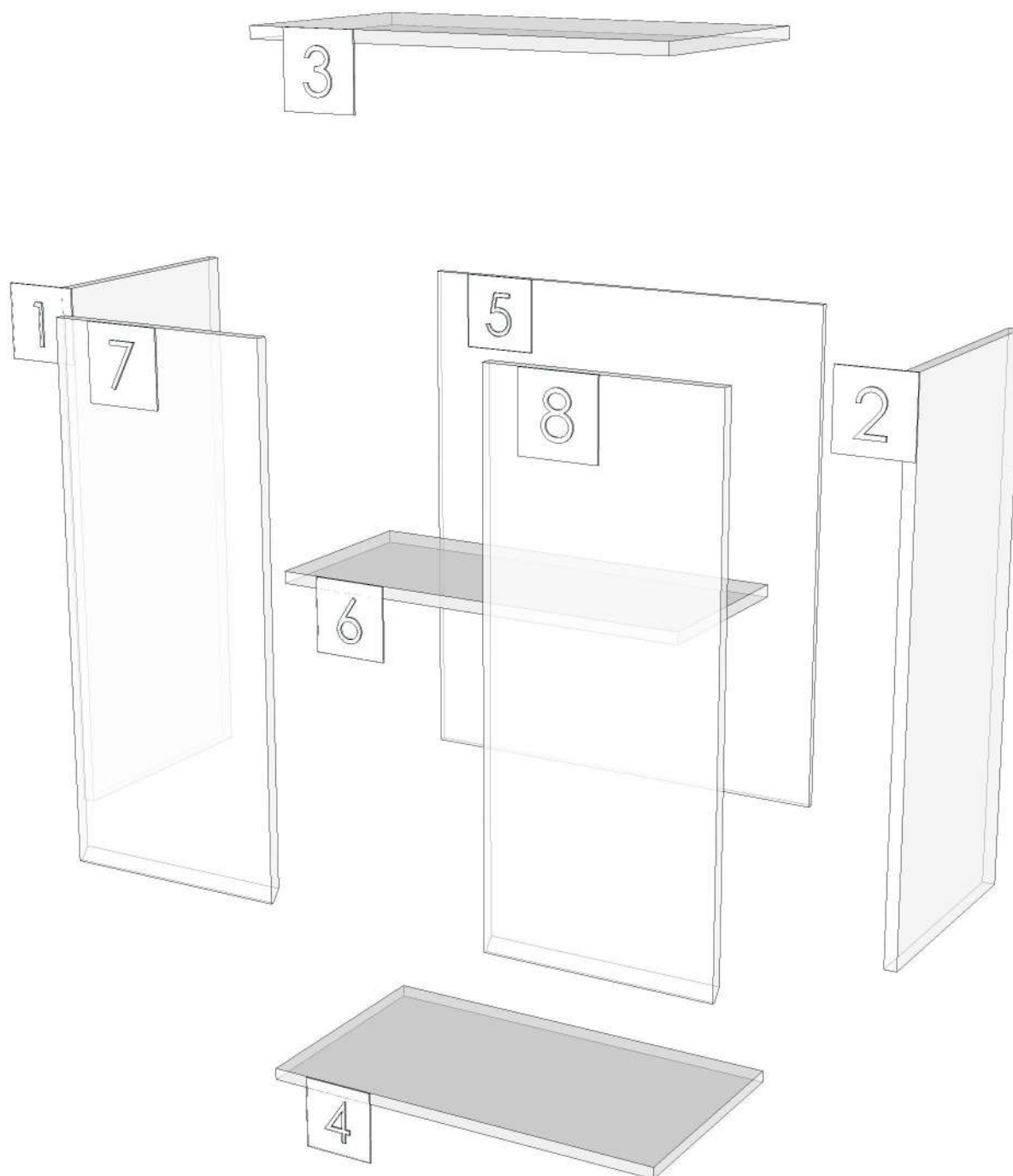

<b>Model</b>	QUINTARA_DL60H1R		
<b>Creator</b>	CHALEAMPHON	<b>.BCP Name</b>	INDEX_C3D_KITCHEN2
<b>Reviewer</b>		<b>Order</b>	H001548
<b>Approves</b>		<b>Date</b>	21/02/2025

## QUINTARA\_DL60H1R-600X320X600

**Colour**

05.86=ML.EARTH TISSUE AX6 (TEXTILE)

**Edge**

01.408=1 AX6

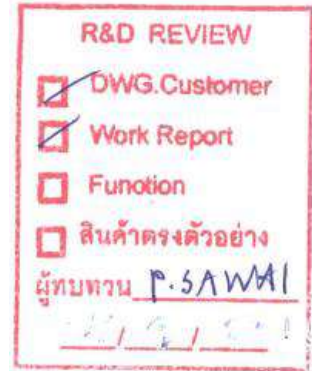

- K2L-160156439
- K4L-160156455
- K7L-160156480
- K11R-160156489
- K12R-160156505
- K13R-160156520
- K21L-160156542

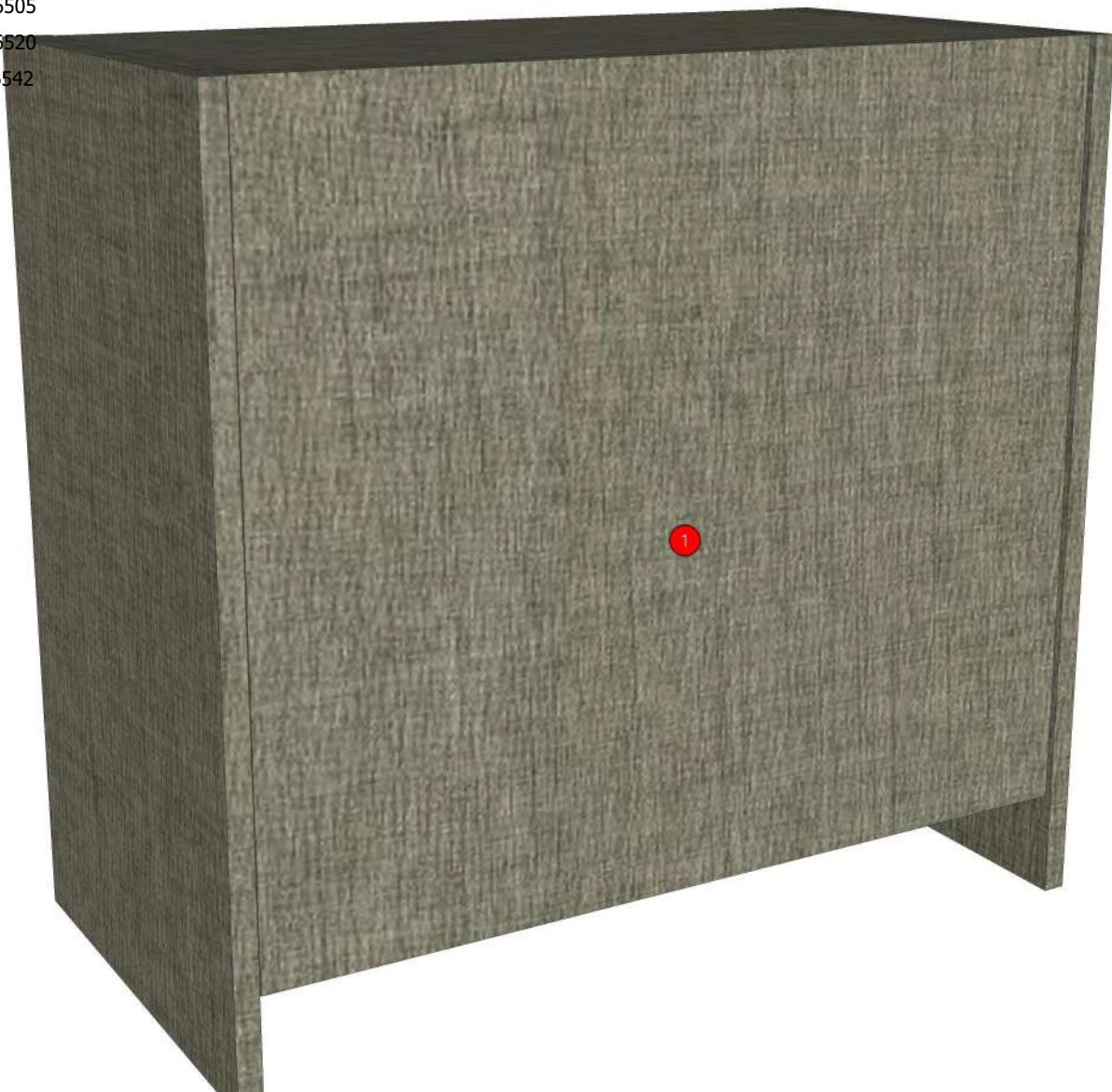

<b>Model</b>	-QUINTARA		
<b>Creator</b>	CHALEAMPON	<b>.BCP Name</b>	INDEX_C3D_KITCHEN2
<b>Reviewer</b>		<b>Order</b>	H001548
<b>Approves</b>		<b>Date</b>	21/02/2025

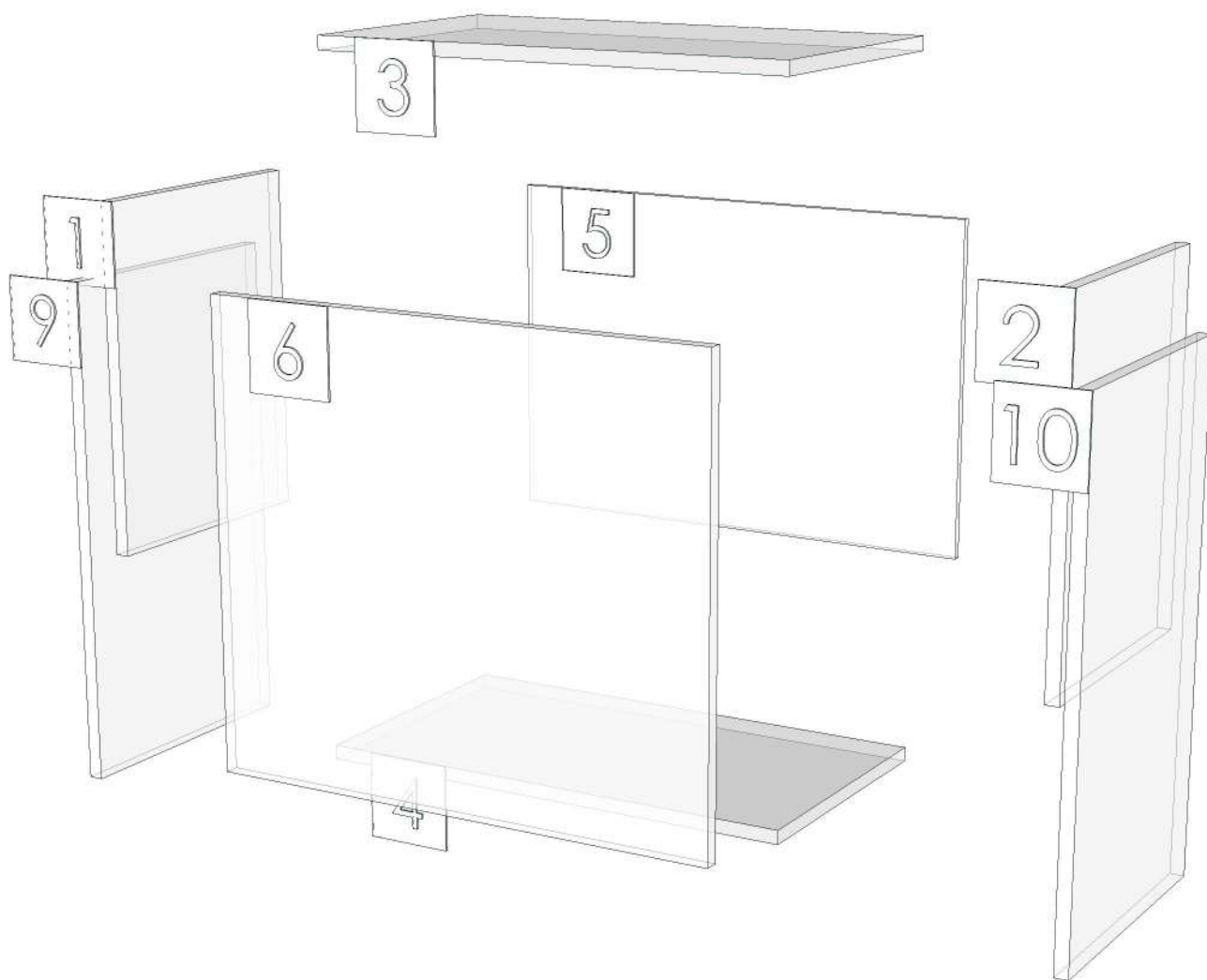

<b>Model</b>	QUINTARA_DPLT_1698		
<b>Creator</b>	CHALEAMPHON	<b>.BCP Name</b>	INDEX_C3D_KITCHEN2
<b>Reviewer</b>		<b>Order</b>	H001572
<b>Approves</b>		<b>Date</b>	27/02/2025

## **QUINTARA\_DPLT\_1698-1698X9X100**

**Colour**

05.86=ML.EARTH TISSUE AX6 (TEXTILE)

**Edge**

01.408=1 AX6



K13R-160156520

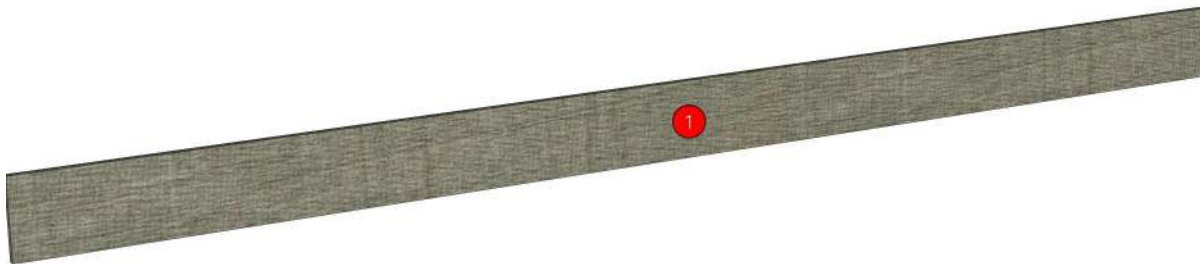

<b>Model</b>	QUINTARA_DPLT_1698		
<b>Creator</b>	CHALEAMPHON	<b>.BCP Name</b>	INDEX_C3D_KITCHEN2
<b>Reviewer</b>		<b>Order</b>	H001572
<b>Approves</b>		<b>Date</b>	27/02/2025

No.	Article No.	Description	Mat	Dimension	Cutting Size	Typepology	Skin
0	QUINTARA_DPLT_1698			1698x100x9			
	QUINTARA_DPLT_1698-01	LED BOTTOM	PB-SP	9x100x1698	9X98X1696;L2:W2	183000_STR=05.86_EDG=AX6-1	2



<b>Model</b>	QUINTARA_DPLT_1800		
<b>Creator</b>	CHALEAMPHON	<b>.BCP Name</b>	INDEX_C3D_KITCHEN2
<b>Reviewer</b>		<b>Order</b>	H001573
<b>Approves</b>		<b>Date</b>	27/02/2025

No.	Article No.	Description	Mat	Dimension	Cutting Size	Typepology	Skin
0	QUINTARA_DPLT_1800			1800x100x9			
	QUINTARA_DPLT_1800-01	LED BOTTOM	PB-SP	9x100x1800	9X98X1799;L2:W1	183000_STR=05.86_EDG=AX6-1	2

<b>Model</b>	QUINTARA_DPLT_2200		
<b>Creator</b>	CHALEAMPHON	<b>.BCP Name</b>	INDEX_C3D_KITCHEN2
<b>Reviewer</b>		<b>Order</b>	H001575
<b>Approves</b>		<b>Date</b>	27/02/2025

## **QUINTARA\_DPLT\_2200-2200X9X100**

**Colour**

05.86=ML.EARTH TISSUE AX6 (TEXTILE)

**Edge**

01.408=1 AX6



K13R-160156520

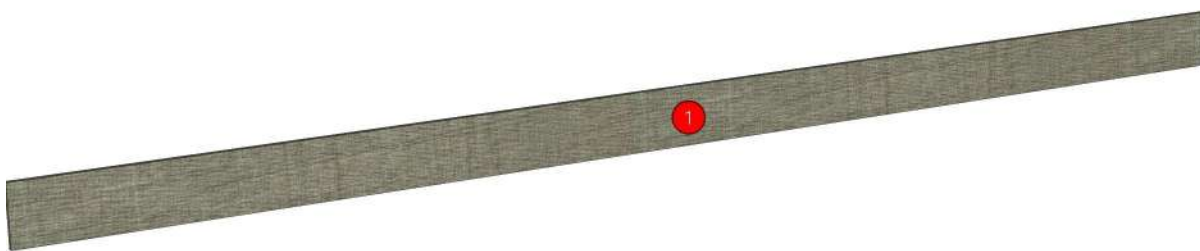

<b>Model</b>	QUINTARA_DPLT_2200		
<b>Creator</b>	CHALEAMPHON	<b>.BCP Name</b>	INDEX_C3D_KITCHEN2
<b>Reviewer</b>		<b>Order</b>	H001575
<b>Approves</b>		<b>Date</b>	27/02/2025

No.	Article No.	Description	Mat	Dimension	Cutting Size	Typepology	Skin
0	QUINTARA_DPLT_2200			2200x100x9			
	QUINTARA_DPLT_2200-01	LED BOTTOM	PB-SP	9x100x2200	9X98X2199;L2:W1	183000_STR=05.86_EDG=AX6-1	2

<b>Model</b>	QUINTARA_DPLT_600		
<b>Creator</b>	CHALEAMPHON	<b>.BCP Name</b>	INDEX_C3D_KITCHEN2
<b>Reviewer</b>		<b>Order</b>	H000851
<b>Approves</b>		<b>Date</b>	19/02/2024

## QUINTARA\_DPLT\_600-600X9X100

**Colour**

05.86=ML.EARTH TISSUE AX6 (TEXTILE)

**Edge**

01.408=1 AX6



- K1L-160134919
- K1R-160140987
- K3L-160140996
- K6R-160141005
- K8R-160134928
- K9L-160148447
- K10R-160148433
- K14L-160141014
- K14R-160134940
- K15R-160141023
- K2L-160156439
- K2R-160156447
- K4L-160156455
- K4R-160156463
- K5R-160156471
- K7L-160156480
- K11R-160156489
- K12R-160156505
- K13R-160156520
- K21L-160156542
- K21R-160156551
- K22L-1601

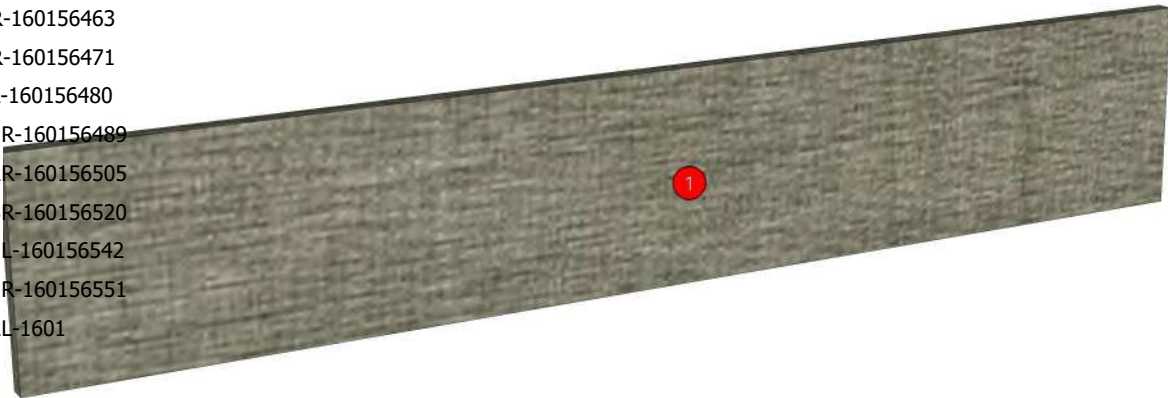

<b>Model</b>	QUINTARA_DPLT_600		
<b>Creator</b>	CHALEAMPHON	<b>.BCP Name</b>	INDEX_C3D_KITCHEN2
<b>Reviewer</b>		<b>Order</b>	H000851
<b>Approves</b>		<b>Date</b>	19/02/2024

No.	Article No.	Description	Mat	Dimension	Cutting Size	Typepology	Skin
0	QUINTARA_DPLT_600			600x100x9			
	QUINTARA_DPLT_600-01	LED BOTTOM	PB-SP	9x100x584	9X98X582;L2:W2	183000_STR=05.86_EDG=AX6-1	2

<b>Model</b>	QUINTARA_DW868		
<b>Creator</b>	CHALEAMPON	<b>.BCP Name</b>	INDEX_C3D_KITCHEN2
<b>Reviewer</b>		<b>Order</b>	H001553
<b>Approves</b>		<b>Date</b>	27/02/2025

## **QUINTARA\_DW868-868X320X350**

**Colour**

05.86=ML.EARTH TISSUE AX6 (TEXTILE)

**Edge**

01.408=1 AX6



K13R-160156520

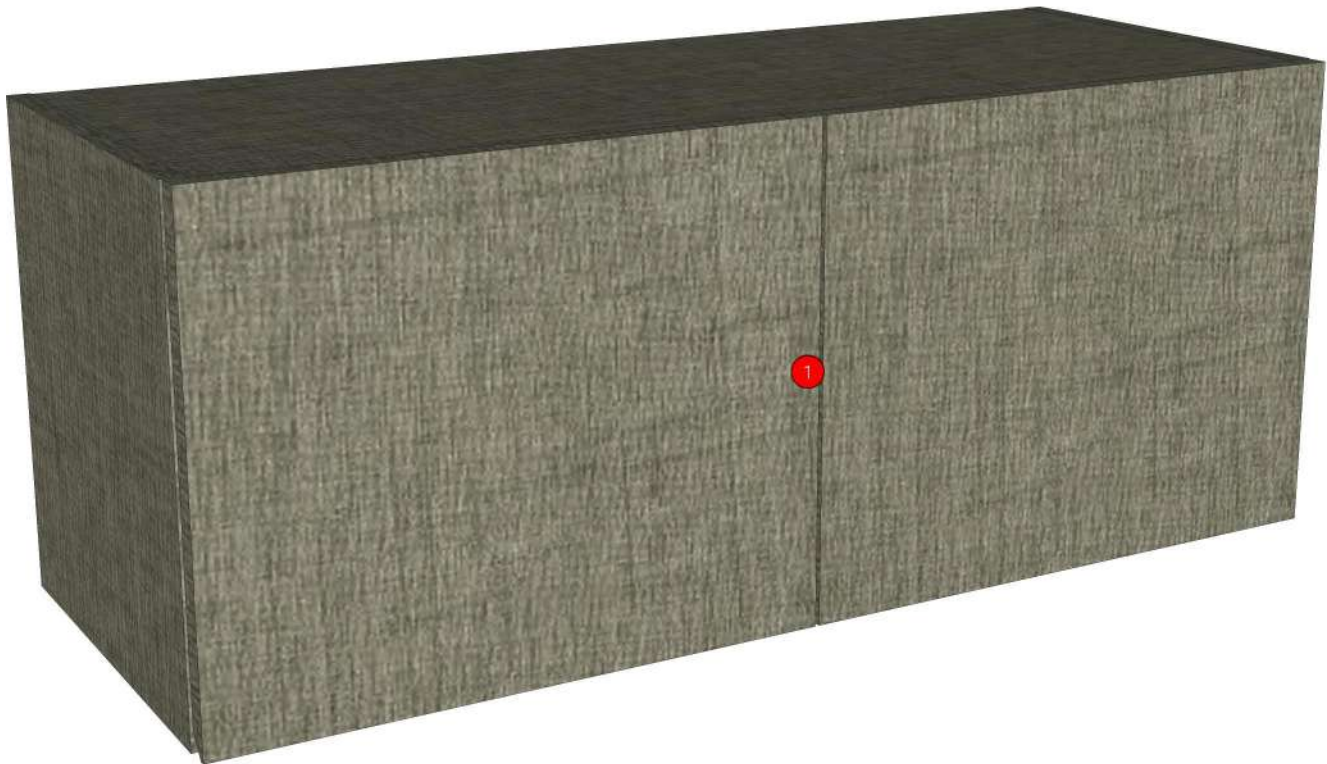

<b>Model</b>	-QUINTARA		
<b>Creator</b>	CHALEAMPON	<b>.BCP Name</b>	INDEX_C3D_KITCHEN2
<b>Reviewer</b>		<b>Order</b>	H001553
<b>Approves</b>		<b>Date</b>	27/02/2025

