

Model	NICHE_BP_DBH602		
Creator	CHALEAMPHON	.BCP Name	INDEX_C3D_KITCHEN2
Reviewer		Order	H000462
Approves		Date	30/04/2024

NICHE_BP_DBH602-600X570X738

Colour

02.61=FOIL 75GMS.MD627(VALENTINO)AQ-346-15KBWG(AQ PAPER)
02.62=FOIL 75GMS.MD216(SANSTONE)AQ-264KB(AQ PAPER)
06.01=TEXTURE DEAD STOCK

Edge

01.261=1 MD627
01.253=1 MD216



- K100L-160137586
- K100R-160122251
- K102-160137594
- K104L-160137602
- K104R-160122259
- K105-160122268
- K106-160137611
- K108-160137620
- K103-160148602
- K107-160148618
- K1000L-160154943
- K1000R-160154951
- K1004L-160154973
- K1004R-160154982
- K1005-160154991
- K1006-160155000
- K1008-160155009



Model	-NICHE_BP		
Creator	CHALEAMPHON	.BCP Name	INDEX_C3D_KITCHEN2
Reviewer		Order	H000462
Approves		Date	30/04/2024

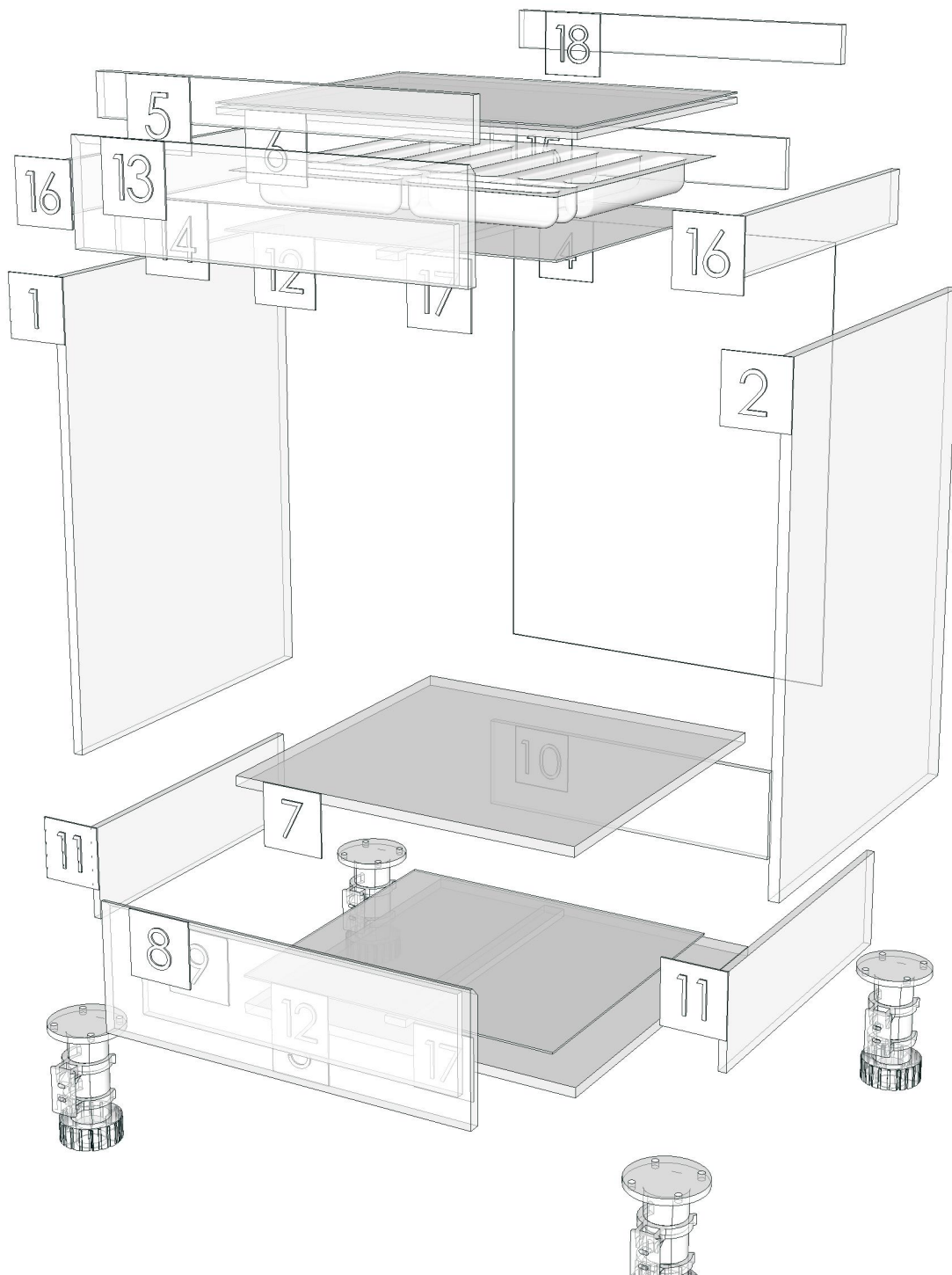

Model	NICHE_BP_DBS60L		
Creator	CHALEAMPHON	.BCP Name	INDEX_C3D_KITCHEN2
Reviewer		Order	H000463
Approves		Date	30/04/2024

NICHE_BP_DBS60L-600X570X738

Colour

02.61=FOIL 75GMS.MD627(VALENTINO)AQ-346-15KBWG(AQ PAPER)

02.62=FOIL 75GMS.MD216(SANSTONE)AQ-264KB(AQ PAPER)

Edge

01.261=1 MD627

01.253=1 MD216



K100L-160137586

K102-160137594

K1000L-160154943



Model	-NICHE_BP		
Creator	CHALEAMPHON	.BCP Name	INDEX_C3D_KITCHEN2
Reviewer		Order	H000463
Approves		Date	30/04/2024

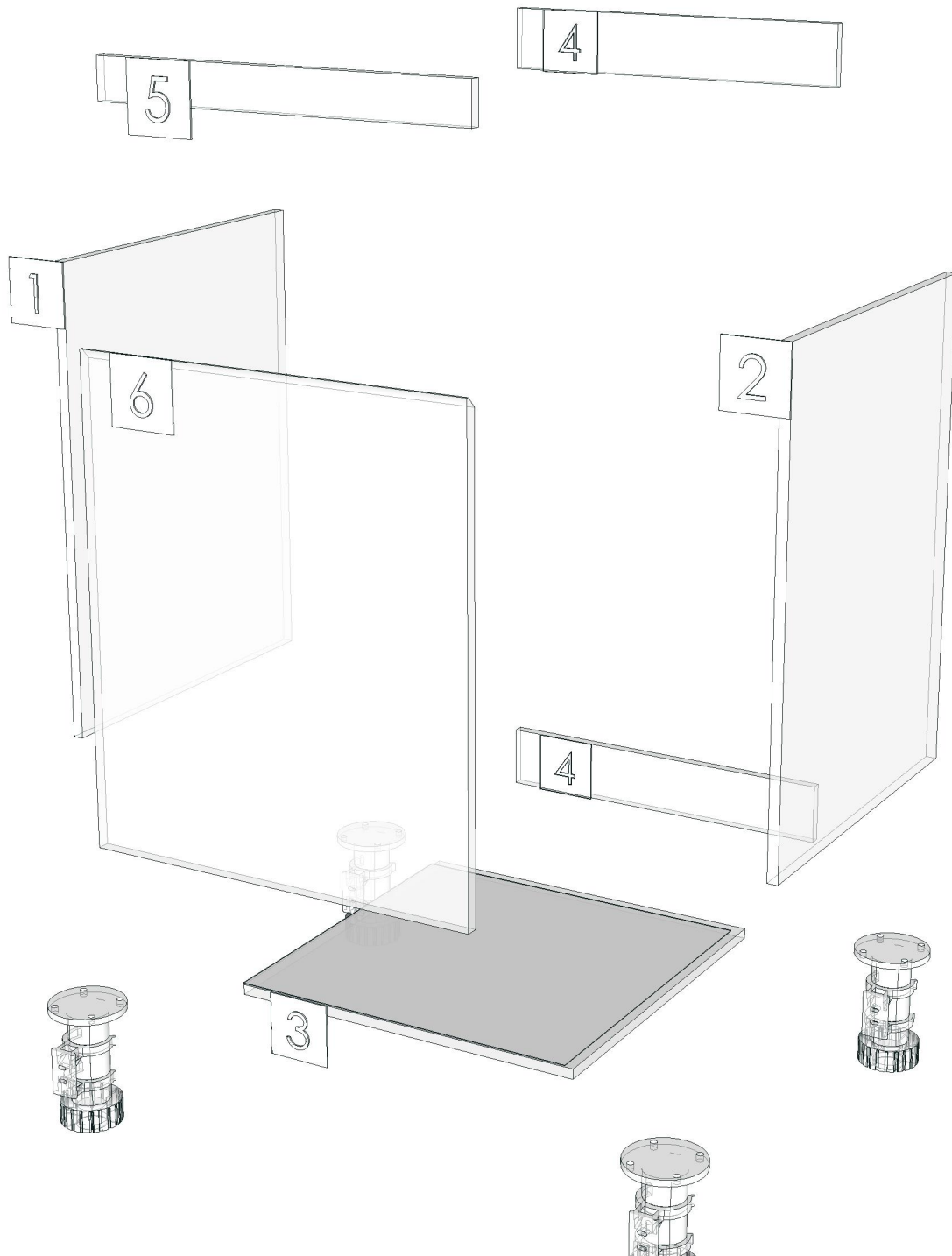

Model	NICHE_BP_DDM1200		
Creator	CHALEAMPON	.BCP Name	INDEX_C3D_KITCHEN2
Reviewer		Order	H000473
Approves		Date	29/04/2024

NICHE_BP_DDM1200-1200X6X550

Colour

03.13=PVC WHITE#630 T0.15MM.

Edge



- K100L-160137586
- K100R-160122251
- K1000L-160154943
- K1000R-160154951

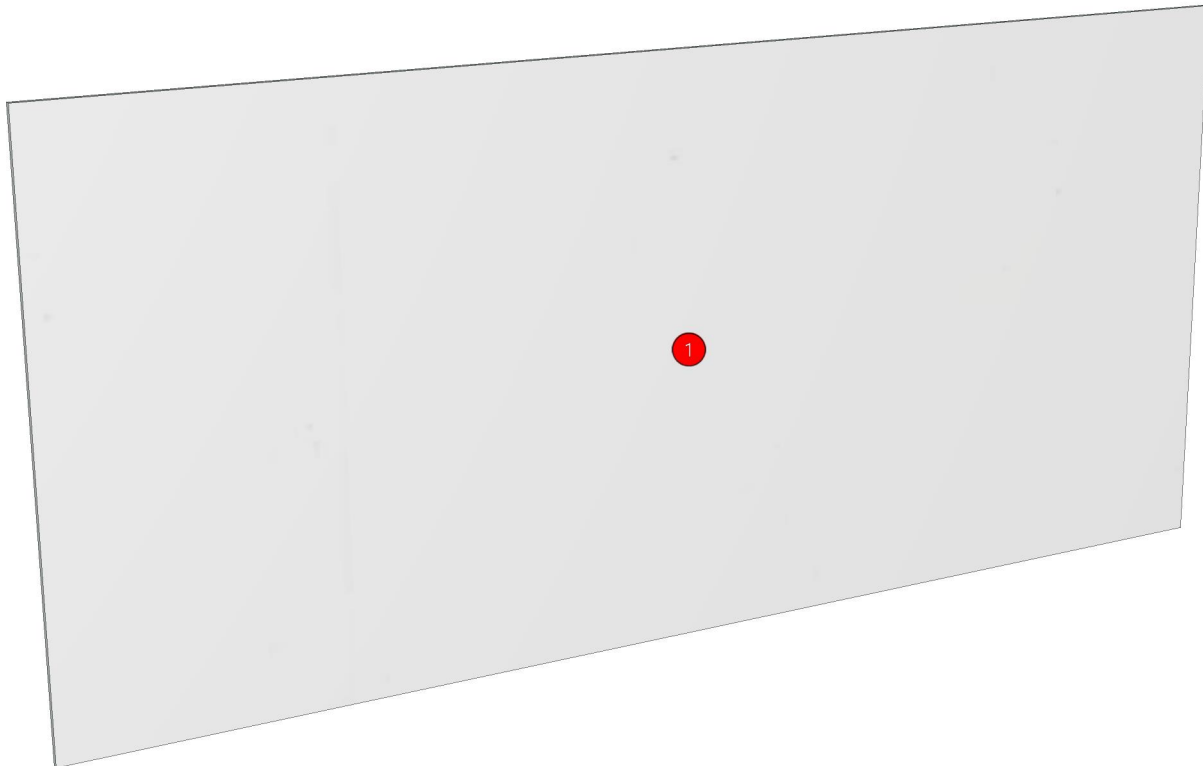

Model	NICHE_BP_DDM1200		
Creator	CHALEAMPHON	.BCP Name	INDEX_C3D_KITCHEN2
Reviewer		Order	H000473
Approves		Date	29/04/2024

No.	Article No.	Description	Mat	Dimension	Cutting Size	Typepology	Skin
0	NICHE_BP_DDM1200			1200x550x6			
	NICHE_BP_DDM1200-01	WALL MOUNT	MDF-SP	6x550x1200	6X550X1200;NO EDGE	183000_STR=03.13_EDG=-	2

Model	NICHE_BP_DFCL_1200		
Creator	CHALEAMPHON	.BCP Name	INDEX_C3D_KITCHEN2
Reviewer		Order	H000477
Approves		Date	29/04/2024

NICHE_BP_DFCL_1200-1200X16X148

Colour

02.61=FOIL 75GMS.MD627(VALENTINO)AQ-346-15KBWG(AQ PAPER)

02.62=FOIL 75GMS.MD216(SANSTONE)AQ-264KB(AQ PAPER)

Edge

01.261=1 MD627

01.253=1 MD216



K100L-160137586
K100R-160122251
K1000L-160154943
K1000R-160154951

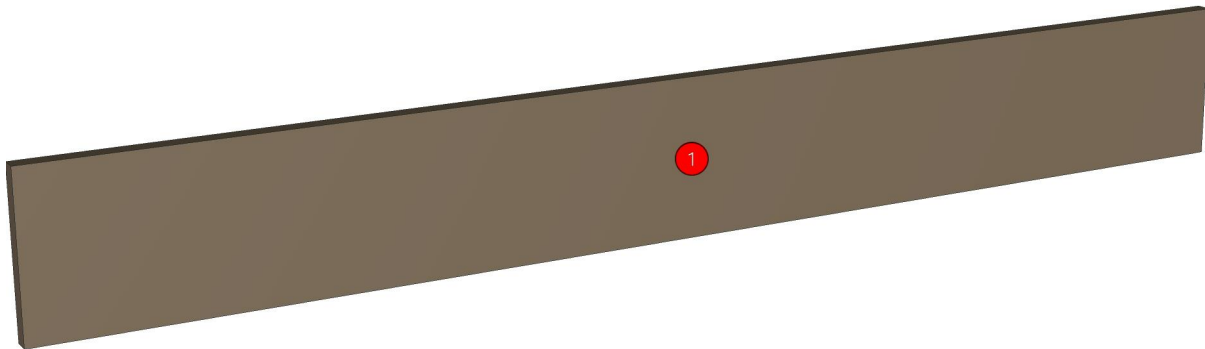

Model	NICHE_BP_DFCL_1200		
Creator	CHALEAMPHON	.BCP Name	INDEX_C3D_KITCHEN2
Reviewer		Order	H000477
Approves		Date	29/04/2024

No.	Article No.	Description	Mat	Dimension	Cutting Size	Typepology	Skin
0	NICHE_BP_DFCL_1200			1200x148x16			
	NICHE_BP_DFCL_1200-01	FILLER TOP_(WP_4)	PB-SP	16x148x1200	16X148X1198;L0:W2	183000 _STR=02.62 _EDG=MD216-1	2

Model	NICHE_BP_DFCL_350		
Creator	CHALEAMPON	.BCP Name	INDEX_C3D_KITCHEN2
Reviewer		Order	H000480
Approves		Date	29/04/2024

NICHE_BP_DFCL_350-350X16X148

Colour

02.61=FOIL 75GMS.MD627(VALENTINO)AQ-346-15KBWG(AQ PAPER)
02.62=FOIL 75GMS.MD216(SANSTONE)AQ-264KB(AQ PAPER)

Edge

01.261=1 MD627
01.253=1 MD216



K100L-160137586
K100R-160122251
K102-160137594
K104L-160137602
K104R-160122259
K106-160137611
K108-160137620
K107-160148618
K1000L-160154943
K1000R-160154951
K1004L-160154973
K1004R-160154982
K1006-160155000
K1008-160155009

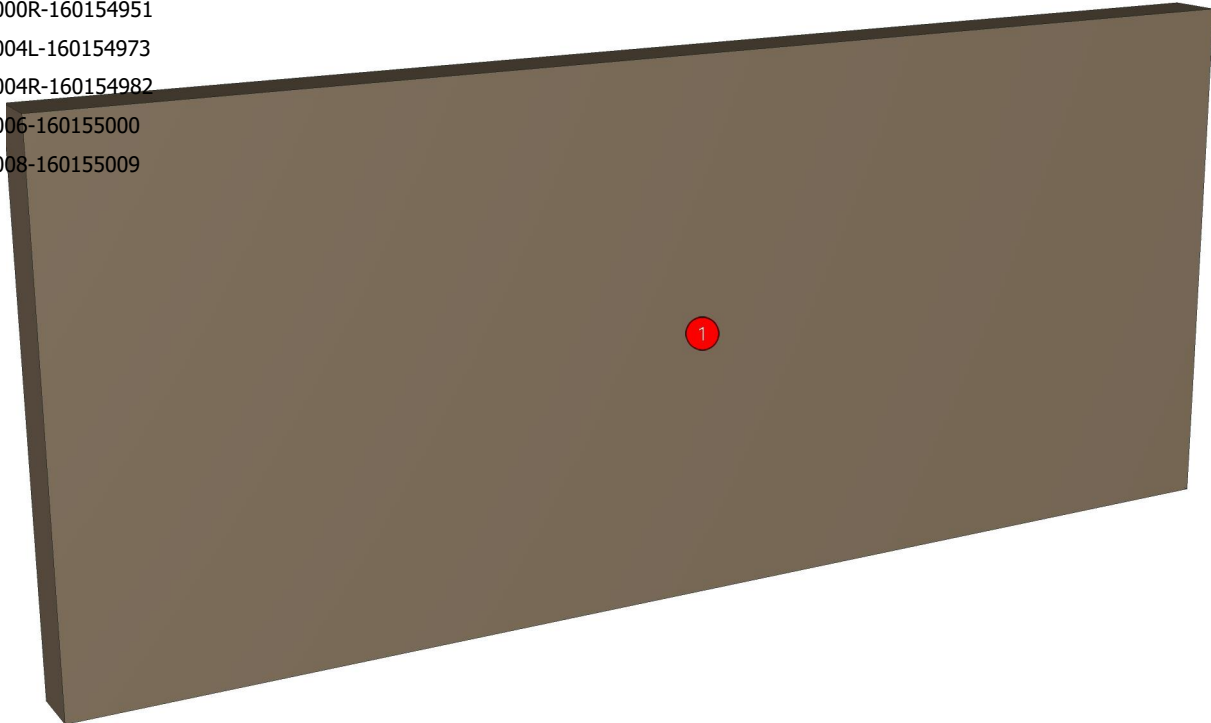

Model	NICHE_BP_DFCL_350		
Creator	CHALEAMPHON	.BCP Name	INDEX_C3D_KITCHEN2
Reviewer		Order	H000480
Approves		Date	29/04/2024

No.	Article No.	Description	Mat	Dimension	Cutting Size	Typepology	Skin
0	NICHE_BP_DFCL_350			350x148x16			
	NICHE_BP_DFCL_350-01	FILLER TOP-SIDE_(WP_4)	PB-SP	16x148x350	16X148X348;L0:W2	183000 _STR=02.62 _EDG=MD216-1	2

Model	NICHE_BP_DL60HRS(N)		
Creator	CHALEAMPHON	.BCP Name	INDEX_C3D_KITCHEN2
Reviewer		Order	H001503
Approves		Date	24/01/2025

NICHE_BP_DL60HRS(N)-600X350X800

Colour

02.61=FOIL 75GMS.MD627(VALENTINO)AQ-346-15KBWG(AQ PAPER)

02.62=FOIL 75GMS.MD216(SANSTONE)AQ-264KB(AQ PAPER)

Edge

01.261=1 MD627

01.253=1 MD216



K1000L-160154943

K1004L-160154973

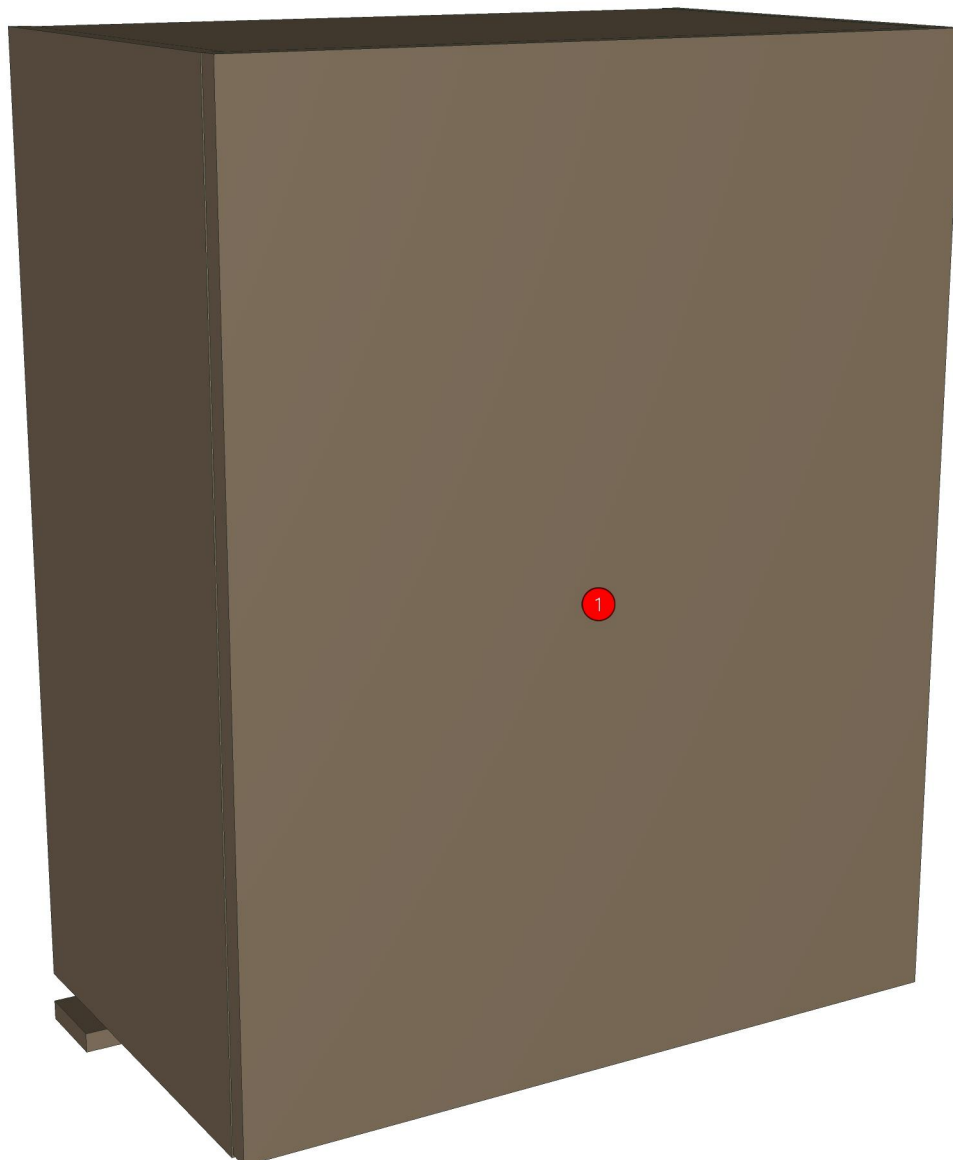

Model	-NICHE_BP		
Creator	CHALEAMPON	.BCP Name	INDEX_C3D_KITCHEN2
Reviewer		Order	H001503
Approves		Date	24/01/2025

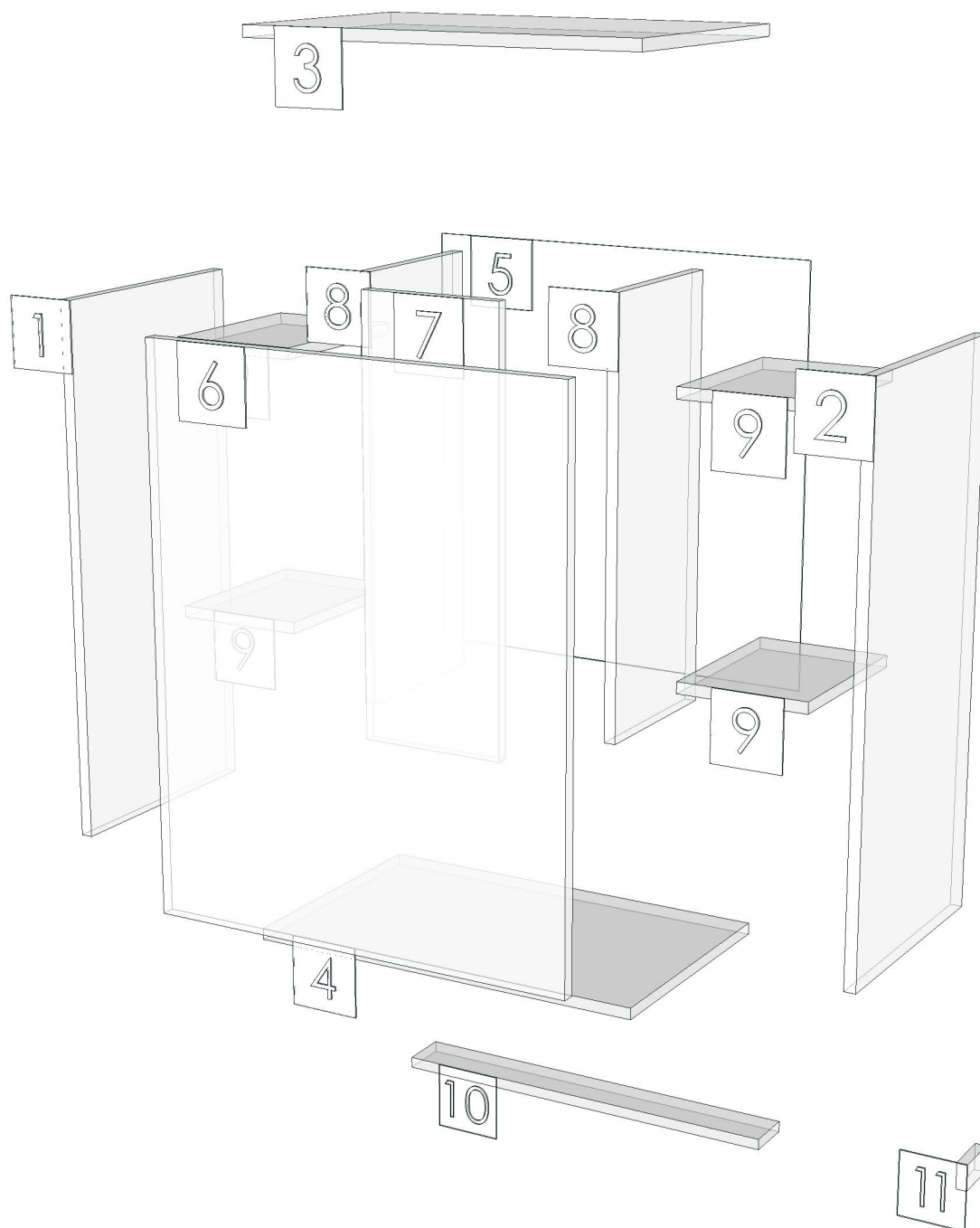

Model	NICHE_BP_DL60LS		
Creator	CHALEAMPHON	.BCP Name	INDEX_C3D_KITCHEN2
Reviewer		Order	H000464
Approves		Date	30/04/2024

NICHE_BP_DL60LS-600X350X800

Colour

02.61=FOIL 75GMS.MD627(VALENTINO)AQ-346-15KBWG(AQ PAPER)
02.62=FOIL 75GMS.MD216(SANSTONE)AQ-264KB(AQ PAPER)

Edge

01.261=1 MD627
01.253=1 MD216



- K100L-160137586
- K102-160137594
- K108-160137620
- K103-160148602
- K1000L-160154943
- K1008-160155009

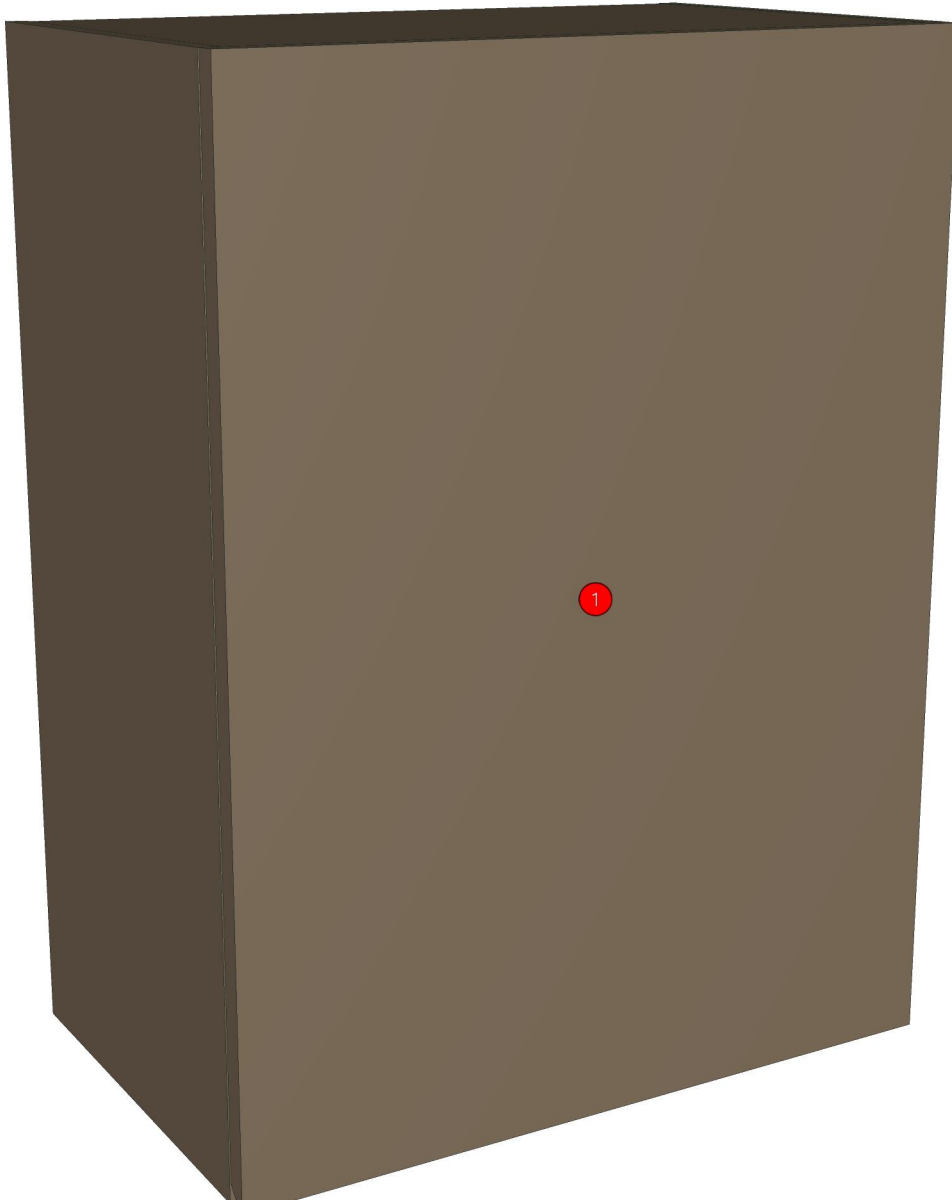

Model	-NICHE_BP		
Creator	CHALEAMPHON	.BCP Name	INDEX_C3D_KITCHEN2
Reviewer		Order	H000464
Approves		Date	30/04/2024

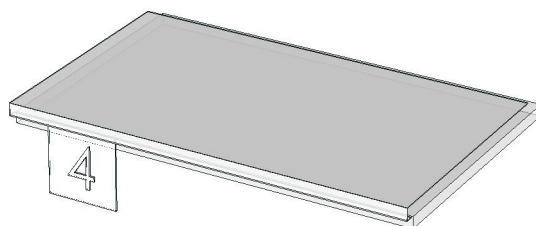
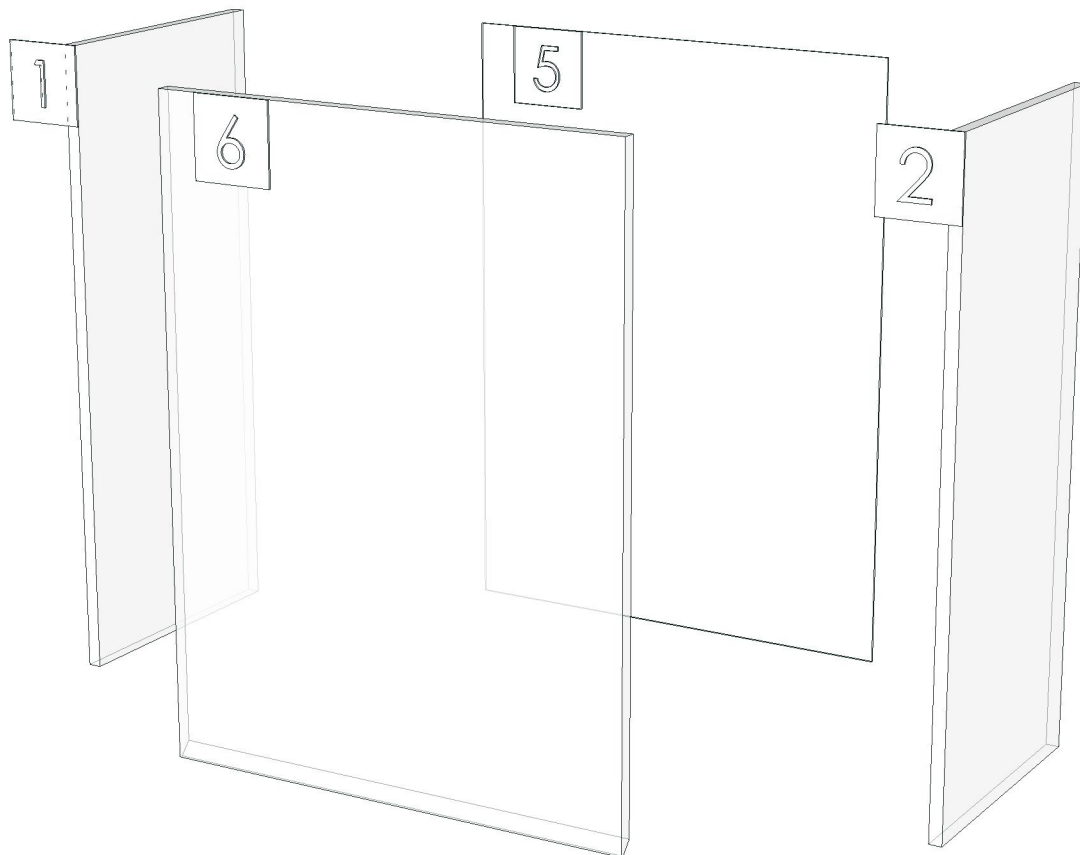
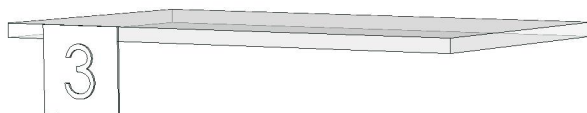

Model	NICHE_BP_DPLT_600		
Creator	CHALEAMPHON	.BCP Name	INDEX_C3D_KITCHEN2
Reviewer		Order	H000487
Approves		Date	29/04/2024

NICHE_BP_DPLT_600-600X9X100

Colour

02.61=FOIL 75GMS.MD627(VALENTINO)AQ-346-15KBWG(AQ PAPER)

02.62=FOIL 75GMS.MD216(SANSTONE)AQ-264KB(AQ PAPER)

Edge

01.261=1 MD627

01.253=1 MD216



- K100L-160137586
- K100R-160122251
- K102-160137594
- K104L-160137602
- K104R-160122259
- K105-160122268
- K106-160137611
- K108-160137620
- K103-160148602
- K107-160148618
- K1000L-160154943
- K1000R-160154951
- K1004L-160154973
- K1004R-160154982
- K1005-160154991
- K1006-160155000
- K1008-160155009

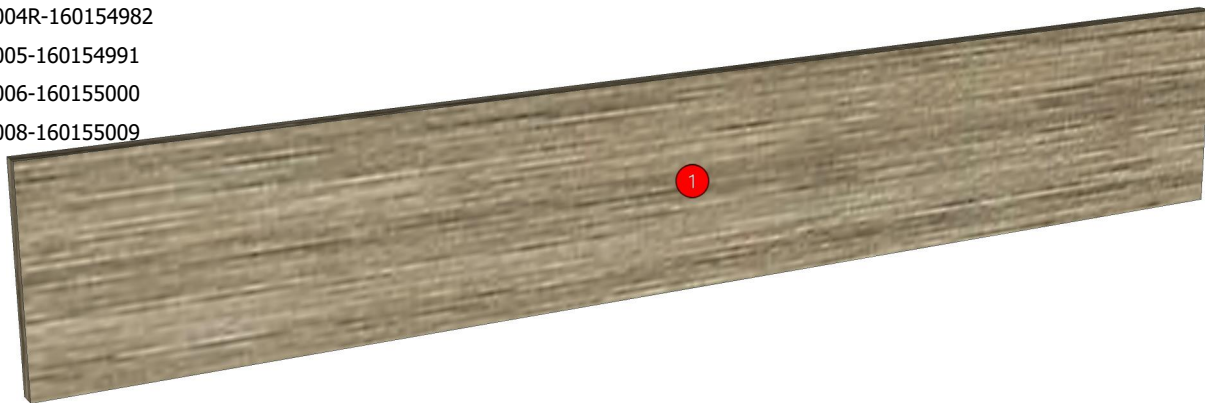

Model	NICHE_BP_DPLT_600		
Creator	CHALEAMPHON	.BCP Name	INDEX_C3D_KITCHEN2
Reviewer		Order	H000487
Approves		Date	29/04/2024

No.	Article No.	Description	Mat	Dimension	Cutting Size	Typepology	Skin
0	NICHE_BP_DPLT_600			600x100x9			
	NICHE_BP_DPLT_600-01	LEG_(WP_4)	PB-SP	9x98x600	9X98X598;L0:W2	183000 _STR=02.61 _EDG=MD627-1	2

Model	NICHE_BP_DPLT_1200		
Creator	CHALEAMPON	.BCP Name	INDEX_C3D_KITCHEN2
Reviewer		Order	H000485
Approves		Date	29/04/2024

NICHE_BP_DPLT_1200-1200X9X98

Colour

02.61=FOIL 75GMS.MD627(VALENTINO)AQ-346-15KBWG(AQ PAPER)

02.62=FOIL 75GMS.MD216(SANSTONE)AQ-264KB(AQ PAPER)

Edge

01.261=1 MD627

01.253=1 MD216



K100L-160137586
K100R-160122251
K1000L-160154943
K1000R-160154951

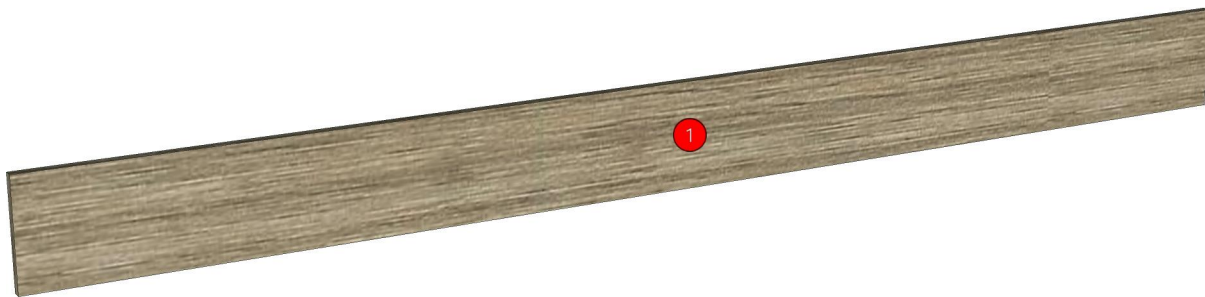

Model	NICHE_BP_DPLT_1200		
Creator	CHALEAMPHON	.BCP Name	INDEX_C3D_KITCHEN2
Reviewer		Order	H000485
Approves		Date	29/04/2024

No.	Article No.	Description	Mat	Dimension	Cutting Size	Typepology	Skin
0	NICHE_BP_DPLT_1200			1200x98x9			
	NICHE_BP_DPLT_1200-01	LEG_(WP_4)	PB-SP	9x98x1200	9X98X1198;L0:W2	183000 _STR=02.61 _EDG=MD627-1	2