

<b>Model</b>	ADLER_DBH60R	<b>Name</b>	INDEX_C3D_KITCHENPAE
<b>Creator</b>	SUTTHI.P	<b>Order</b>	O002063
<b>Reviewer</b>		<b>Date</b>	05/11/2024
<b>Approves</b>			

## **ADLER\_DBH60R-600X570X760**

### **Colour**

05.67=ML.WHITE LAVA MARBLE#BT5 (SUPPER MATT)

05.66=ML.WOOD OAK#BT4 (MATT WOODGRIN)

20.07=ML.WHITE #VM1012 18/18(MATT)

### **Edge**

01.380=1 ML.WHITE LAVA MARBLE BT5

01.369=1 WOOD OAK (BT4)

01.47=1 WHITE

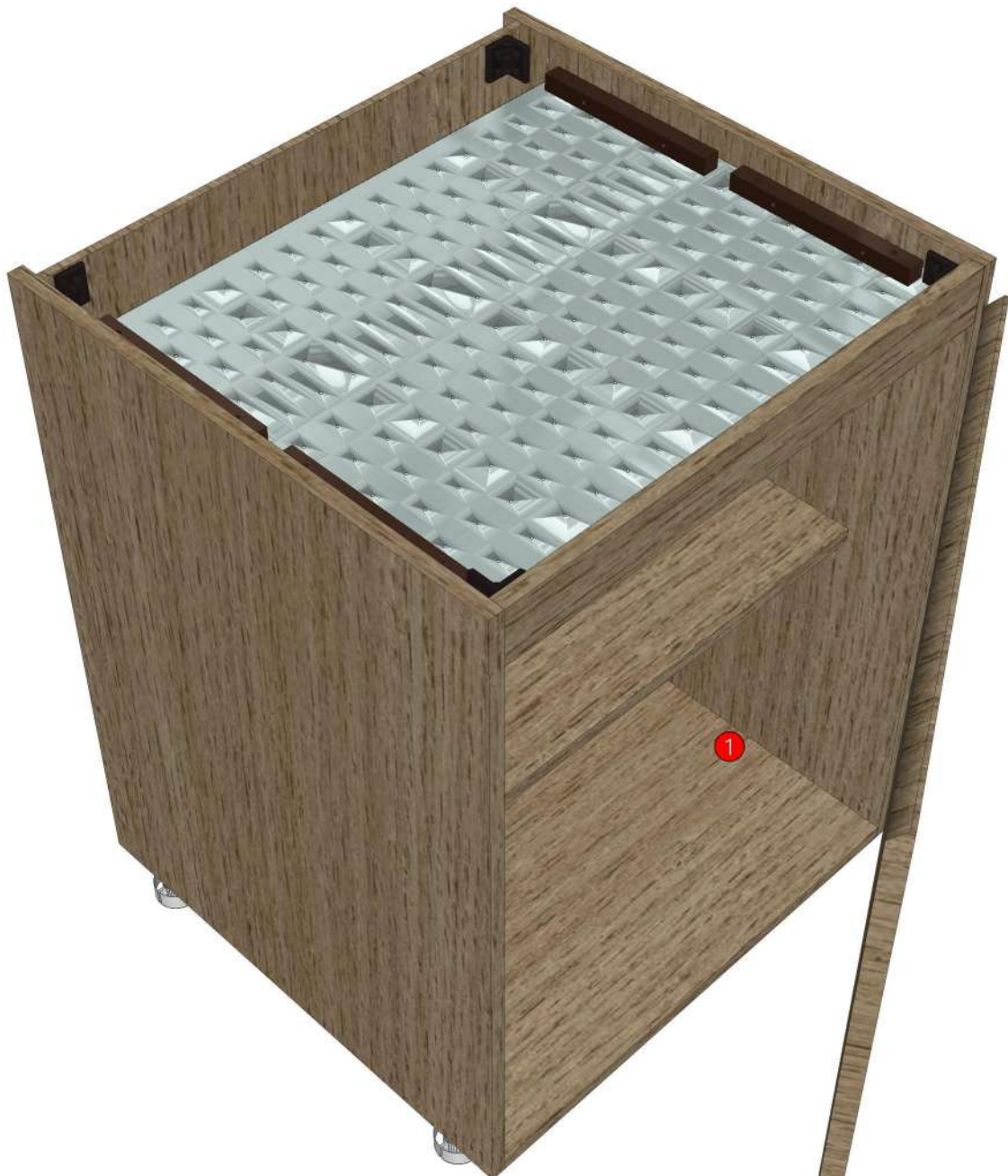

<b>Model</b>	-ADLER_DBH60R		
<b>Creator</b>	SUTTHI.P	<b>Name</b>	INDEX_C3D_KITCHENPAE
<b>Reviewer</b>		<b>Order</b>	O002063
<b>Approves</b>		<b>Date</b>	05/11/2024

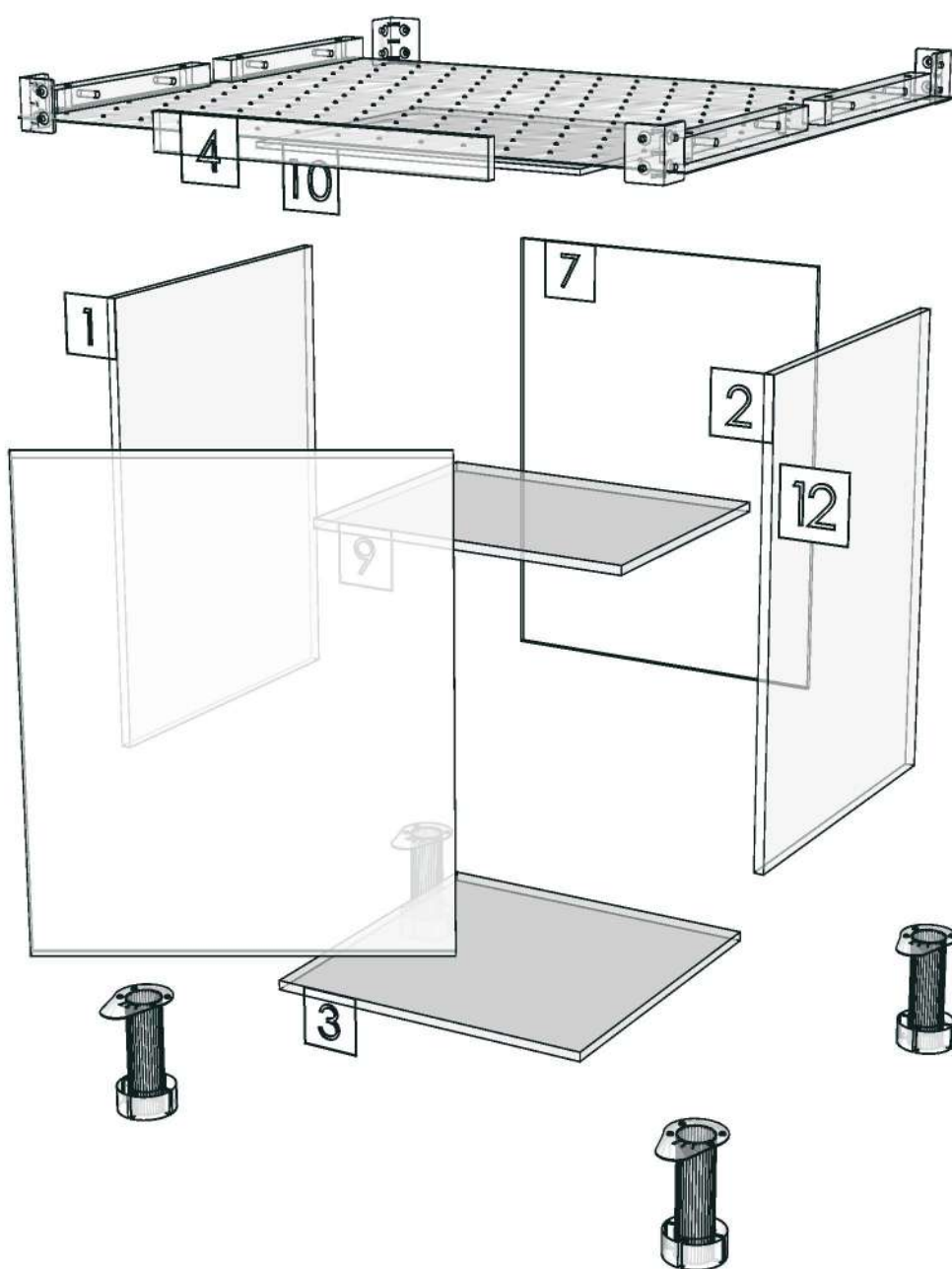

<b>Model</b>	ADLER_DBH60L		
<b>Creator</b>	SUTTHI.P	<b>Name</b>	INDEX_C3D_KITCHENPAE
<b>Reviewer</b>		<b>Order</b>	O002062
<b>Approves</b>		<b>Date</b>	04/11/2024

## **ADLER\_DBH60L-600X570X760**

### **Colour**

05.67=ML.WHITE LAVA MARBLE#BT5 (SUPPER MATT)

05.66=ML.WOOD OAK#BT4 (MATT WOODGRIN)

20.07=ML.WHITE #VM1012 18/18(MATT)

### **Edge**

01.380=1 ML.WHITE LAVA MARBLE BT5

01.369=1 WOOD OAK (BT4)

01.47=1 WHITE

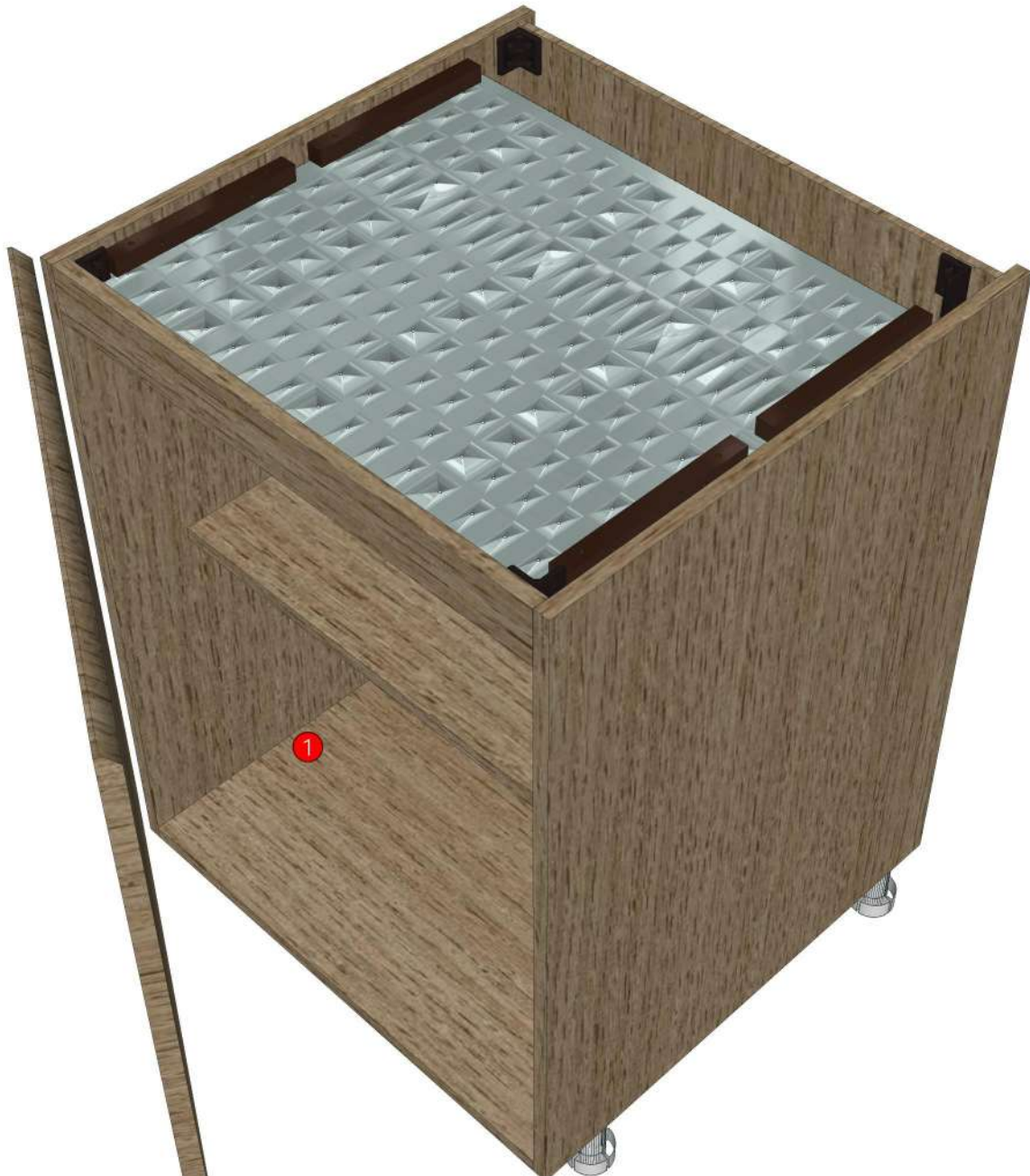

<b>Model</b>	-ADLER_DBH60L		
<b>Creator</b>	SUTTHI.P	<b>Name</b>	INDEX_C3D_KITCHENPAE
<b>Reviewer</b>		<b>Order</b>	O002062
<b>Approves</b>		<b>Date</b>	04/11/2024

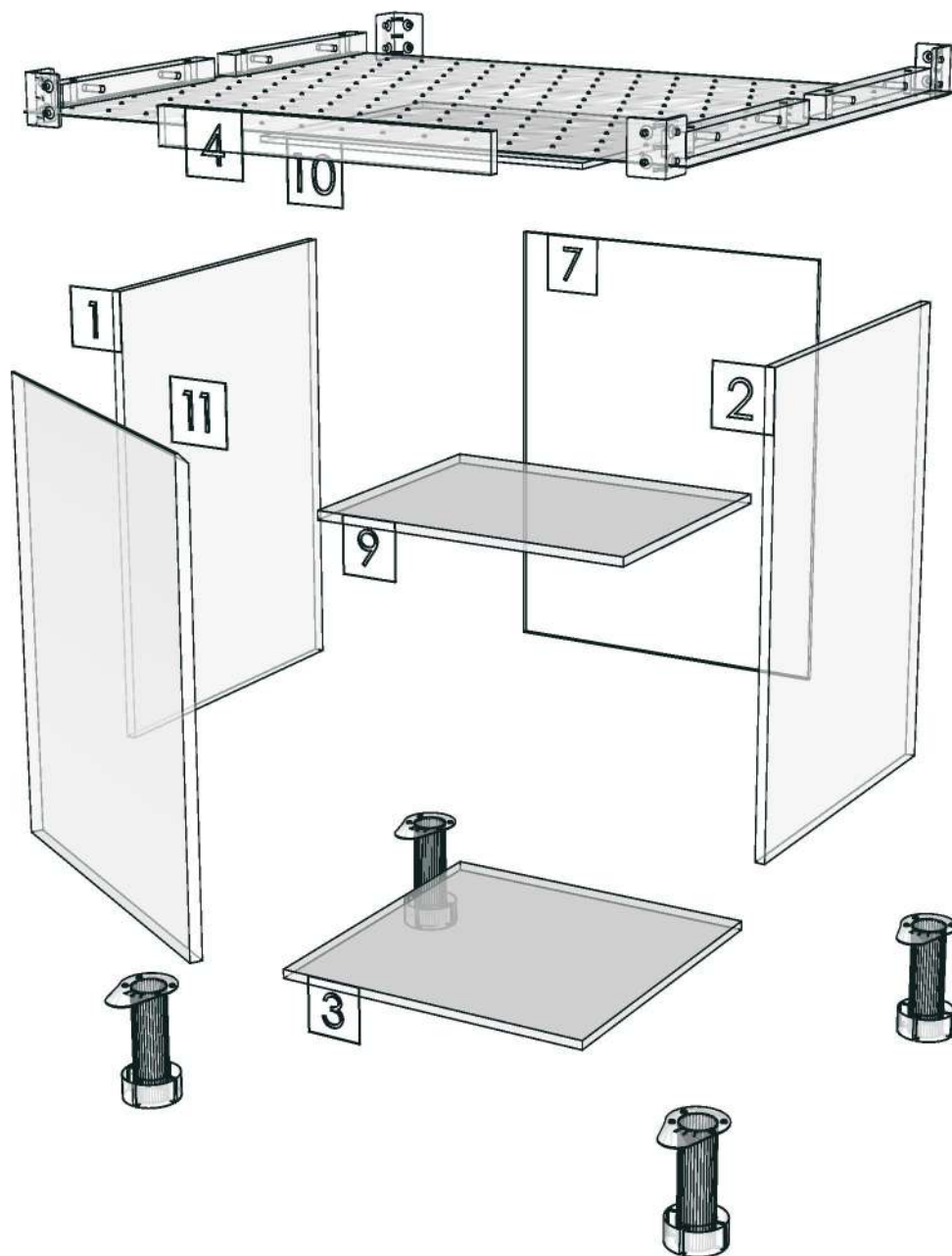

<b>Model</b>	ADLER_DBS1145		
<b>Creator</b>	SUTTHI.P	<b>Name</b>	INDEX_C3D_KITCHENPAE
<b>Reviewer</b>		<b>Order</b>	O002054
<b>Approves</b>		<b>Date</b>	04/11/2024

## **ADLER\_DBS1145-1145X570X760**

### **Colour**

05.67=ML.WHITE LAVA MARBLE#BT5 (SUPPER MATT)

05.66=ML.WOOD OAK#BT4 (MATT WOODGRIN)

20.07=ML.WHITE #VM1012 18/18(MATT)

### **Edge**

01.380=1 ML.WHITE LAVA MARBLE BT5

01.369=1 WOOD OAK (BT4)

01.47=1 WHITE

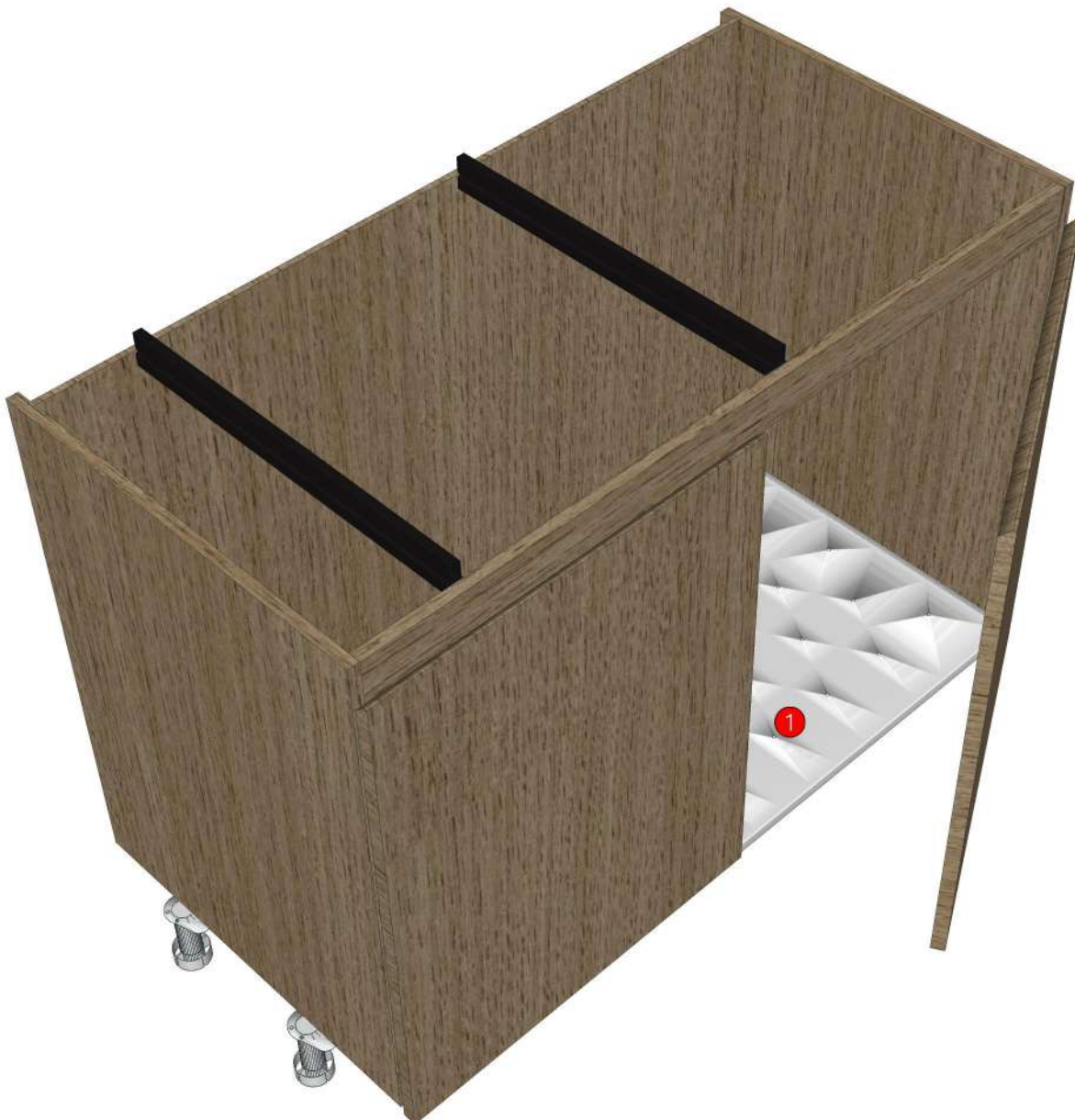

<b>Model</b>	-ADLER_DBS1145		
<b>Creator</b>	SUTTHI.P	<b>Name</b>	INDEX_C3D_KITCHENPAE
<b>Reviewer</b>		<b>Order</b>	O002054
<b>Approves</b>		<b>Date</b>	04/11/2024

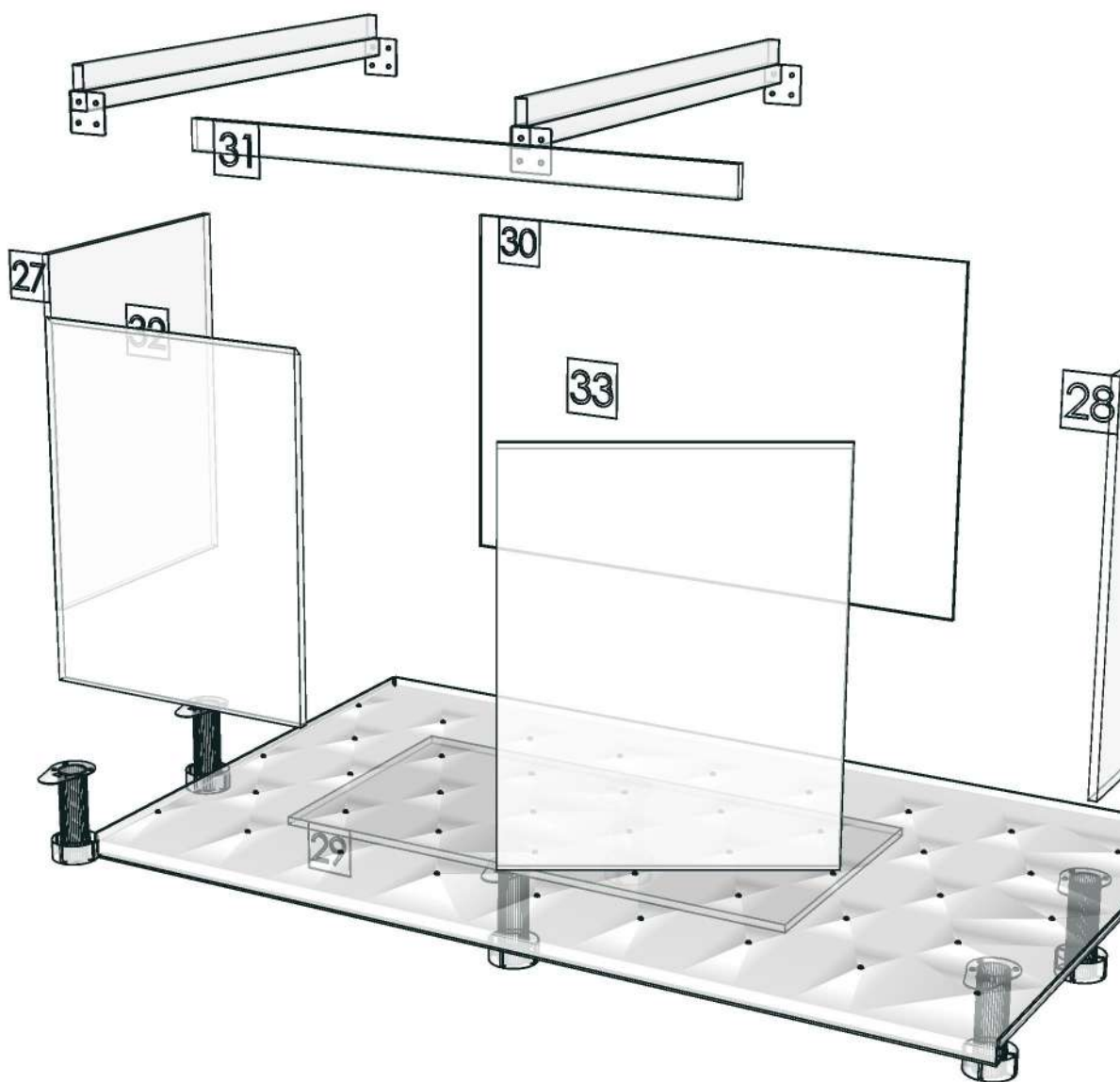

<b>Model</b>	ADLER_DFL		
<b>Creator</b>	SUTTHI.P	<b>Name</b>	INDEX_C3D_KITCHENPAE
<b>Reviewer</b>		<b>Order</b>	O002140
<b>Approves</b>		<b>Date</b>	12/12/2024

## **ADLER\_DFL-150X300X830**

### **Colour**

05.67=ML.WHITE LAVA MARBLE#BT5 (SUPPER MATT)

05.66=ML.WOOD OAK#BT4 (MATT WOODGRIN)

20.07=ML.WHITE #VM1012 18/18(MATT)

### **Edge**

01.380=1 ML.WHITE LAVA MARBLE BT5

01.369=1 WOOD OAK (BT4)

01.47=1 WHITE

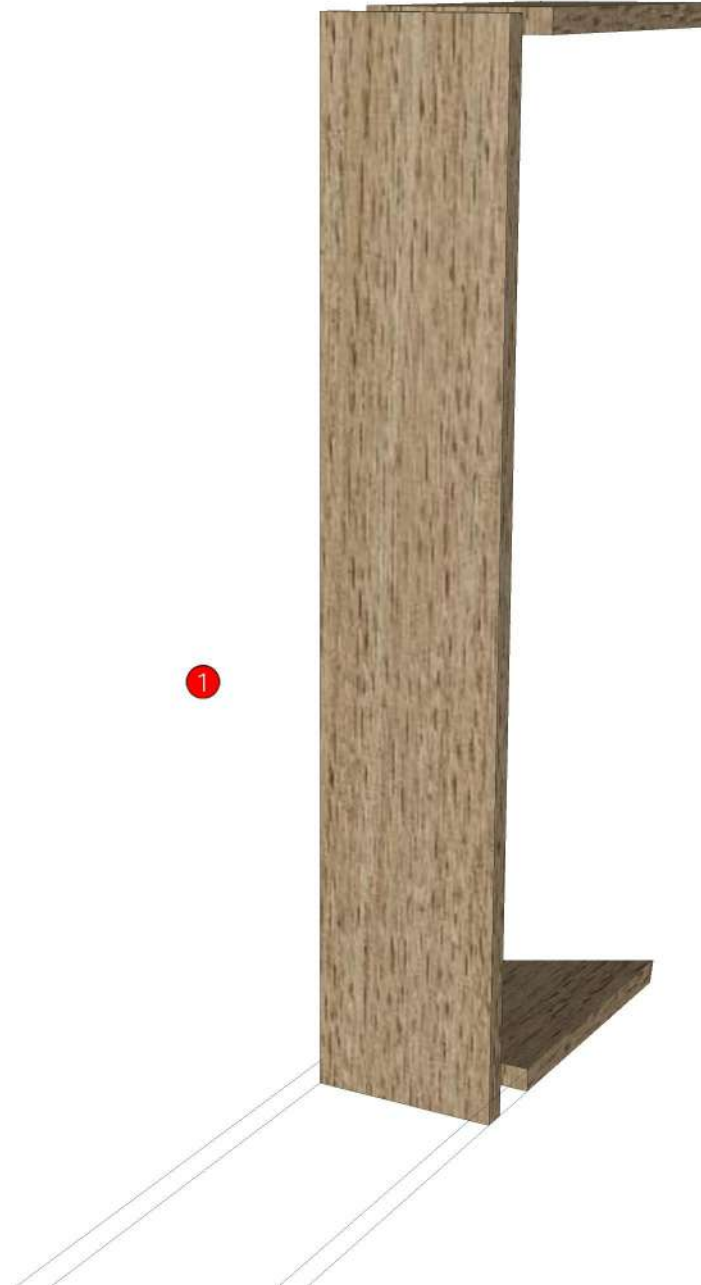

<b>Model</b>	-ADLER_DFL		
<b>Creator</b>	SUTTHI.P	<b>Name</b>	INDEX_C3D_KITCHENPAE
<b>Reviewer</b>		<b>Order</b>	O002140
<b>Approves</b>		<b>Date</b>	12/12/2024

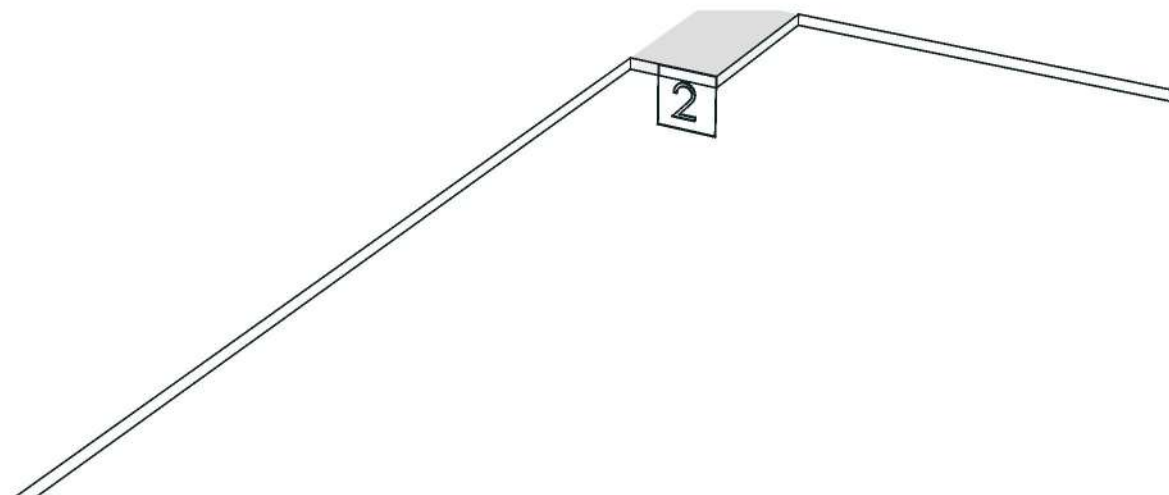

<b>Model</b>	ADLER_DFCL_1200		
<b>Creator</b>	SUTTHI.P	<b>Name</b>	INDEX_C3D_KITCHENPAE
<b>Reviewer</b>		<b>Order</b>	O002132
<b>Approves</b>		<b>Date</b>	12/12/2024

## **ADLER\_DFCL\_1200-1200X16X150**

### **Colour**

05.67=ML.WHITE LAVA MARBLE#BT5 (SUPPER MATT)

05.66=ML.WOOD OAK#BT4 (MATT WOODGRIN)

20.07=ML.WHITE #VM1012 18/18(MATT)

### **Edge**

01.380=1 ML.WHITE LAVA MARBLE BT5

01.369=1 WOOD OAK (BT4)

01.47=1 WHITE

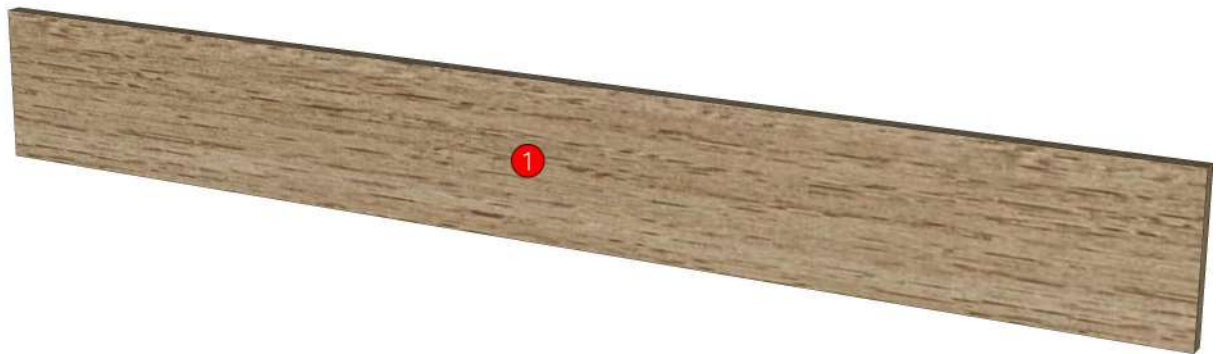

<b>Model</b>	-ADLER_DFCL_1200		
<b>Creator</b>	SUTTHI.P	<b>Name</b>	INDEX_C3D_KITCHENPAE
<b>Reviewer</b>		<b>Order</b>	0002132
<b>Approves</b>		<b>Date</b>	12/12/2024

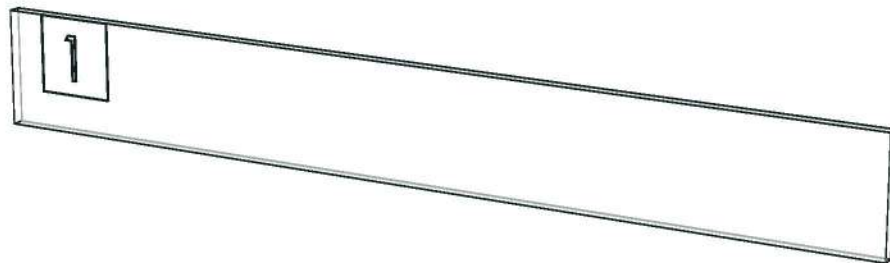

<b>Model</b>	ADLER_DFCL_2430		
<b>Creator</b>	SUTTHI.P	<b>Name</b>	INDEX_C3D_KITCHENPAE
<b>Reviewer</b>		<b>Order</b>	O002135
<b>Approves</b>		<b>Date</b>	12/12/2024

## **ADLER\_DFCL\_2430-2430X16X150**

### **Colour**

05.67=ML.WHITE LAVA MARBLE#BT5 (SUPPER MATT)

05.66=ML.WOOD OAK#BT4 (MATT WOODGRIN)

20.07=ML.WHITE #VM1012 18/18(MATT)

### **Edge**

01.380=1 ML.WHITE LAVA MARBLE BT5

01.369=1 WOOD OAK (BT4)

01.47=1 WHITE

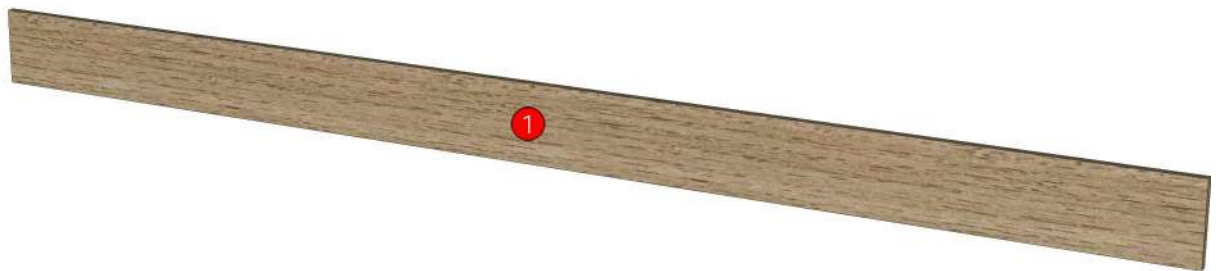

<b>Model</b>	-ADLER_DFCL_2430		
<b>Creator</b>	SUTTHI.P	<b>Name</b>	INDEX_C3D_KITCHENPAE
<b>Reviewer</b>		<b>Order</b>	0002135
<b>Approves</b>		<b>Date</b>	12/12/2024



<b>Model</b>	ADLER_DFCL_700		
<b>Creator</b>	SUTTHI.P	<b>Name</b>	INDEX_C3D_KITCHENPAE
<b>Reviewer</b>		<b>Order</b>	O002138
<b>Approves</b>		<b>Date</b>	12/12/2024

## **ADLER\_DFCL\_700-700X16X150**

### **Colour**

05.67=ML.WHITE LAVA MARBLE#BT5 (SUPPER MATT)

05.66=ML.WOOD OAK#BT4 (MATT WOODGRIN)

20.07=ML.WHITE #VM1012 18/18(MATT)

### **Edge**

01.380=1 ML.WHITE LAVA MARBLE BT5

01.369=1 WOOD OAK (BT4)

01.47=1 WHITE

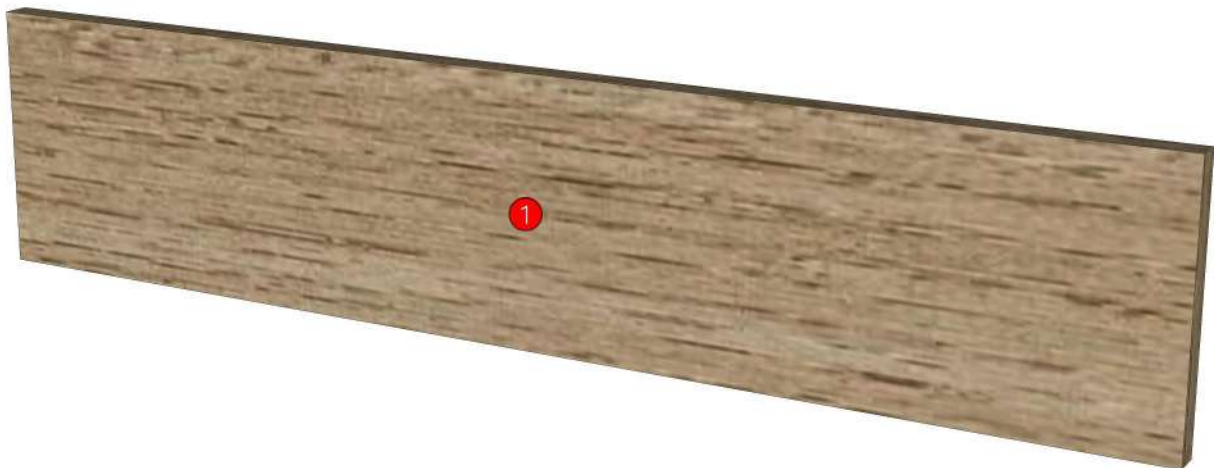

<b>Model</b>	-ADLER_DFCL_700		
<b>Creator</b>	SUTTHI.P	<b>Name</b>	INDEX_C3D_KITCHENPAE
<b>Reviewer</b>		<b>Order</b>	0002138
<b>Approves</b>		<b>Date</b>	12/12/2024

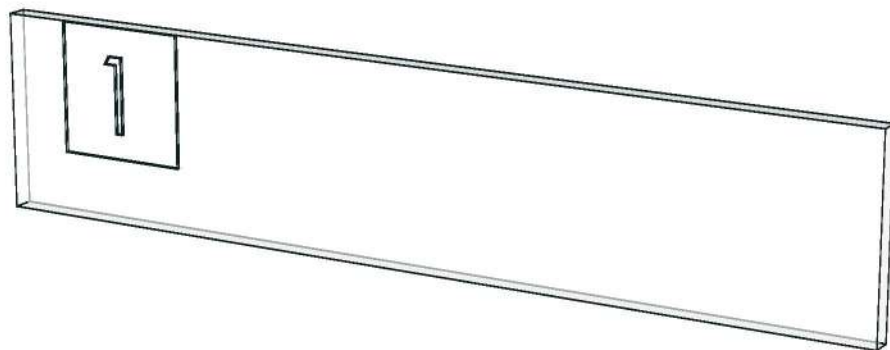

<b>Model</b>	ADLER_DFL		
<b>Creator</b>	SUTTHI.P	<b>Name</b>	INDEX_C3D_KITCHENPAE
<b>Reviewer</b>		<b>Order</b>	O002140
<b>Approves</b>		<b>Date</b>	12/12/2024

## **ADLER\_DFL-150X300X830**

### **Colour**

05.67=ML.WHITE LAVA MARBLE#BT5 (SUPPER MATT)

05.66=ML.WOOD OAK#BT4 (MATT WOODGRIN)

20.07=ML.WHITE #VM1012 18/18(MATT)

### **Edge**

01.380=1 ML.WHITE LAVA MARBLE BT5

01.369=1 WOOD OAK (BT4)

01.47=1 WHITE

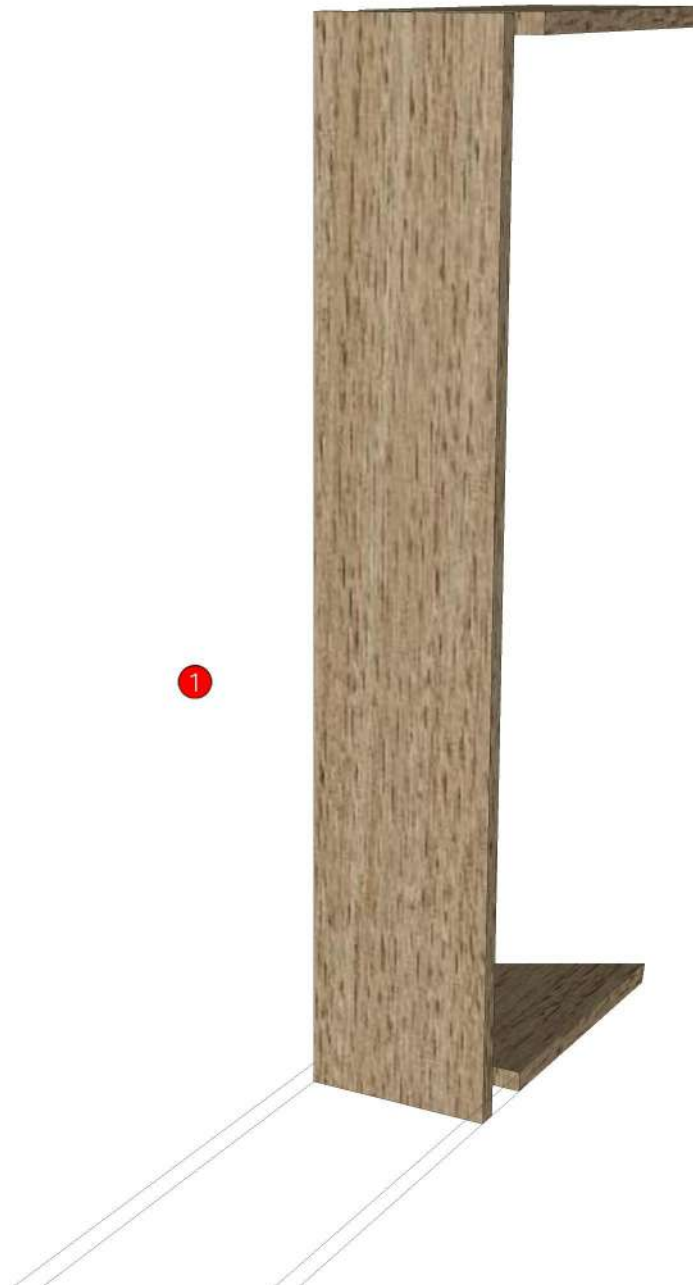

<b>Model</b>	-ADLER_DFL		
<b>Creator</b>	SUTTHI.P	<b>Name</b>	INDEX_C3D_KITCHENPAE
<b>Reviewer</b>		<b>Order</b>	O002140
<b>Approves</b>		<b>Date</b>	12/12/2024

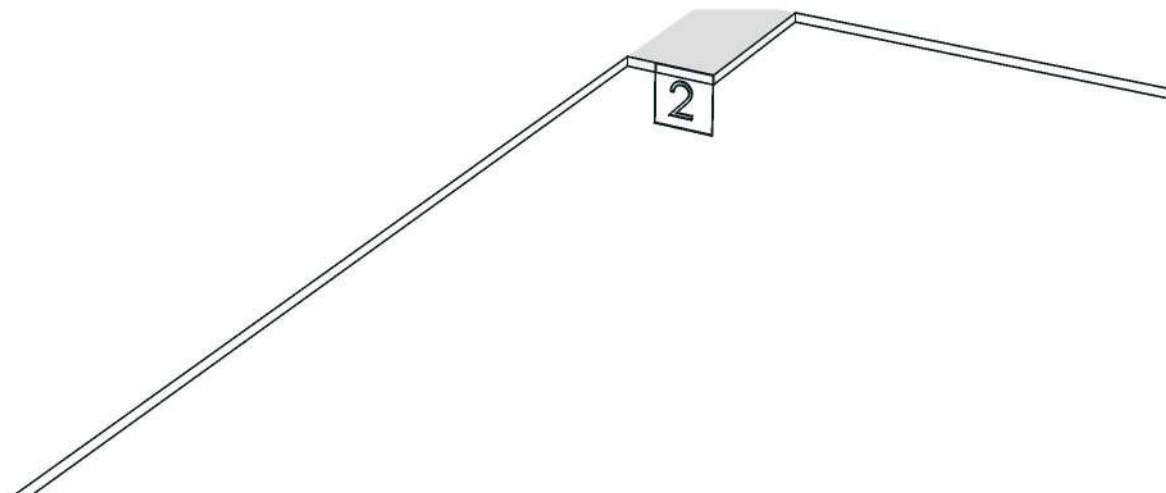

<b>Model</b>	ADLER_DFW		
<b>Creator</b>	SUTTHI.P	<b>Name</b>	INDEX_C3D_KITCHENPAE
<b>Reviewer</b>		<b>Order</b>	O002141
<b>Approves</b>		<b>Date</b>	12/12/2024

## **ADLER\_DFW-150X300X500**

### **Colour**

- 05.67=ML.WHITE LAVA MARBLE#BT5 (SUPPER MATT)
- 05.66=ML.WOOD OAK#BT4 (MATT WOODGRIN)
- 20.07=ML.WHITE #VM1012 18/18(MATT)

### **Edge**

- 01.380=1 ML.WHITE LAVA MARBLE BT5
- 01.369=1 WOOD OAK (BT4)
- 01.47=1 WHITE

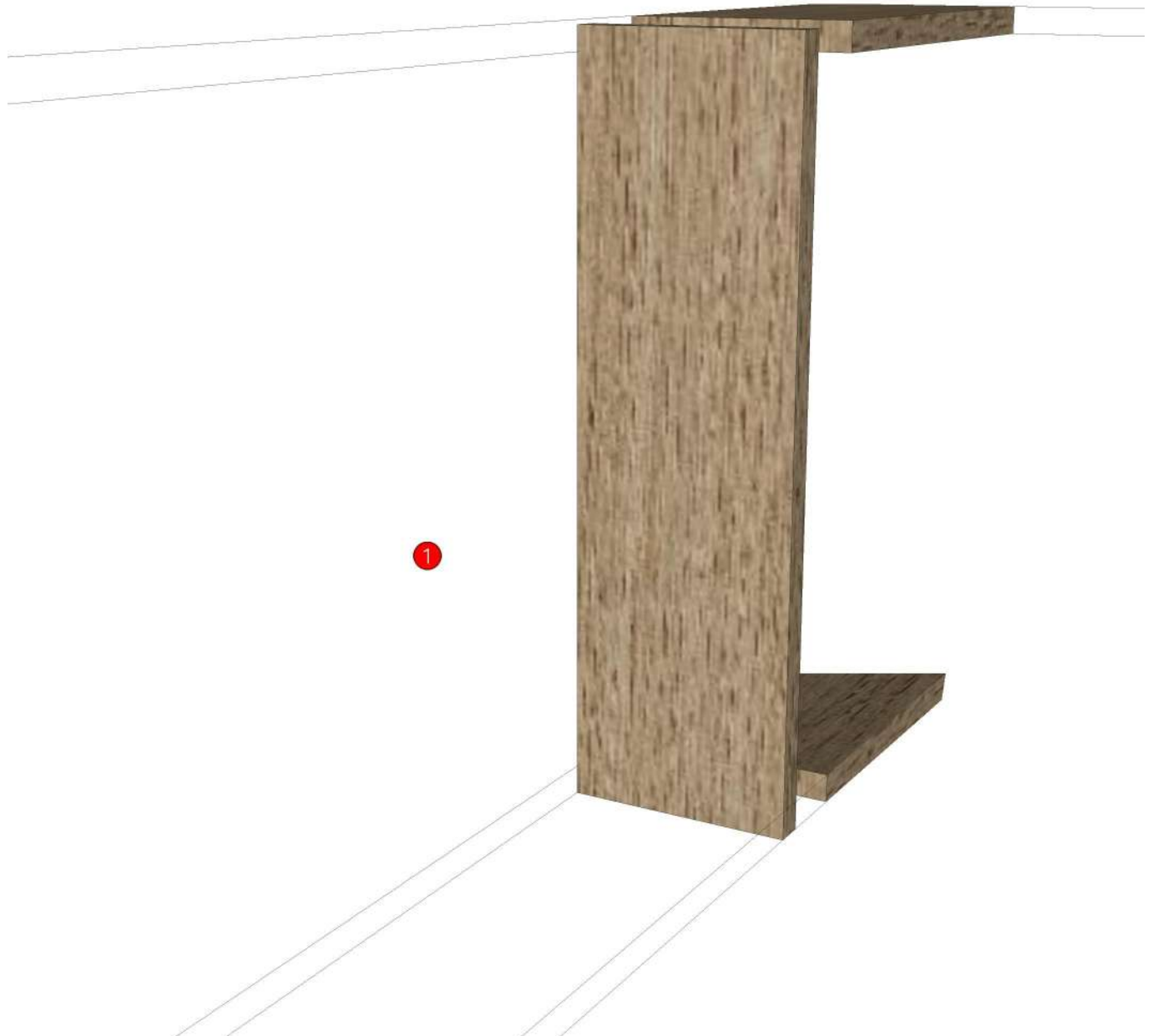

<b>Model</b>	-ADLER_DFW		
<b>Creator</b>	SUTTHI.P	<b>Name</b>	INDEX_C3D_KITCHENPAE
<b>Reviewer</b>		<b>Order</b>	O002141
<b>Approves</b>		<b>Date</b>	12/12/2024

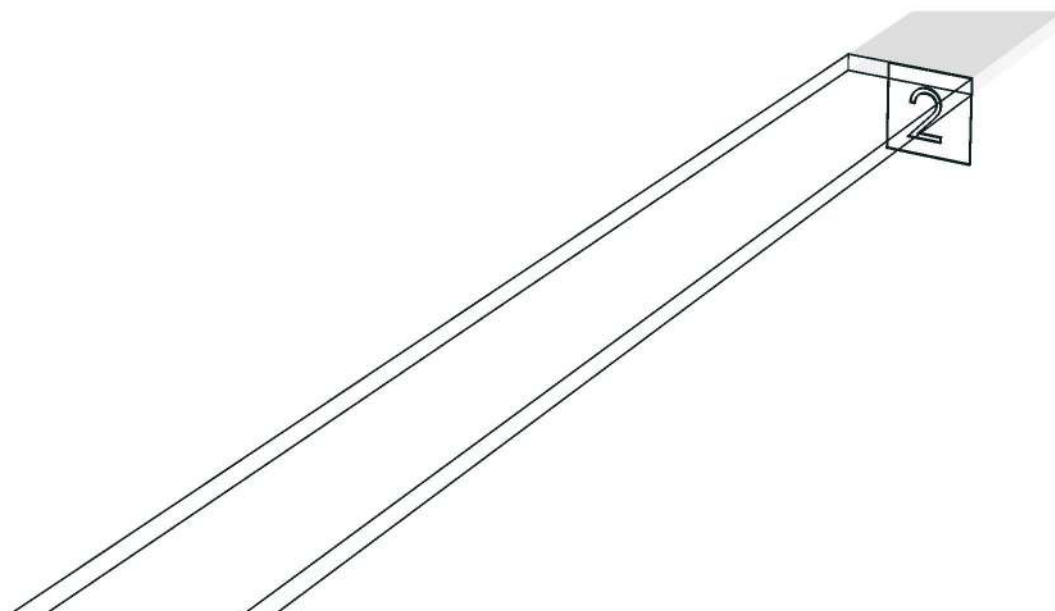

<b>Model</b>	ADLER_DL1145LS	<b>Name</b>	INDEX_C3D_KITCHENPAE
<b>Creator</b>	SUTTHI.P	<b>Order</b>	O002091
<b>Reviewer</b>		<b>Date</b>	06/12/2024
<b>Approves</b>	<i>P. SAWA I</i>		

## **ADLER\_DL1145LS-1145X300X830**

### **Colour**

05.67=ML.WHITE LAVA MARBLE#BT5 (SUPPER MATT)  
05.66=ML.WOOD OAK#BT4 (MATT WOODGRIN)  
20.07=ML.WHITE #VM1012 18/18(MATT)

### **Edge**

01.380=1 ML.WHITE LAVA MARBLE BT5  
01.369=1 WOOD OAK (BT4)  
01.47=1 WHITE

K101L 160149975

<b>R&amp;D REVIEW</b>	
<input checked="" type="checkbox"/>	DWG.Customer
<input type="checkbox"/>	Work Report
<input type="checkbox"/>	Function
<input type="checkbox"/>	สินค้าตรงตัวอย่าง
ผู้ทบทวน <u>P.SAWA I</u>	
____/____/____	

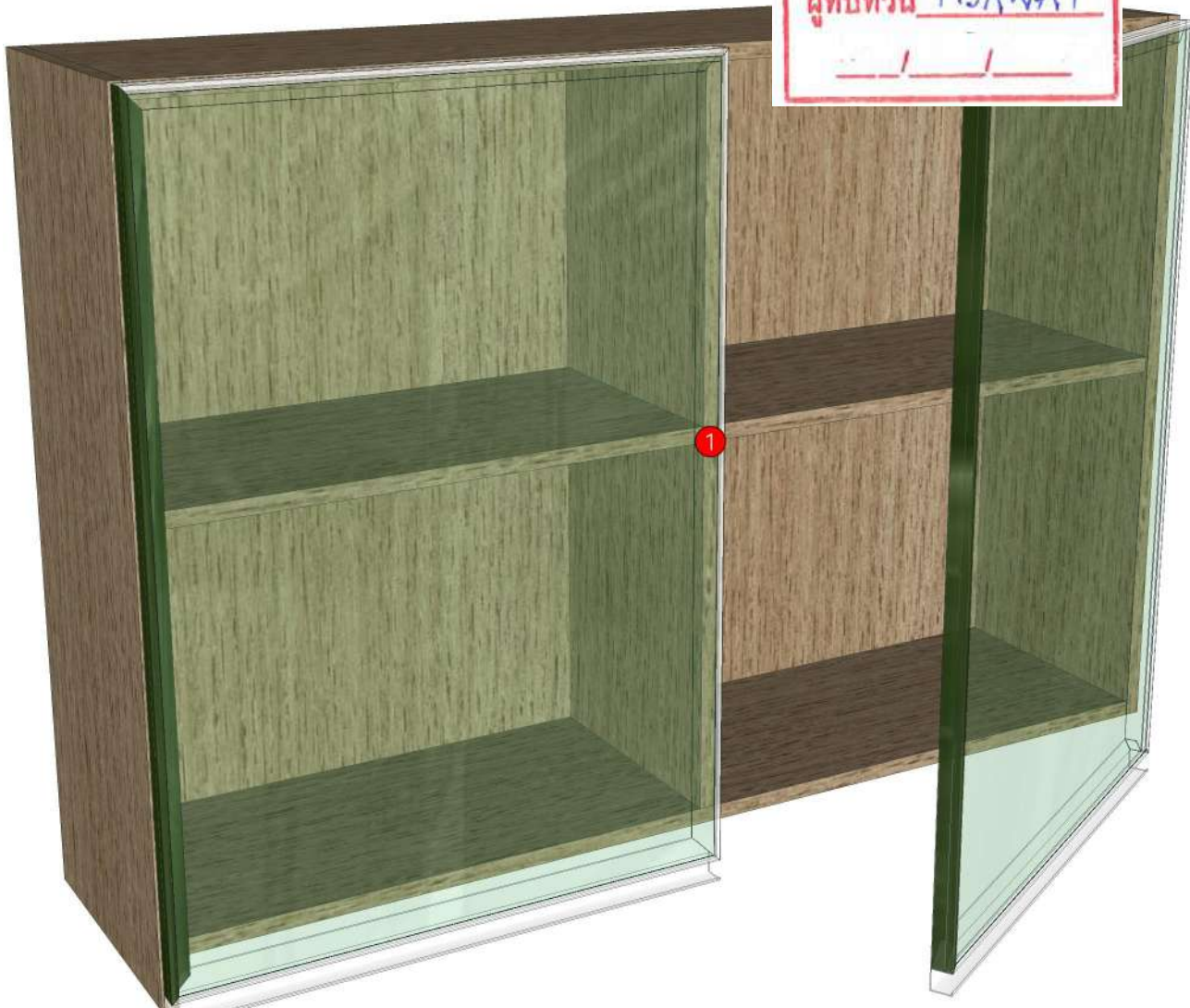

<b>Model</b>	-ADLER_DL1145LS	<b>Name</b>	INDEX_C3D_KITCHENPAE
<b>Creator</b>	SUTTHI.P	<b>Order</b>	O002091
<b>Reviewer</b>		<b>Date</b>	06/12/2024
<b>Approves</b>	<i>P. SAWA</i>		

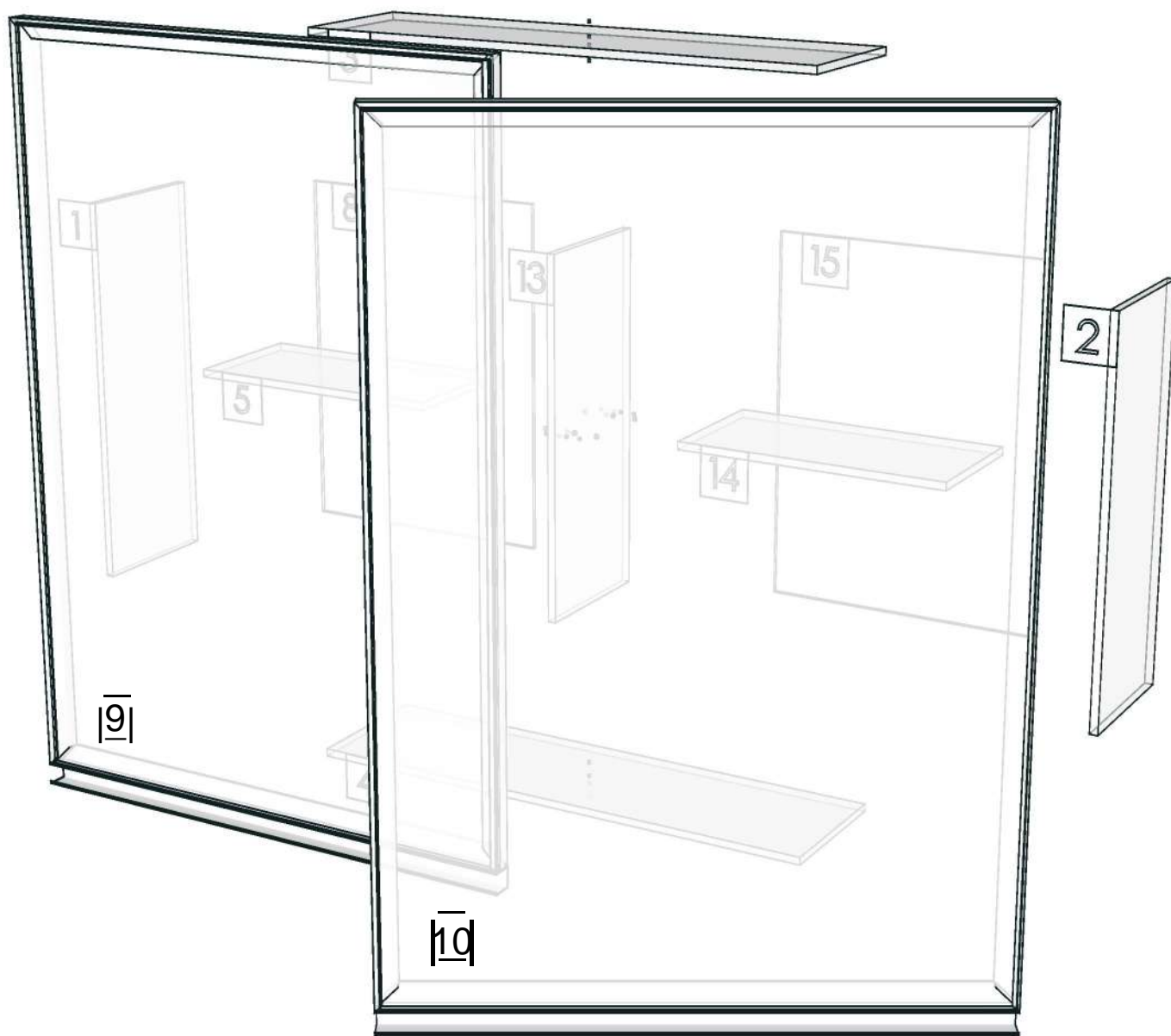

<b>Model</b>	ADLER_DL60HL	<b>Name</b>	INDEX_C3D_KITCHENPAE
<b>Creator</b>	SUTTHI.P	<b>Order</b>	O002106
<b>Reviewer</b>		<b>Date</b>	09/12/2024
<b>Approves</b>	<i>P.SAWA</i>		

## **ADLER\_DL60HL-600X300X785**

### **Colour**

05.67=ML.WHITE LAVA MARBLE#BT5 (SUPPER MATT)  
05.66=ML.WOOD OAK#BT4 (MATT WOODGRIN)  
20.07=ML.WHITE #VM1012 18/18(MATT)

### **Edge**

01.380=1 ML.WHITE LAVA MARBLE BT5  
01.369=1 WOOD OAK (BT4)  
01.47=1 WHITE

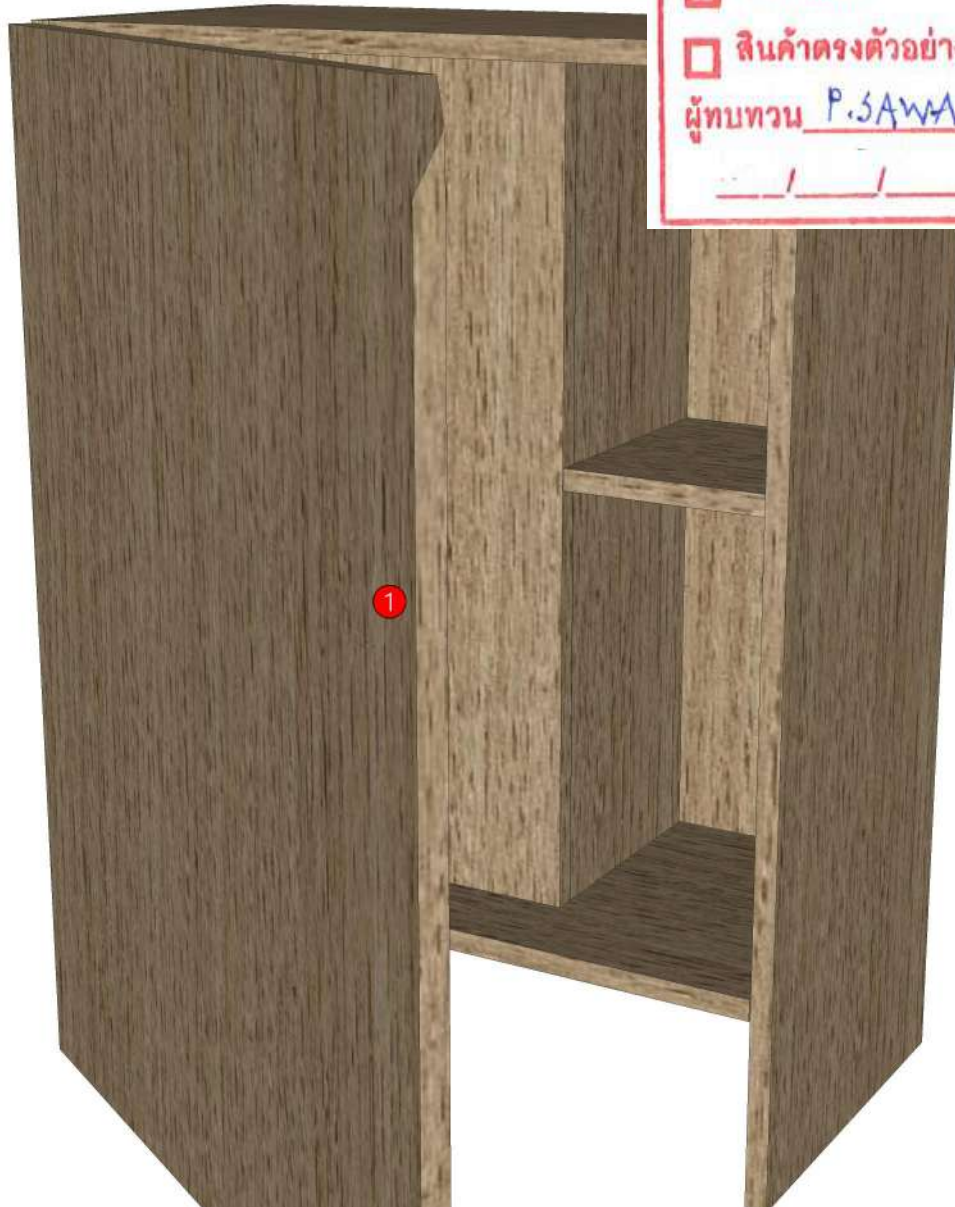

**R&D REVIEW**

- DWG.Customer
- Work Report
- Function
- สินค้าตรงตัวอย่าง

ผู้ทบทวน P.SAWA

\_\_\_\_/\_\_\_\_/\_\_\_\_

<b>Model</b>	-ADLER_DL60HL		
<b>Creator</b>	SUTTHI.P	<b>Name</b>	INDEX_C3D_KITCHENPAE
<b>Reviewer</b>		<b>Order</b>	O002106
<b>Approves</b>	<i>P. SAWA</i>	<b>Date</b>	09/12/2024

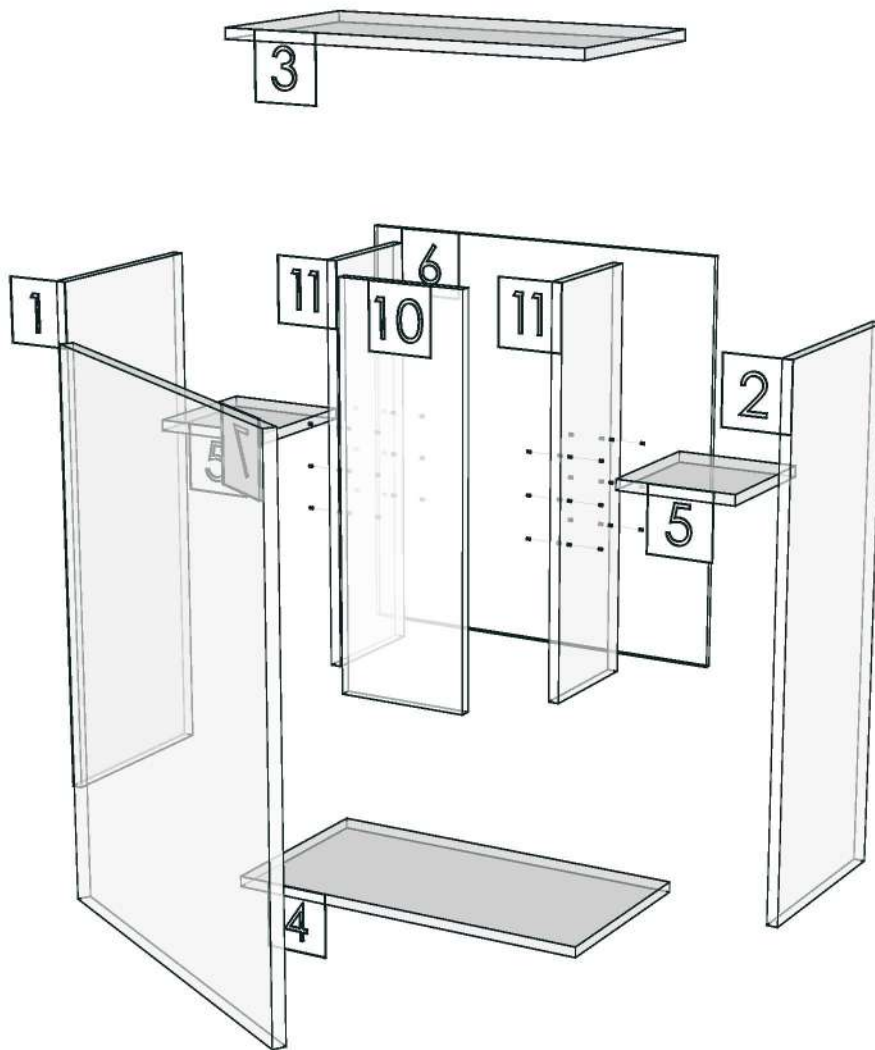

<b>Model</b>	ADLER_DL60R	<b>Name</b>	INDEX_C3D_KITCHENPAE
<b>Creator</b>	SUTTHI.P	<b>Order</b>	O002096
<b>Reviewer</b>		<b>Date</b>	06/12/2024
<b>Approves</b>			

## **ADLER\_DL60R-600X300X830**

### **Colour**

05.67=ML.WHITE LAVA MARBLE#BT5 (SUPPER MATT)

05.66=ML.WOOD OAK#BT4 (MATT WOODGRIN)

20.07=ML.WHITE #VM1012 18/18(MATT)

### **Edge**

01.380=1 ML.WHITE LAVA MARBLE BT5

01.369=1 WOOD OAK (BT4)

01.47=1 WHITE



<b>Model</b>	-ADLER_DL60R		
<b>Creator</b>	SUTTHI.P	<b>Name</b>	INDEX_C3D_KITCHENPAE
<b>Reviewer</b>		<b>Order</b>	O002096
<b>Approves</b>		<b>Date</b>	06/12/2024

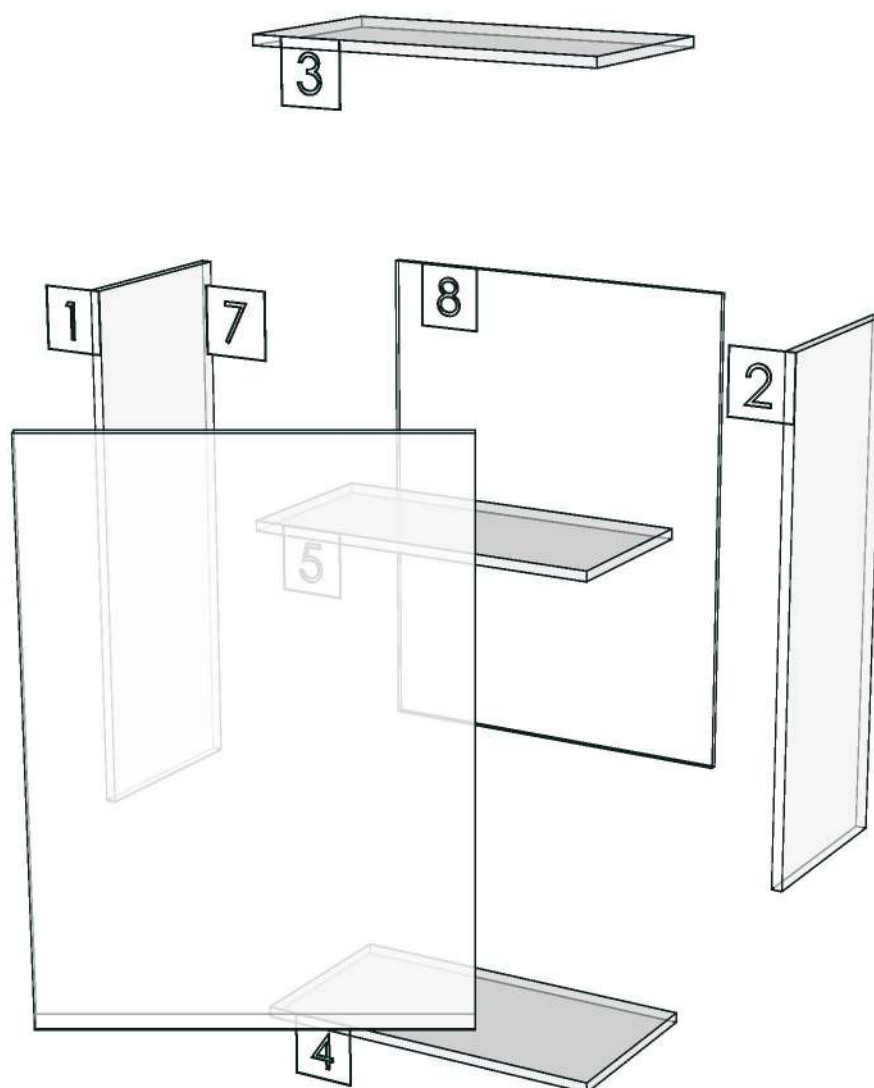

<b>Model</b>	ADLER_DPLT_2430		
<b>Creator</b>	SUTTHI.P	<b>Name</b>	INDEX_C3D_KITCHENPAE
<b>Reviewer</b>		<b>Order</b>	O002124
<b>Approves</b>		<b>Date</b>	12/12/2024

## **ADLER\_DPLT\_2430-2430X9X100**

### **Colour**

05.67=ML.WHITE LAVA MARBLE#BT5 (SUPPER MATT)

05.66=ML.WOOD OAK#BT4 (MATT WOODGRIN)

20.07=ML.WHITE #VM1012 18/18(MATT)

### **Edge**

01.380=1 ML.WHITE LAVA MARBLE BT5

01.369=1 WOOD OAK (BT4)

01.47=1 WHITE

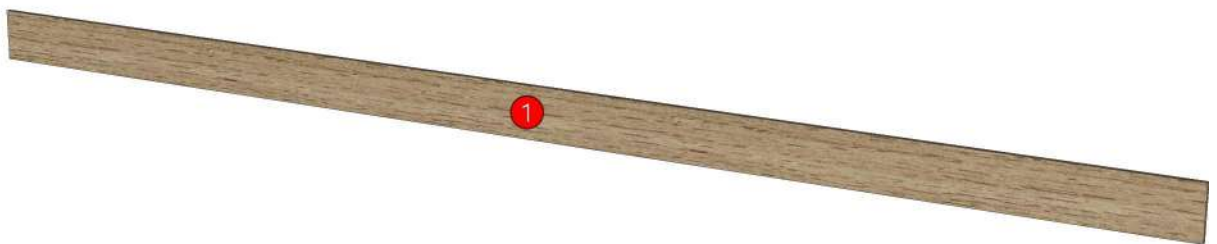

<b>Model</b>	-ADLER_DPLT_2430		
<b>Creator</b>	SUTTHI.P	<b>Name</b>	INDEX_C3D_KITCHENPAE
<b>Reviewer</b>		<b>Order</b>	O002124
<b>Approves</b>		<b>Date</b>	12/12/2024



<b>Model</b>	ADLER_DPLT_567G		
<b>Creator</b>	SUTTHI.P	<b>Name</b>	INDEX_C3D_KITCHENPAE
<b>Reviewer</b>		<b>Order</b>	O002125
<b>Approves</b>		<b>Date</b>	12/12/2024

## **ADLER\_DPLT\_567G-567X9X100**

### **Colour**

05.67=ML.WHITE LAVA MARBLE#BT5 (SUPPER MATT)

05.66=ML.WOOD OAK#BT4 (MATT WOODGRIN)

20.07=ML.WHITE #VM1012 18/18(MATT)

### **Edge**

01.380=1 ML.WHITE LAVA MARBLE BT5

01.369=1 WOOD OAK (BT4)

01.47=1 WHITE

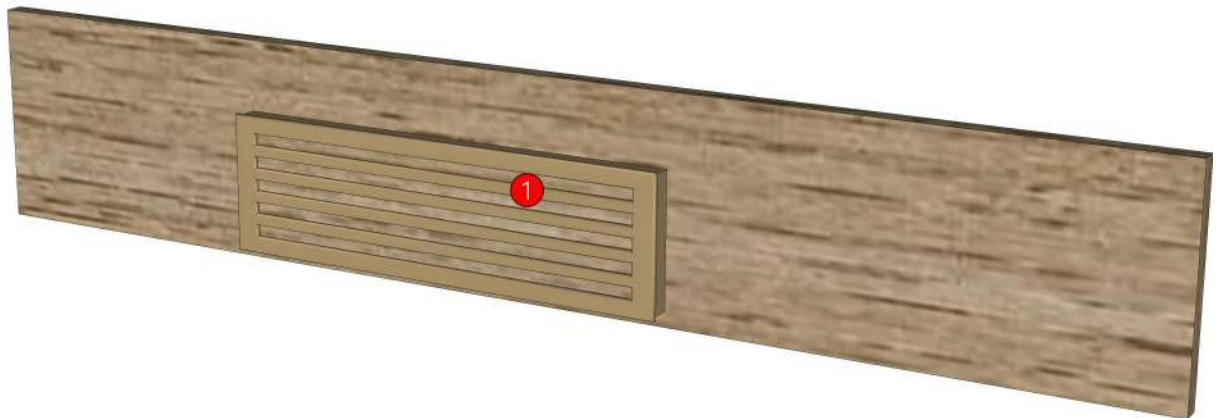

<b>Model</b>	-ADLER_DPLT_567G		
<b>Creator</b>	SUTTHI.P	<b>Name</b>	INDEX_C3D_KITCHENPAE
<b>Reviewer</b>		<b>Order</b>	0002125
<b>Approves</b>		<b>Date</b>	12/12/2024

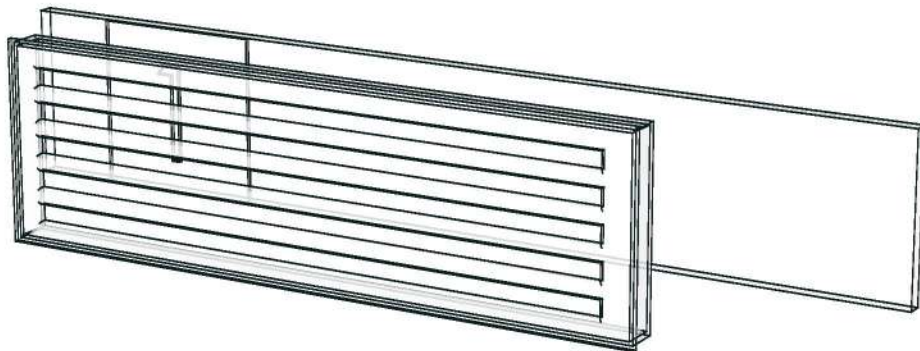

<b>Model</b>	ADLER_DT60L	<b>Name</b>	INDEX_C3D_KITCHENPAE
<b>Creator</b>	SUTTHI.P	<b>Order</b>	O002109
<b>Reviewer</b>		<b>Date</b>	10/12/2024
<b>Approves</b>	<i>P.SAWA</i>		

## **ADLER\_DT60L-600X600X2400**

### **Colour**

05.67=ML.WHITE LAVA MARBLE#BT5 (SUPPER MATT)  
05.66=ML.WOOD OAK#BT4 (MATT WOODGRIN)  
20.07=ML.WHITE #VM1012 18/18(MATT)

### **Edge**

01.380=1 ML.WHITE LAVA MARBLE BT5  
01.369=1 WOOD OAK (BT4)  
01.47=1 WHITE

K101R 160149992

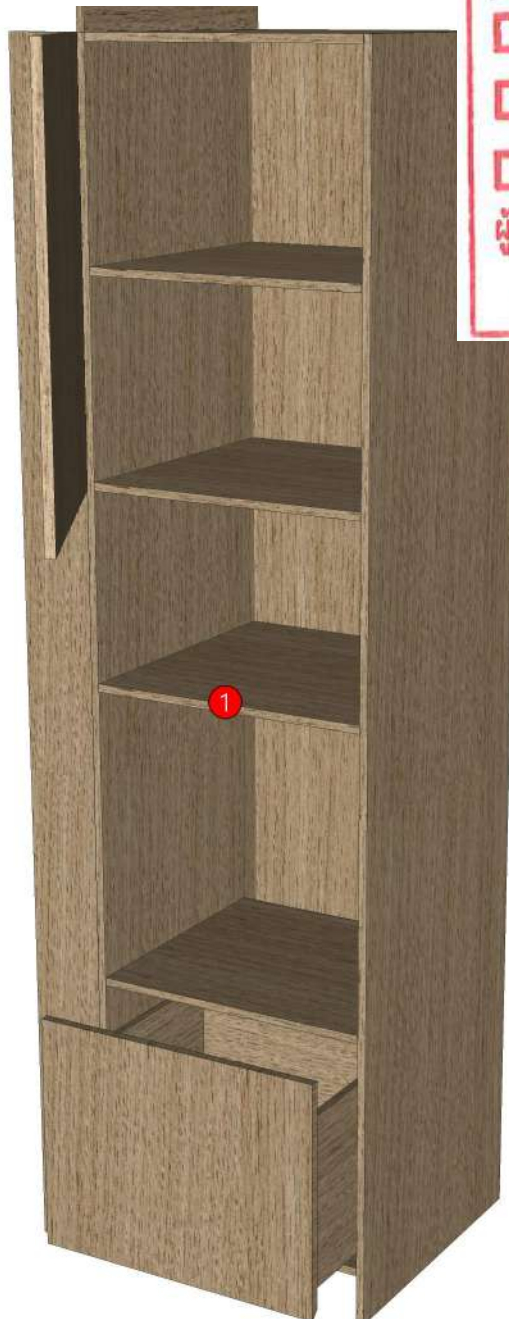

<b>R&amp;D REVIEW</b>	
<input checked="" type="checkbox"/>	DWG.Customer
<input type="checkbox"/>	Work Report
<input type="checkbox"/>	Function
<input type="checkbox"/>	สินค้าตรงตัวอย่าง
ผู้ทบทวน <u>P.SAWA</u>	
____/____/____	

<b>Model</b>	-ADLER_DT60L		
<b>Creator</b>	SUTTHI.P	<b>Name</b>	INDEX_C3D_KITCHENPAE
<b>Reviewer</b>		<b>Order</b>	O002109
<b>Approves</b>	<i>P. SAWA</i>	<b>Date</b>	10/12/2024

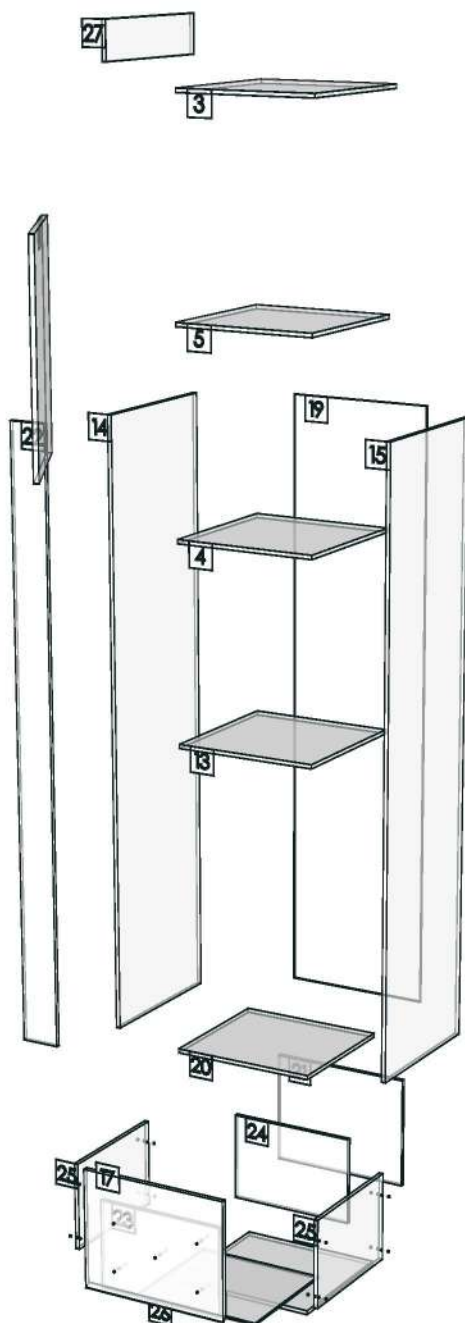

<b>Model</b>	ADLER_DT60R	<b>Name</b>	INDEX_C3D_KITCHENPAE
<b>Creator</b>	SUTTHI.P	<b>Order</b>	O002110
<b>Reviewer</b>		<b>Date</b>	10/12/2024
<b>Approves</b>	<i>P.SAWA</i>		

## ADLER\_DT60R-600X600X2400

### Colour

05.67=ML.WHITE LAVA MARBLE#BT5 (SUPPER MATT)  
05.66=ML.WOOD OAK#BT4 (MATT WOODGRIN)  
20.07=ML.WHITE #VM1012 18/18(MATT)

### Edge

01.380=1 ML.WHITE LAVA MARBLE BT5  
01.369=1 WOOD OAK (BT4)  
01.47=1 WHITE

K101L 160149975

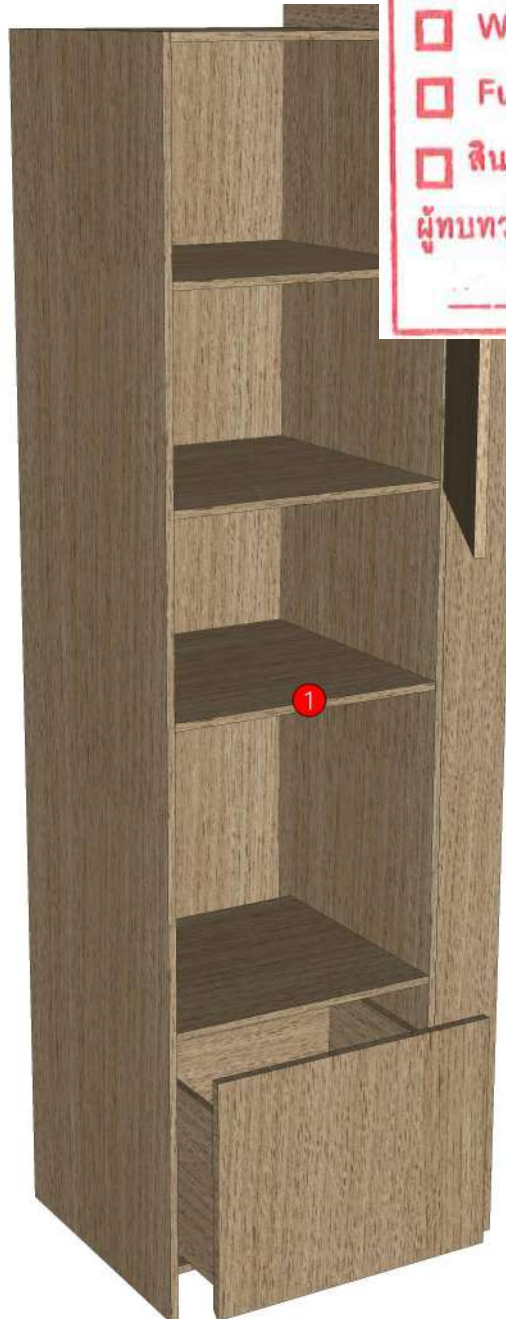

<b>R&amp;D REVIEW</b>	
<input checked="" type="checkbox"/>	DWG.Customer
<input type="checkbox"/>	Work Report
<input type="checkbox"/>	Function
<input type="checkbox"/>	สินค้าตรงตัวอย่าง
ผู้ทบทวน <u>P.SAWA</u>	
____/____/____	

<b>Model</b>	-ADLER_DT60R		
<b>Creator</b>	SUTTHI.P	<b>Name</b>	INDEX_C3D_KITCHENPAE
<b>Reviewer</b>		<b>Order</b>	O002110
<b>Approves</b>	<i>P. SAWA</i>	<b>Date</b>	10/12/2024

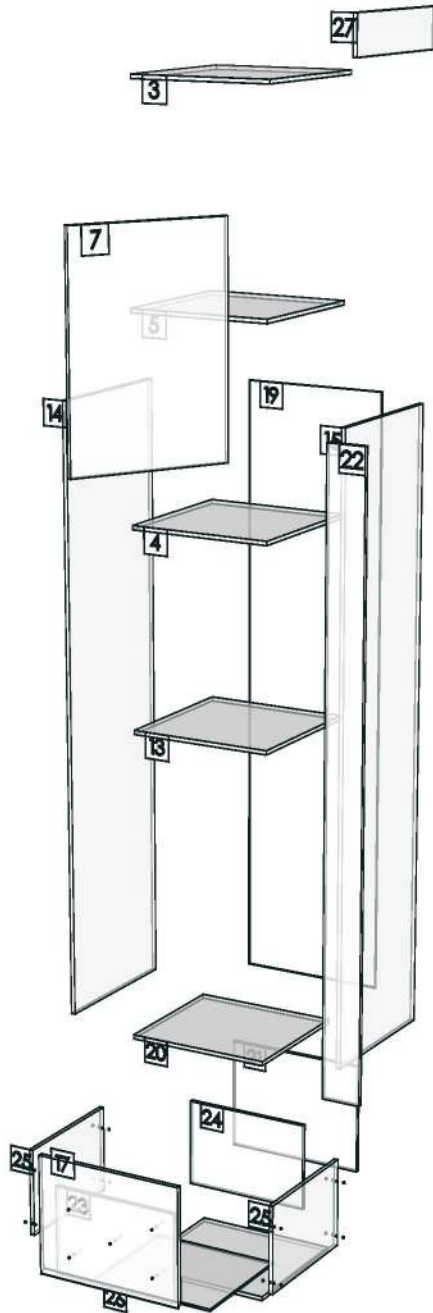

<b>Model</b>	ADLER_DUT_2400		
<b>Creator</b>	SUTTHI.P	<b>Name</b>	INDEX_C3D_KITCHENPAE
<b>Reviewer</b>		<b>Order</b>	O002117
<b>Approves</b>		<b>Date</b>	10/12/2024

## **ADLER\_DUT\_2400-2400X60X25**

### **Colour**

05.67=ML.WHITE LAVA MARBLE#BT5 (SUPPER MATT)

05.66=ML.WOOD OAK#BT4 (MATT WOODGRIN)

20.07=ML.WHITE #VM1012 18/18(MATT)

### **Edge**

01.380=1 ML.WHITE LAVA MARBLE BT5

01.369=1 WOOD OAK (BT4)

01.47=1 WHITE

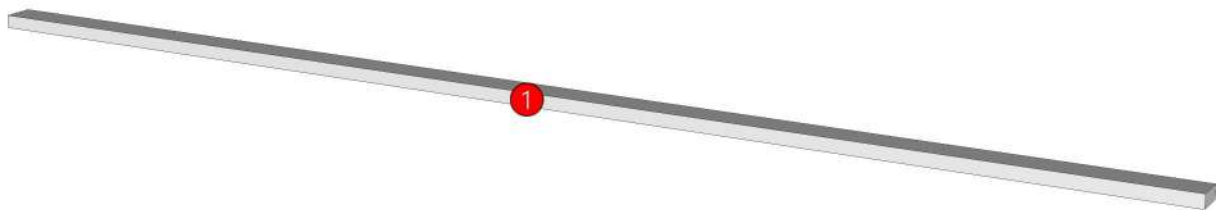

<b>Model</b>	-ADLER_DUT_2400		
<b>Creator</b>	SUTTHI.P	<b>Name</b>	INDEX_C3D_KITCHENPAE
<b>Reviewer</b>		<b>Order</b>	O002117
<b>Approves</b>		<b>Date</b>	10/12/2024



<b>Model</b>	ADLER_DUT_500		
<b>Creator</b>	SUTTHI.P	<b>Name</b>	INDEX_C3D_KITCHENPAE
<b>Reviewer</b>		<b>Order</b>	O002118
<b>Approves</b>		<b>Date</b>	11/12/2024

## **ADLER\_DUT\_500-500X60X25**

### **Colour**

05.67=ML.WHITE LAVA MARBLE#BT5 (SUPPER MATT)

05.66=ML.WOOD OAK#BT4 (MATT WOODGRIN)

20.07=ML.WHITE #VM1012 18/18(MATT)

### **Edge**

01.380=1 ML.WHITE LAVA MARBLE BT5

01.369=1 WOOD OAK (BT4)

01.47=1 WHITE

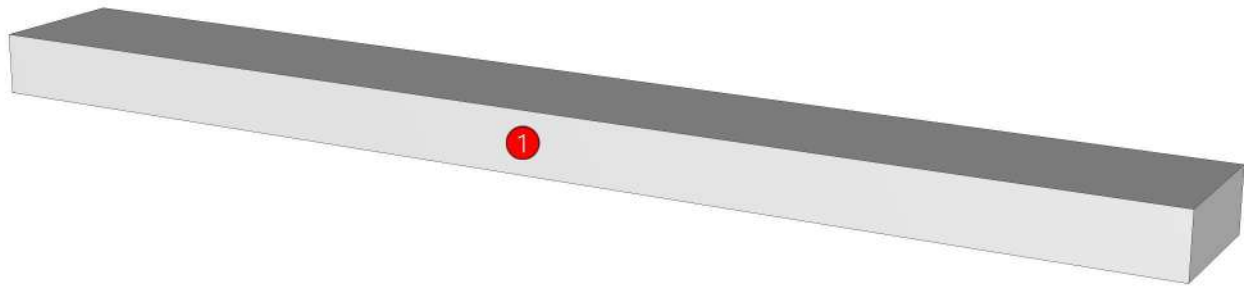

<b>Model</b>	-ADLER_DUT_500		
<b>Creator</b>	SUTTHI.P	<b>Name</b>	INDEX_C3D_KITCHENPAE
<b>Reviewer</b>		<b>Order</b>	0002118
<b>Approves</b>		<b>Date</b>	11/12/2024

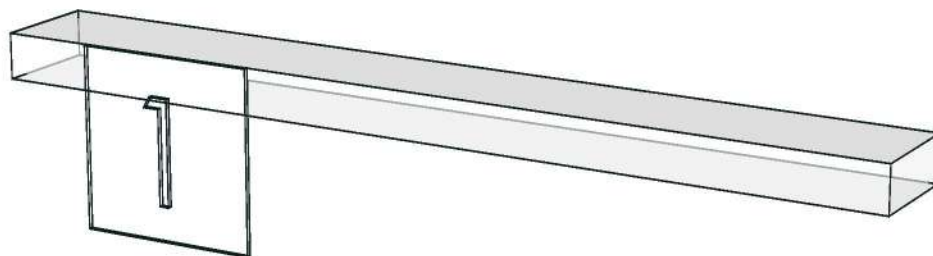

<b>Model</b>	ADLER_DW100		
<b>Creator</b>	SUTTHI.P	<b>Name</b>	INDEX_C3D_KITCHENPAE
<b>Reviewer</b>		<b>Order</b>	O002097
<b>Approves</b>		<b>Date</b>	06/12/2024

## **ADLER\_DW100-1000X300X500**

### **Colour**

05.67=ML.WHITE LAVA MARBLE#BT5 (SUPPER MATT)

05.66=ML.WOOD OAK#BT4 (MATT WOODGRIN)

20.07=ML.WHITE #VM1012 18/18(MATT)

### **Edge**

01.380=1 ML.WHITE LAVA MARBLE BT5

01.369=1 WOOD OAK (BT4)

01.47=1 WHITE



<b>Model</b>	-ADLER_DW100		
<b>Creator</b>	SUTTHI.P	<b>Name</b>	INDEX_C3D_KITCHENPAE
<b>Reviewer</b>		<b>Order</b>	O002097
<b>Approves</b>		<b>Date</b>	06/12/2024

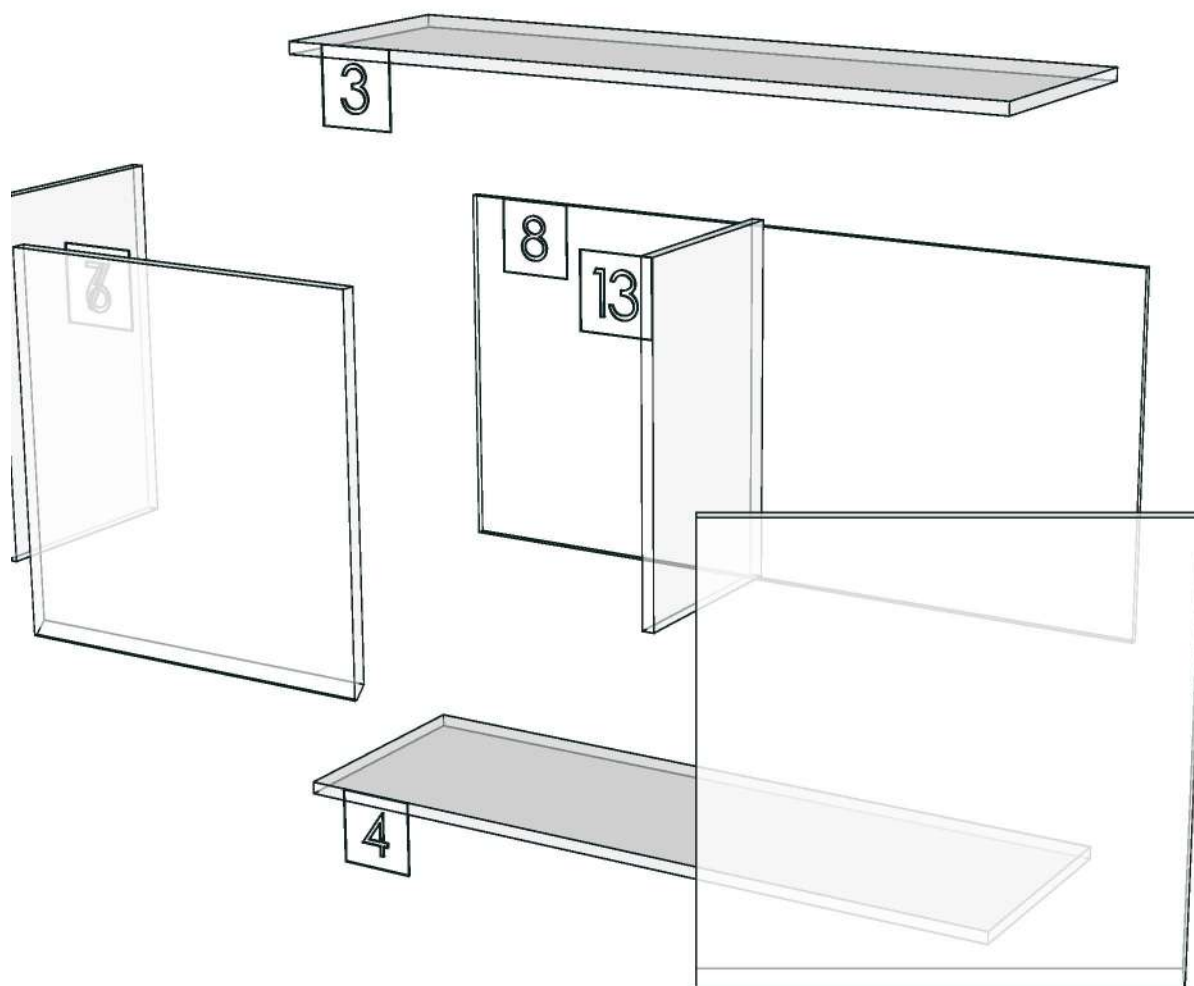

<b>Model</b>	ADLER_D_BOX1200		
<b>Creator</b>	SUTTHI.P	<b>Name</b>	INDEX_C3D_KITCHENPAE
<b>Reviewer</b>		<b>Order</b>	O002142
<b>Approves</b>		<b>Date</b>	12/12/2024

## **ADLER\_D\_BOX1200-1200X350X600**

### **Colour**

05.67=ML.WHITE LAVA MARBLE#BT5 (SUPPER MATT)

05.66=ML.WOOD OAK#BT4 (MATT WOODGRIN)

20.07=ML.WHITE #VM1012 18/18(MATT)

### **Edge**

01.380=1 ML.WHITE LAVA MARBLE BT5

01.369=1 WOOD OAK (BT4)

01.47=1 WHITE



1



<b>Model</b>	-ADLER_D_BOX1200		
<b>Creator</b>	SUTTHI.P	<b>Name</b>	INDEX_C3D_KITCHENPAE
<b>Reviewer</b>		<b>Order</b>	O002142
<b>Approves</b>		<b>Date</b>	12/12/2024

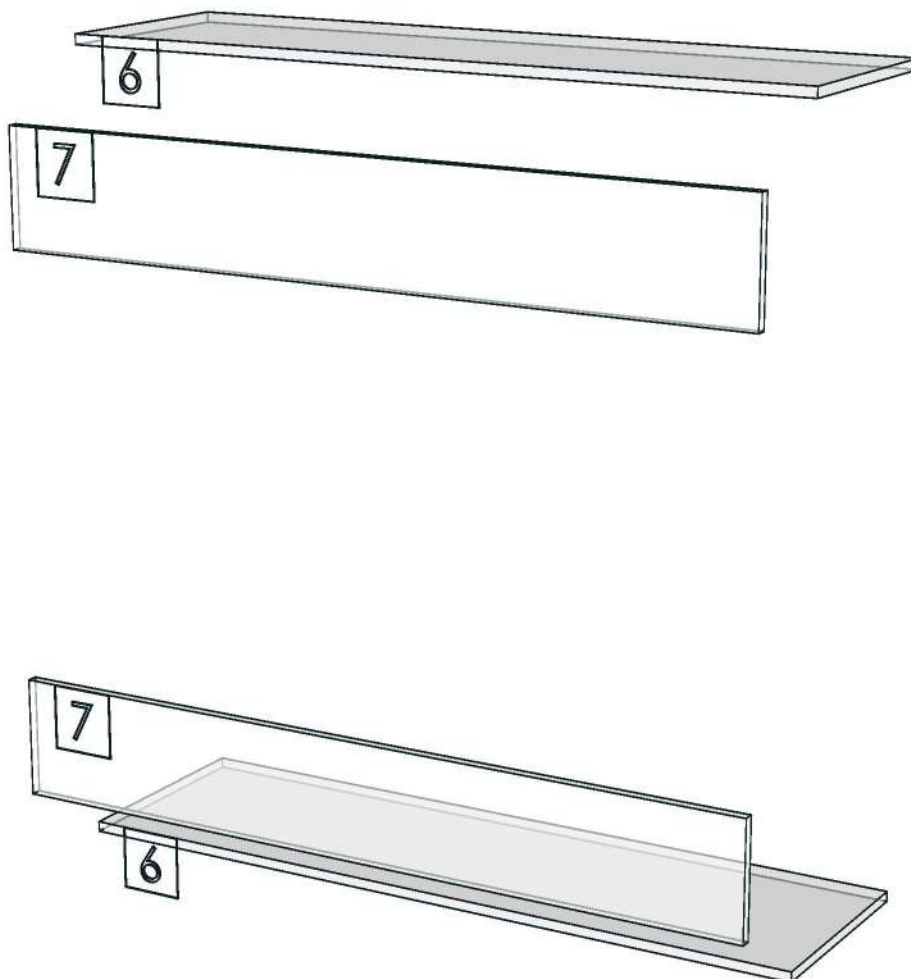

<b>Model</b>	ADLER_LED_1713R		
<b>Creator</b>	SUTTHI.P	<b>Name</b>	INDEX_C3D_KITCHENPAE
<b>Reviewer</b>		<b>Order</b>	O002102
<b>Approves</b>		<b>Date</b>	09/12/2024

## **ADLER\_LED\_1713R-1713X300X50**

### **Colour**

05.67=ML.WHITE LAVA MARBLE#BT5 (SUPPER MATT)

05.66=ML.WOOD OAK#BT4 (MATT WOODGRIN)

20.07=ML.WHITE #VM1012 18/18(MATT)

### **Edge**

01.380=1 ML.WHITE LAVA MARBLE BT5

01.369=1 WOOD OAK (BT4)

01.47=1 WHITE

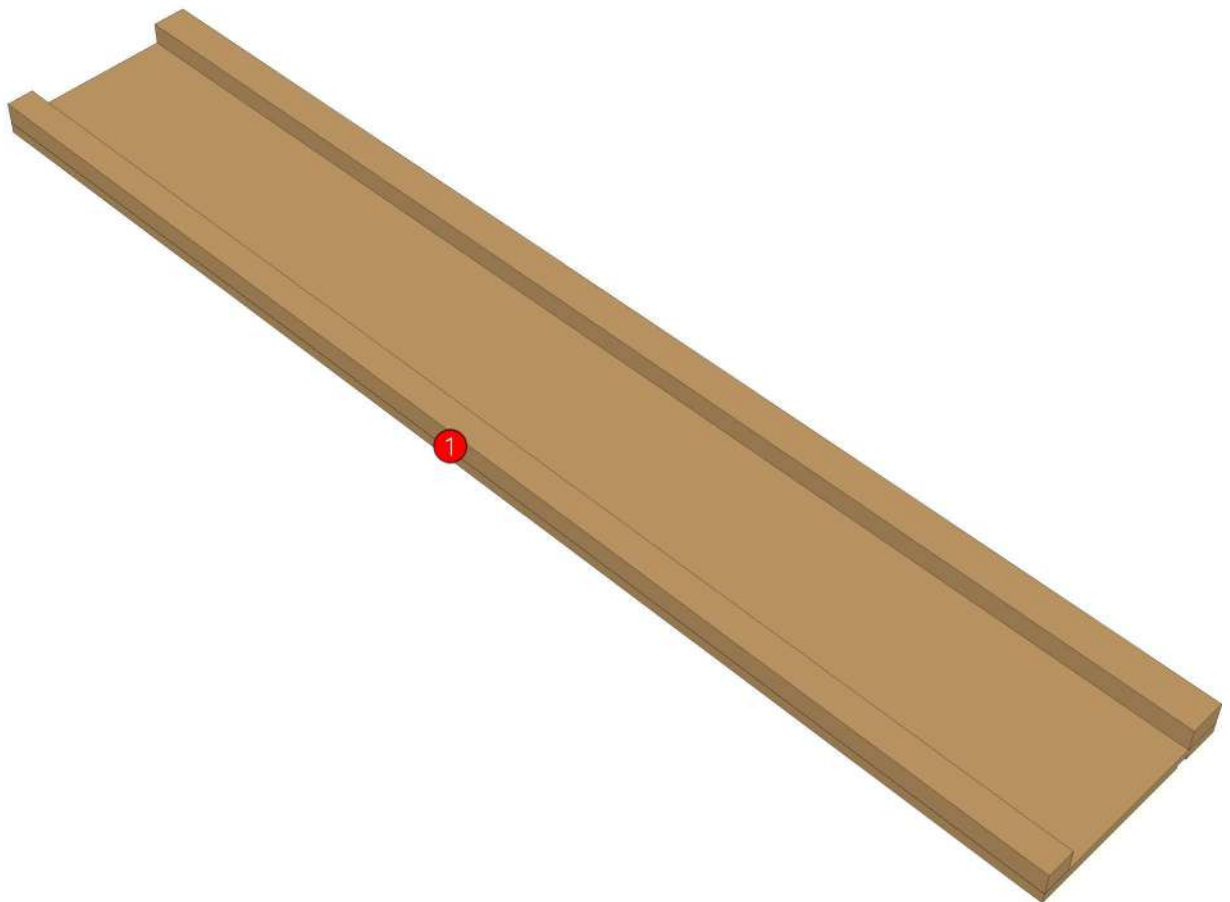

<b>Model</b>	-ADLER_LED_1713R		
<b>Creator</b>	SUTTHI.P	<b>Name</b>	INDEX_C3D_KITCHENPAE
<b>Reviewer</b>		<b>Order</b>	O002102
<b>Approves</b>		<b>Date</b>	09/12/2024

