

Model	1PLUS_CRM_TOP_103R		
Creator	CHALEAMPHON	.BCP Name	INDEX_C3D_KITCHEN2
Reviewer		Order	H001483
Approves		Date	23/01/2025

1PLUS_CRM_TOP_103R-1402X600X38

Colour

04.26=LAMINATE HPL #8117-S

04.10=LAMINATE HPL # TD9201PL

30.01=ML WHITE VM1012 18/18 (WET PROTECT)

30.02=NO SURFACE DAMP PROOF WOOD 18/18 (WET PROTECT)

Edge

04.01=0.8 HPL

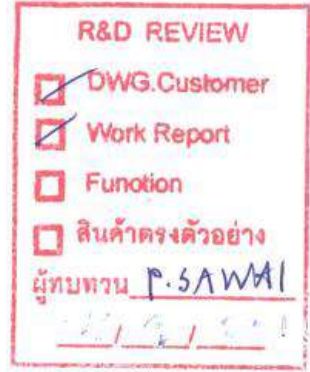

K103R-160149351

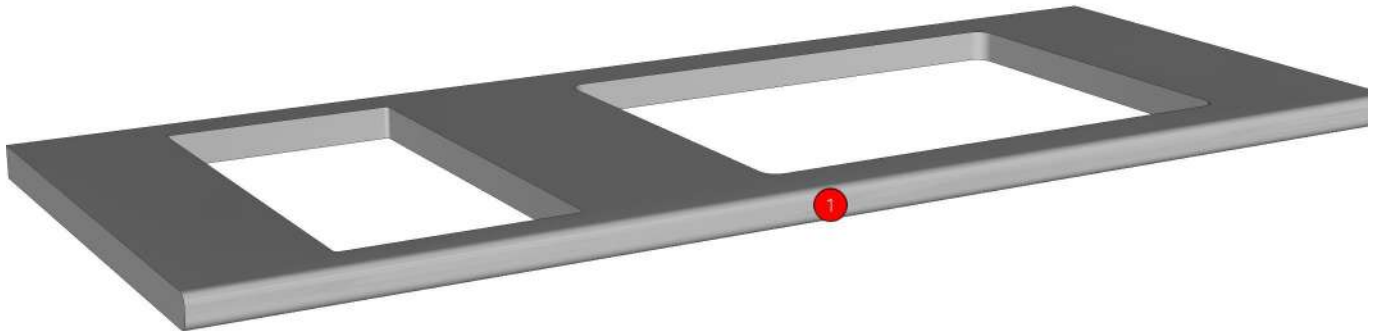

Model	1PLUS_CRM_TOP_103R		
Creator	CHALEAMPHON	.BCP Name	INDEX_C3D_KITCHEN2
Reviewer		Order	H001483
Approves		Date	23/01/2025

No.	Article No.	Description	Mat	Dimension	Cutting Size	Typeology	Skin
0	1PLUS_CRM_TOP_103R			1402x38x600			
	1PLUS_CRM_TOP_103R-01A	TOP ASSEMBLE COMPLETED	PB-ST	38x600x1402	38X600X1401.2;L0:W1	182000_STR=04.26_EDG=HPL-.8	2
	1PLUS_CRM_TOP_103R-01AA	TOP	PB-ST	18x600x1412	18X600X1412;NO EDGE	182001_STR=04.10_EDG=-	1
	1PLUS_CRM_TOP_103R-01AB	DOUBLE TOP	PB-ST	18x50x1412	18X50X1412;NO EDGE	182002_STR=30.02_EDG=-	
	1PLUS_CRM_TOP_103R-01B	DOUBLE FRONT BACK	PB-ST	18x50x1192	18X50X1192;NO EDGE	182003_STR=30.01_EDG=-	2
	1PLUS_CRM_TOP_103R-01B	DOUBLE FRONT BACK	PB-ST	18x50x1192	18X50X1192;NO EDGE	182004_STR=30.01_EDG=-	2
	1PLUS_CRM_TOP_103R-01C	DOUBLE LIFE RIGHT	PB-ST	18x110x550	18X110X550;NO EDGE	185000_STR=30.01_EDG=-	2
	1PLUS_CRM_TOP_103R-01C	DOUBLE LIFE RIGHT	PB-ST	18x110x550	18X110X550;NO EDGE	185001_STR=30.01_EDG=-	2

Model	1PLUS_CRM_DBH602		
Creator	CHALEAMPHON	.BCP Name	INDEX_C3D_KITCHEN2
Reviewer		Order	H000947
Approves		Date	04/05/2024

1PLUS_CRM_DBH602-600X570X760

Colour

05.01=ML WHITE VM1012 18/18
07.18=AQ2 GRAND OAK WOODRIFT

Edge

01.47=1 WHITE
01.103=1 GRAND OAK AQ2 _ A613TH00

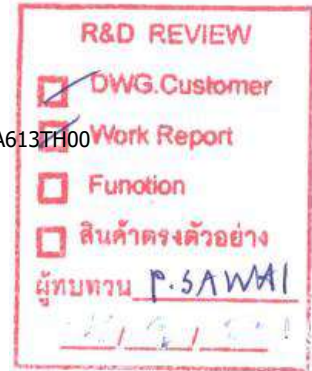

- K100R-160146703
- K101R-160149330
- K102R-160149340
- K103R-160149351
- K104R-160149361
- K105R-160149371

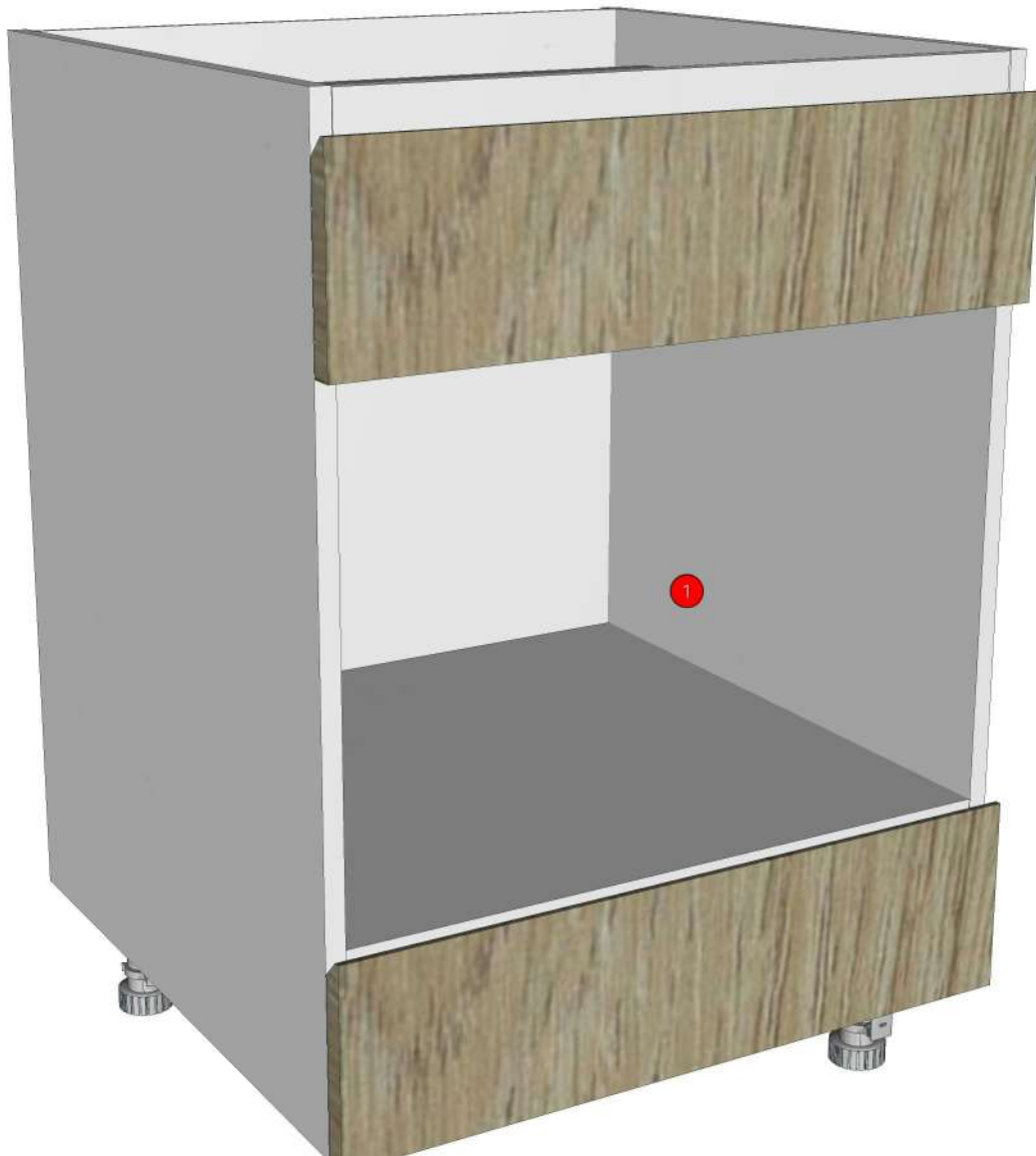

Model	-1PLUS_CRM		
Creator	CHALEAMPHON	.BCP Name	INDEX_C3D_KITCHEN2
Reviewer		Order	H000947
Approves		Date	04/05/2024

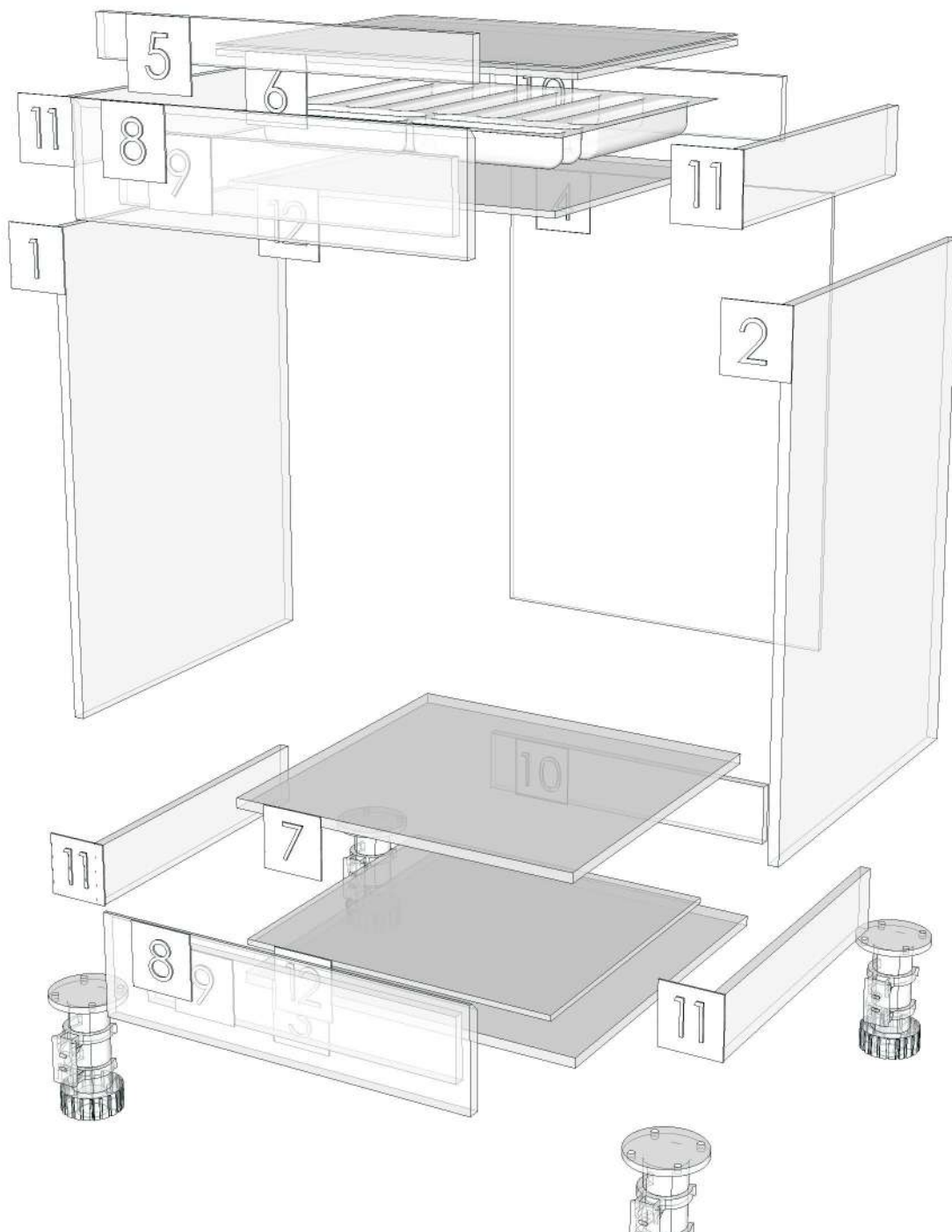

Model	1PLUS_CRM_DBS70		
Creator	CHALEAMPHON	.BCP Name	INDEX_C3D_KITCHEN2
Reviewer		Order	H001462
Approves		Date	17/01/2025

1PLUS_CRM_DBS70-700X570X760

Colour

20.07=ML.WHITE #VM1012 18/18(MATT)

07.18=AQ2 GRAND OAK WOODRIFT

Edge

01.47=1 WHITE

01.103=1 GRAND OAK AQ2 _ A613TH00



K103R-160149351

K104R-160149361



Model	-1PLUS_CRM		
Creator	CHALEAMPHON	.BCP Name	INDEX_C3D_KITCHEN2
Reviewer		Order	H001462
Approves		Date	17/01/2025

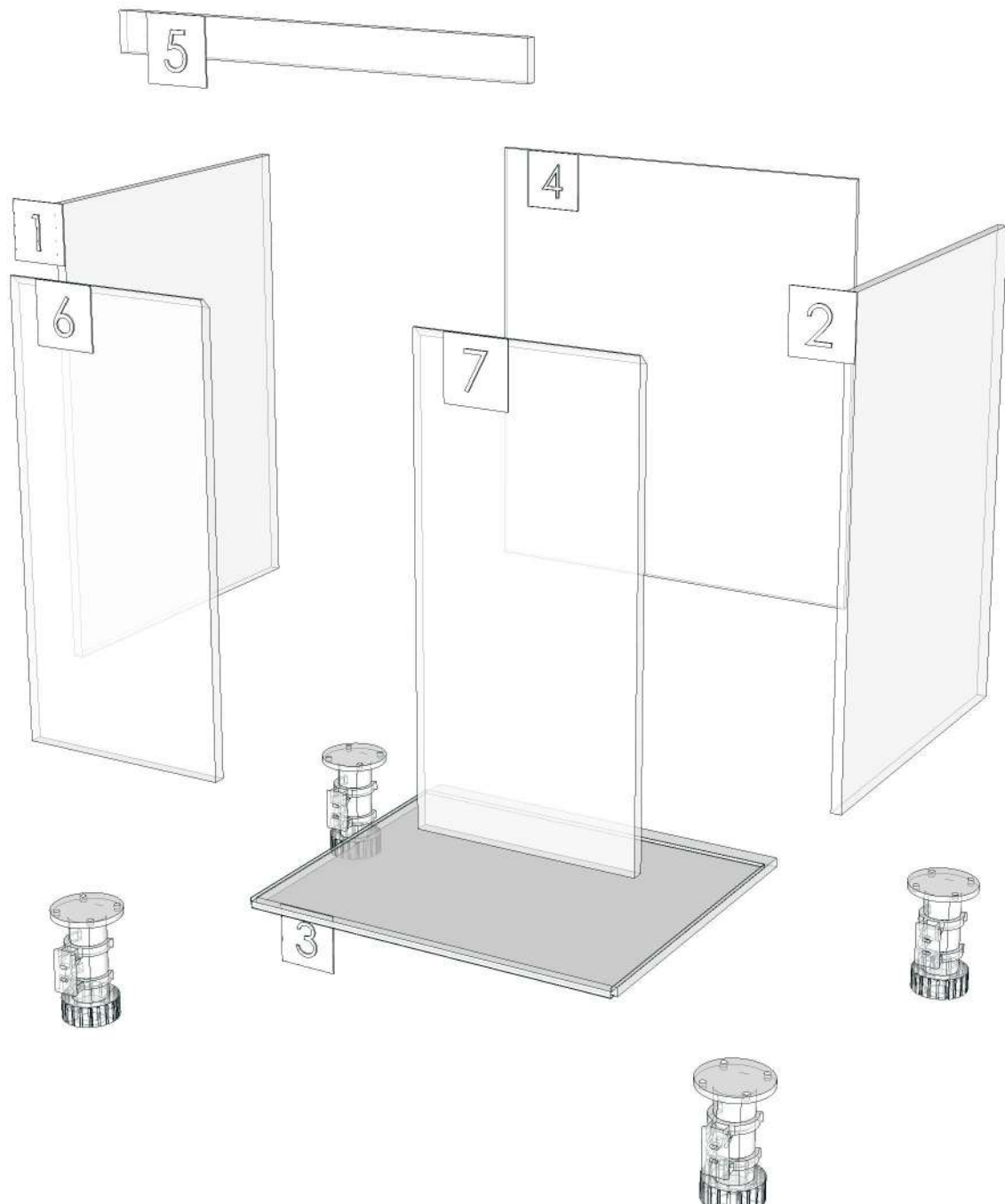

Model	1PLUS_CRM_DDM80		
Creator	CHALEAMPON	.BCP Name	INDEX_C3D_KITCHEN2
Reviewer		Order	H001465
Approves		Date	17/01/2025

1PLUS_CRM_DDM80-800X16X200

Colour

20.07=ML.WHITE #VM1012 18/18(MATT)

Edge

01.47=1 WHITE



K103R-160149351

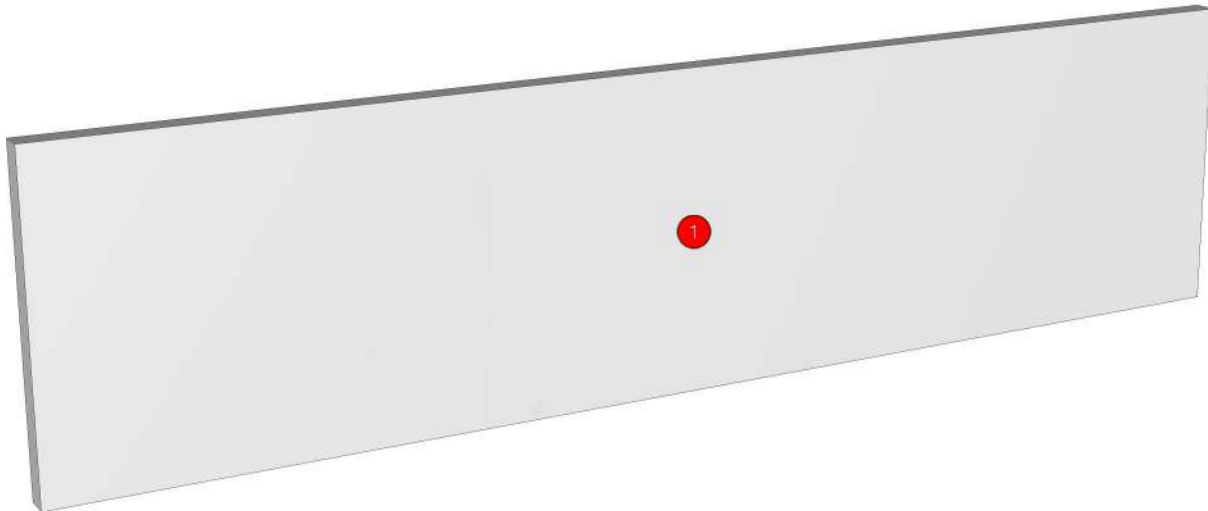

Model	1PLUS_CRM_DDM80		
Creator	CHALEAMPHON	.BCP Name	INDEX_C3D_KITCHEN2
Reviewer		Order	H001465
Approves		Date	17/01/2025

No.	Article No.	Description	Mat	Dimension	Cutting Size	Typepology	Skin
0	1PLUS_CRM_DDM80			800x200x16			
	1PLUS_CRM_DDM80-01	WALL MOUNT	PB-SP	16x200x800	16X198X799;L2:W1	183000 _STR=20.07 _EDG=WHITE-1	2

Model	1PLUS_CRM_DFB		
Creator	CHALEAMPHON	.BCP Name	INDEX_C3D_KITCHEN2
Reviewer		Order	H001467
Approves		Date	17/01/2025

1PLUS_CRM_DFB-150X570X760

Colour

20.07=ML.WHITE #VM1012 18/18(MATT)

07.18=AQ2 GRAND OAK WOODRIFT

Edge

01.47=1 WHITE

01.103=1 GRAND OAK AQ2 _ A613TH00

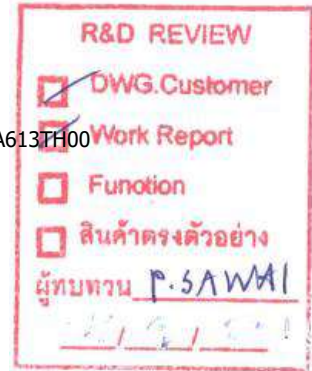

K102R-160149340

K103R-160149351

K104R-160149367

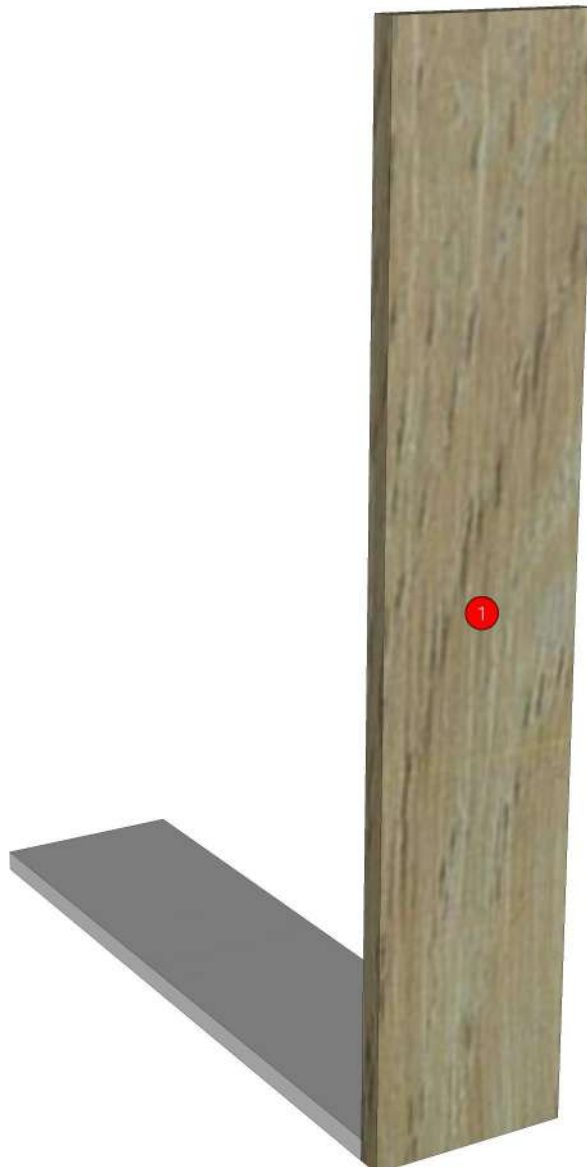

Model	-1PLUS_CRM		
Creator	CHALEAMPON	.BCP Name	INDEX_C3D_KITCHEN2
Reviewer		Order	H001467
Approves		Date	17/01/2025

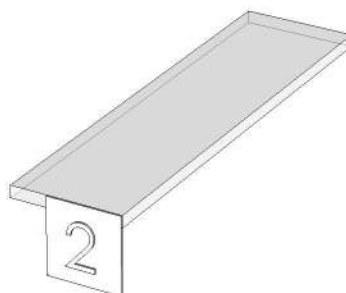
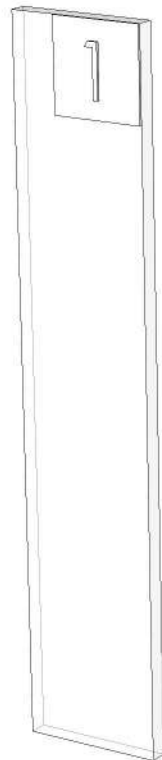

Model	1PLUS_CRM_DFW		
Creator	CHALEAMPHON	.BCP Name	INDEX_C3D_KITCHEN2
Reviewer		Order	H001469
Approves		Date	17/01/2025

1PLUS_CRM_DFW-150X300X400

Colour

20.07=ML.WHITE #VM1012 18/18(MATT)

07.18=AQ2 GRAND OAK WOODRIFT

Edge

01.47=1 WHITE

01.103=1 GRAND OAK AQ2 _ A613TH00



K103R-160149351

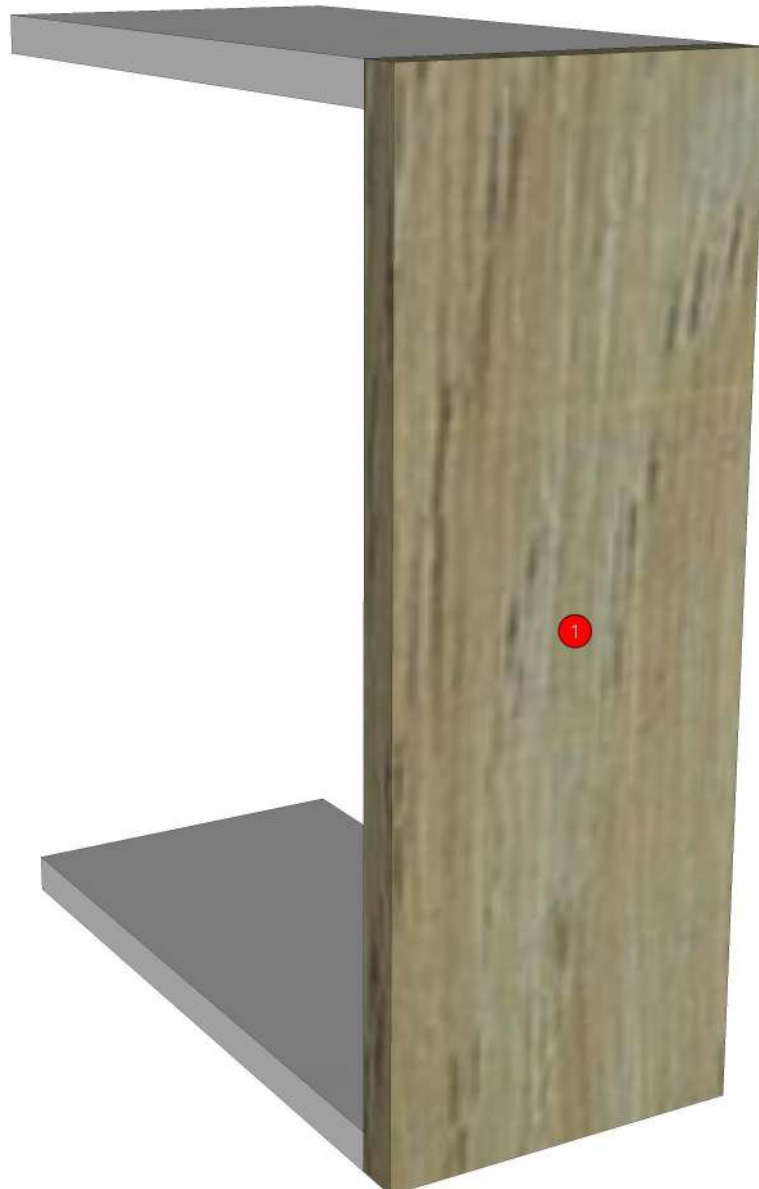

Model	-1PLUS_CRM		
Creator	CHALEAMPHON	.BCP Name	INDEX_C3D_KITCHEN2
Reviewer		Order	H001469
Approves		Date	17/01/2025

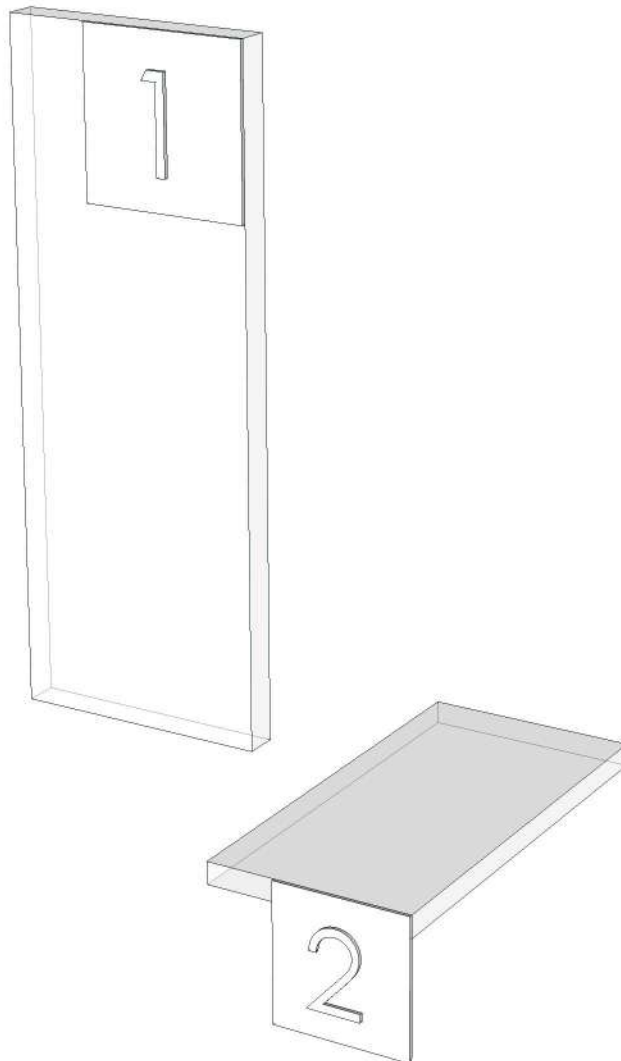
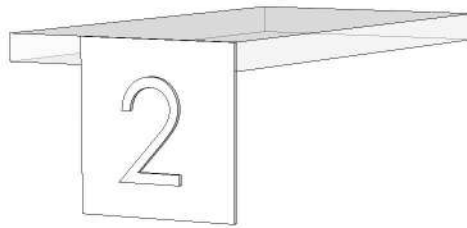

Model	1PLUS_CRM_DL60HL		
Creator	CHALEAMPHON	.BCP Name	INDEX_C3D_KITCHEN2
Reviewer		Order	H000950
Approves		Date	07/05/2024

1PLUS_CRM_DL60HL-600X300X555

Colour

05.01=ML WHITE VM1012 18/18
07.18=AQ2 GRAND OAK WOODRIFT

Edge

01.47=1 WHITE
01.103=1 GRAND OAK AQ2 _ A613TH00

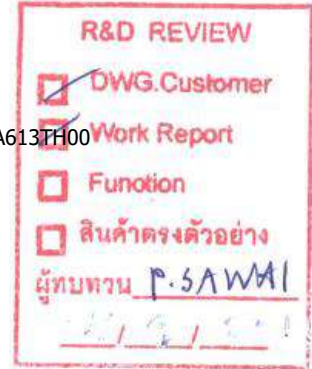

K100R-160146703
K101R-160149330
K102R-160149340
K103R-160149351
K104R-160149361
K105R-160149371

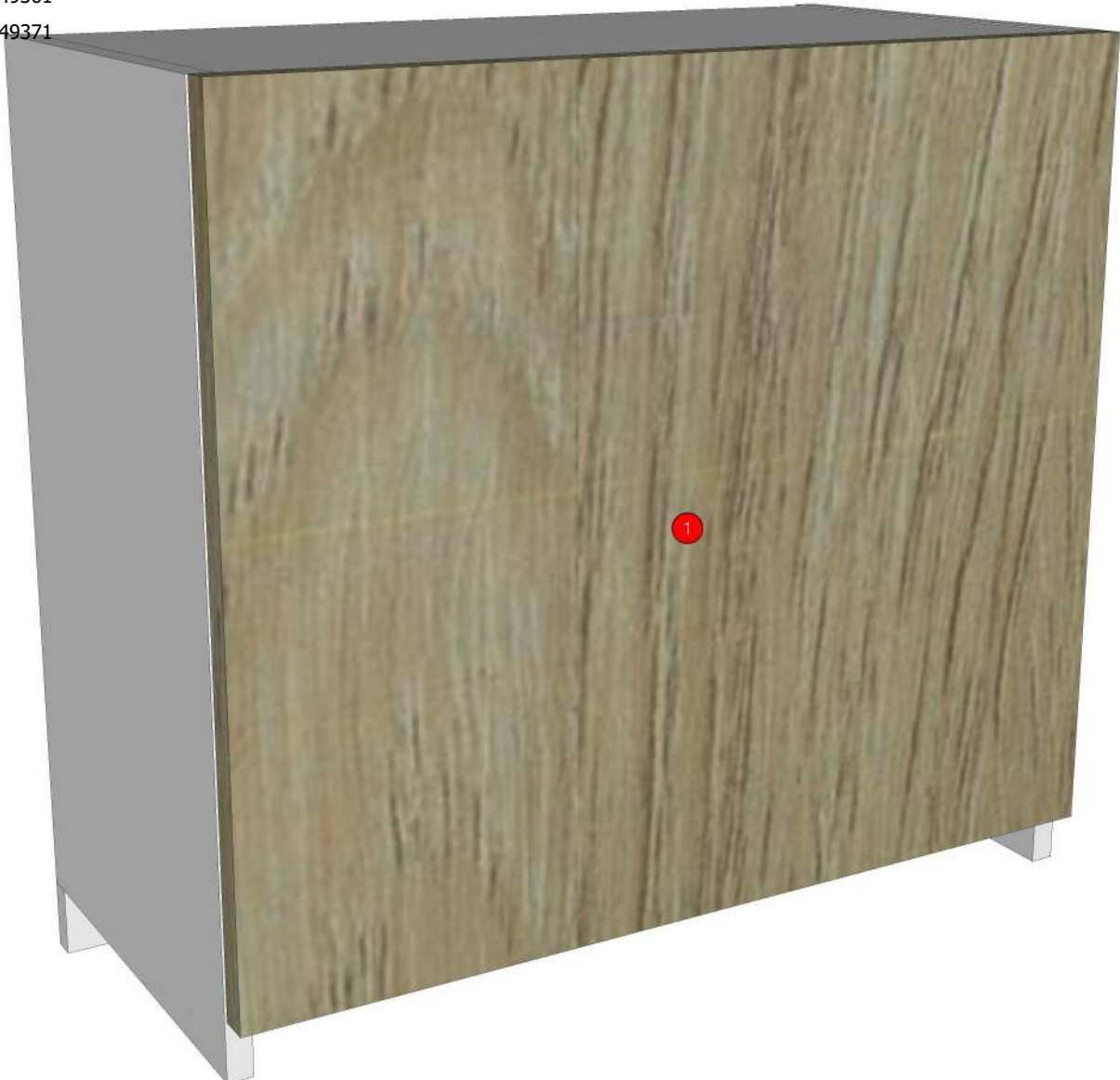

Model	-1PLUS_CRM		
Creator	CHALEAMPHON	.BCP Name	INDEX_C3D_KITCHEN2
Reviewer		Order	H000950
Approves		Date	07/05/2024

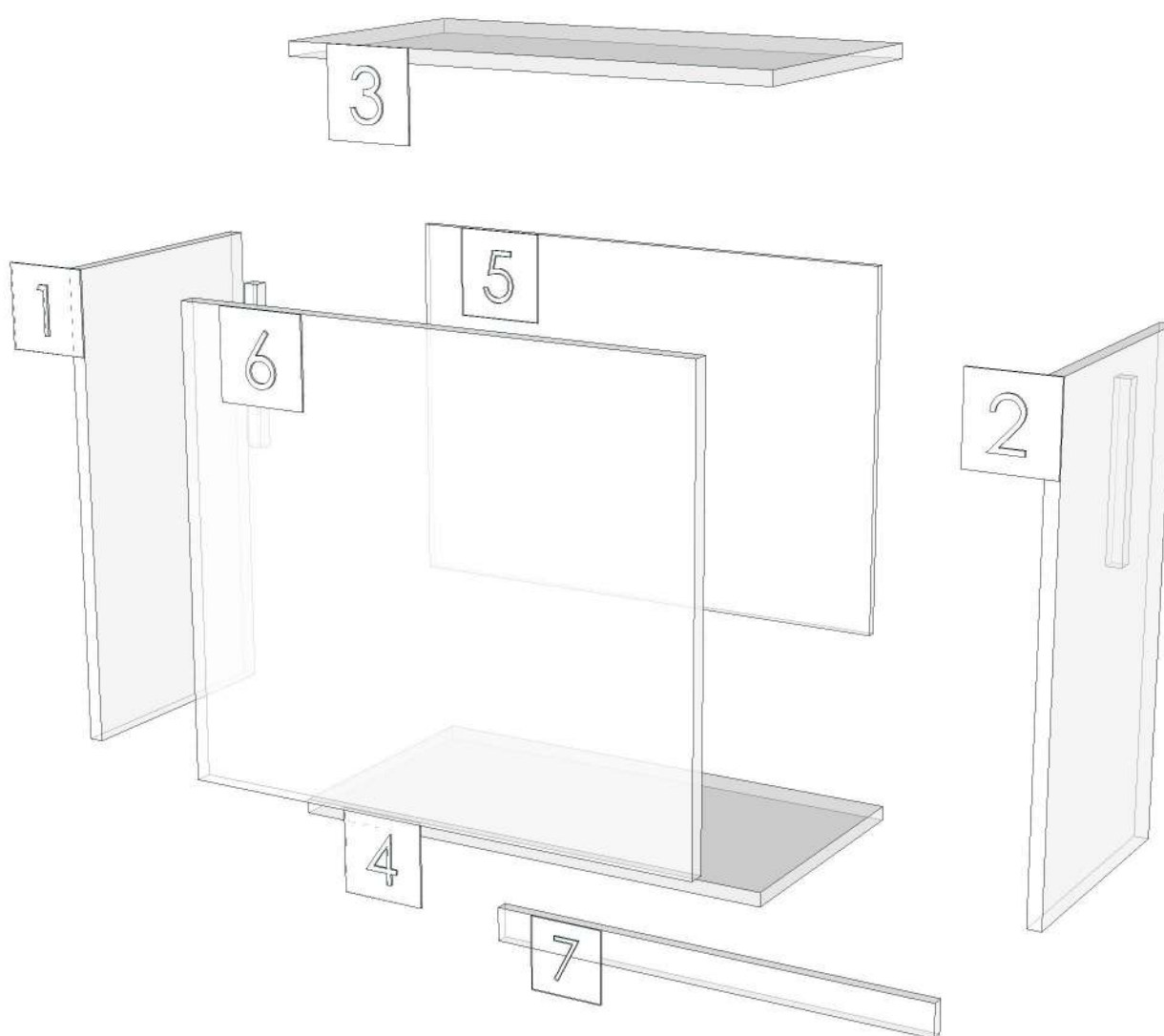

Model	1PLUS_CRM_DPLT_1400		
Creator	CHALEAMPON	.BCP Name	INDEX_C3D_KITCHEN2
Reviewer		Order	H001477
Approves		Date	17/01/2025

1PLUS_CRM_DPLT_1400-1400X12X100

Colour

Edge

-

-



K103R-160149351

K104R-160149361

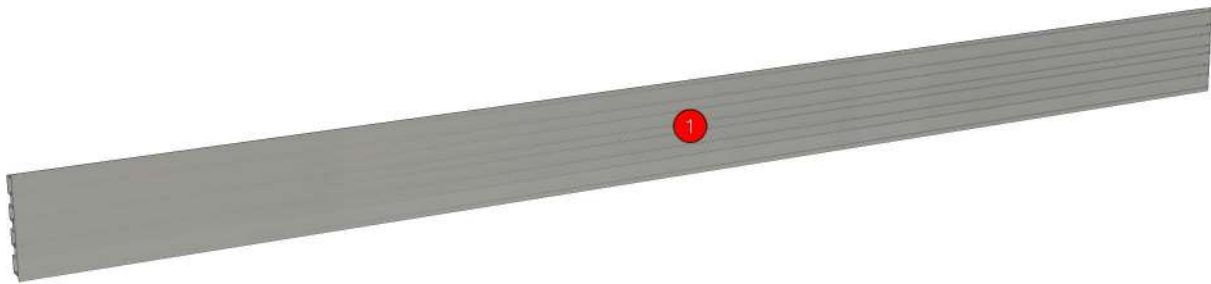

Model	1PLUS_CRM_DPLT_1400		
Creator	CHALEAMPHON	.BCP Name	INDEX_C3D_KITCHEN2
Reviewer		Order	H001477
Approves		Date	17/01/2025

No.	Article No.	Description	Mat	Dimension	Cutting Size	Typepology	Skin
0	1PLUS_CRM_DPLT_1400			1400x100x12			

Model	1PLUS_CRM_DPLT_600		
Creator	CHALEAMPON	.BCP Name	INDEX_C3D_KITCHEN2
Reviewer		Order	H000955
Approves		Date	08/05/2024

1PLUS_CRM_DPLT_600-600X12X100

Colour

Edge

-

-



- K100R-160146703
- K101R-160149330
- K102R-160149340
- K103R-160149351
- K104R-160149361
- K105R-160149371

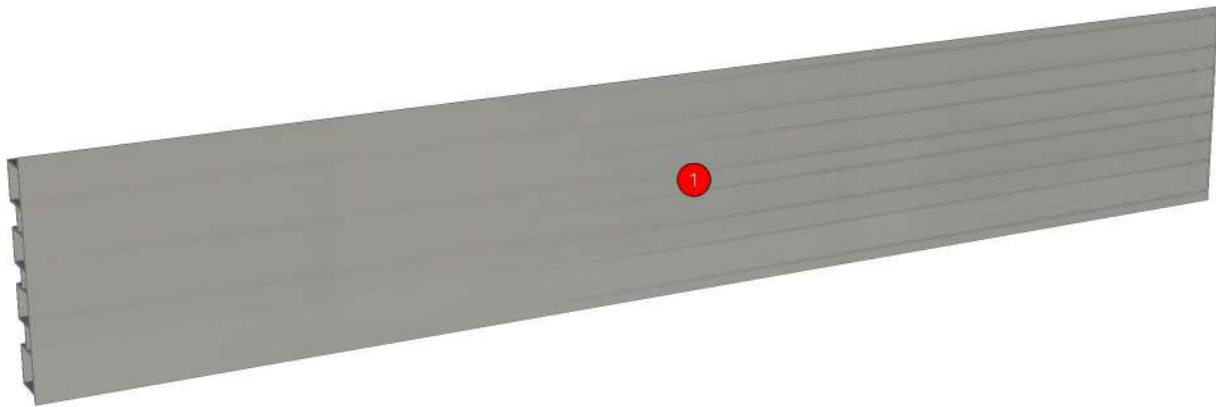

Model	1PLUS_CRM_DPLT_600		
Creator	CHALEAMPHON	.BCP Name	INDEX_C3D_KITCHEN2
Reviewer		Order	H000955
Approves		Date	08/05/2024

No.	Article No.	Description	Mat	Dimension	Cutting Size	Typepology	Skin
0	1PLUS_CRM_DPLT_600			600x100x12			

Model	1PLUS_CRM_DSH80		
Creator	CHALEAMPON	.BCP Name	INDEX_C3D_KITCHEN2
Reviewer		Order	H001472
Approves		Date	17/01/2025

1PLUS_CRM_DSH80-800X284X19

Colour

07.18=AQ2 GRAND OAK WOODRIFT

Edge

01.103=1 GRAND OAK AQ2 _ A613TH00

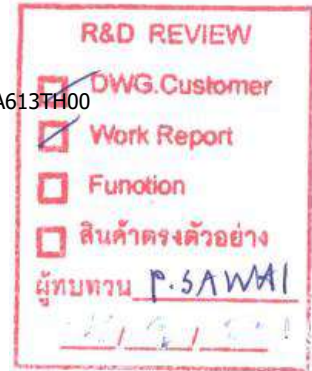

K103R-160149351



Model	1PLUS_CRM_DSH80		
Creator	CHALEAMPHON	.BCP Name	INDEX_C3D_KITCHEN2
Reviewer		Order	H001472
Approves		Date	17/01/2025

No.	Article No.	Description	Mat	Dimension	Cutting Size	Typepology	Skin
0	1PLUS_CRM_DSH80 1PLUS_CRM_DSH80-01	SHELF	PB-ST	800x19x284 19x284x800	19X283X799;L1:W1	182000_STR=07.18_EDG=GRANDOAK-1	2

Model	1PLUS_CRM_DW70S		
Creator	CHALEAMPHON	.BCP Name	INDEX_C3D_KITCHEN2
Reviewer		Order	H001475
Approves		Date	17/01/2025

1PLUS_CRM_DW70S-700X300X400

Colour

20.07=ML.WHITE #VM1012 18/18(MATT)

07.18=AQ2 GRAND OAK WOODRIFT

Edge

01.47=1 WHITE

01.103=1 GRAND OAK AQ2 _ A613TH00

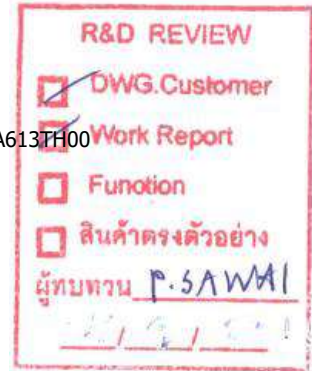

K103R-160149351

K104R-160149361

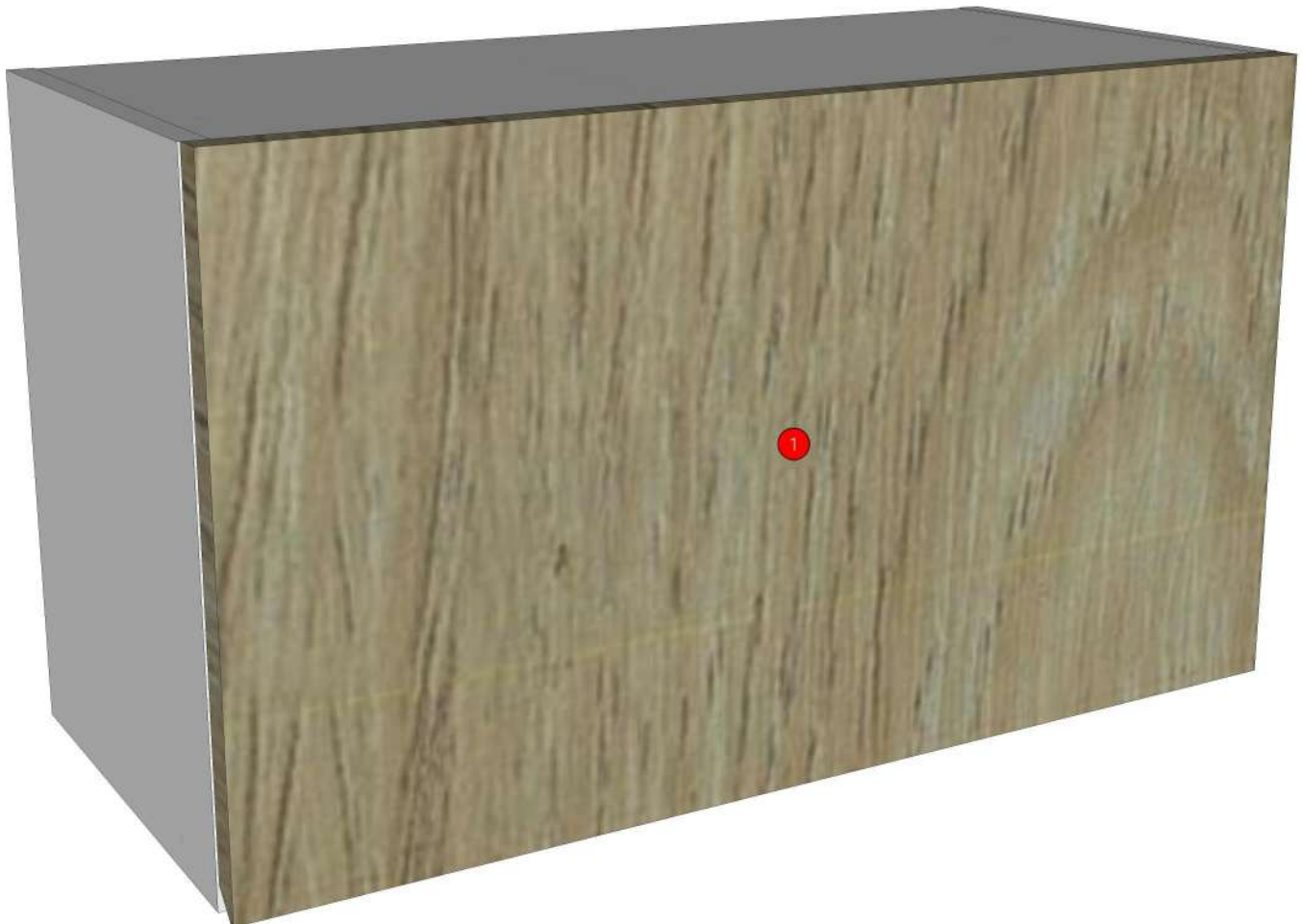

Model	-1PLUS_CRM		
Creator	CHALEAMPHON	.BCP Name	INDEX_C3D_KITCHEN2
Reviewer		Order	H001475
Approves		Date	17/01/2025

