

<b>Model</b>	1PLUS_CRM_DB30R		
<b>Creator</b>	CHALEAMPHON	<b>.BCP Name</b>	INDEX_C3D_KITCHEN2
<b>Reviewer</b>		<b>Order</b>	H000949
<b>Approves</b>		<b>Date</b>	07/05/2024

## **1PLUS\_CRM\_DB30R-300X570X760**

**Colour**

05.01=ML WHITE VM1012 18/18  
07.18=AQ2 GRAND OAK WOODRIFT

**Edge**

01.47=1 WHITE  
01.103=1 GRAND OAK AQ2 \_ A613TH00

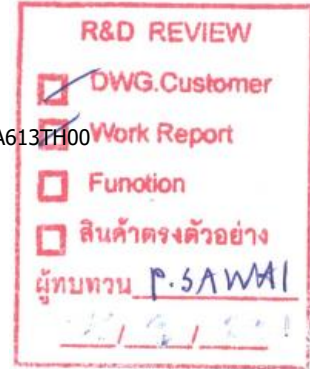

K100R-160146703

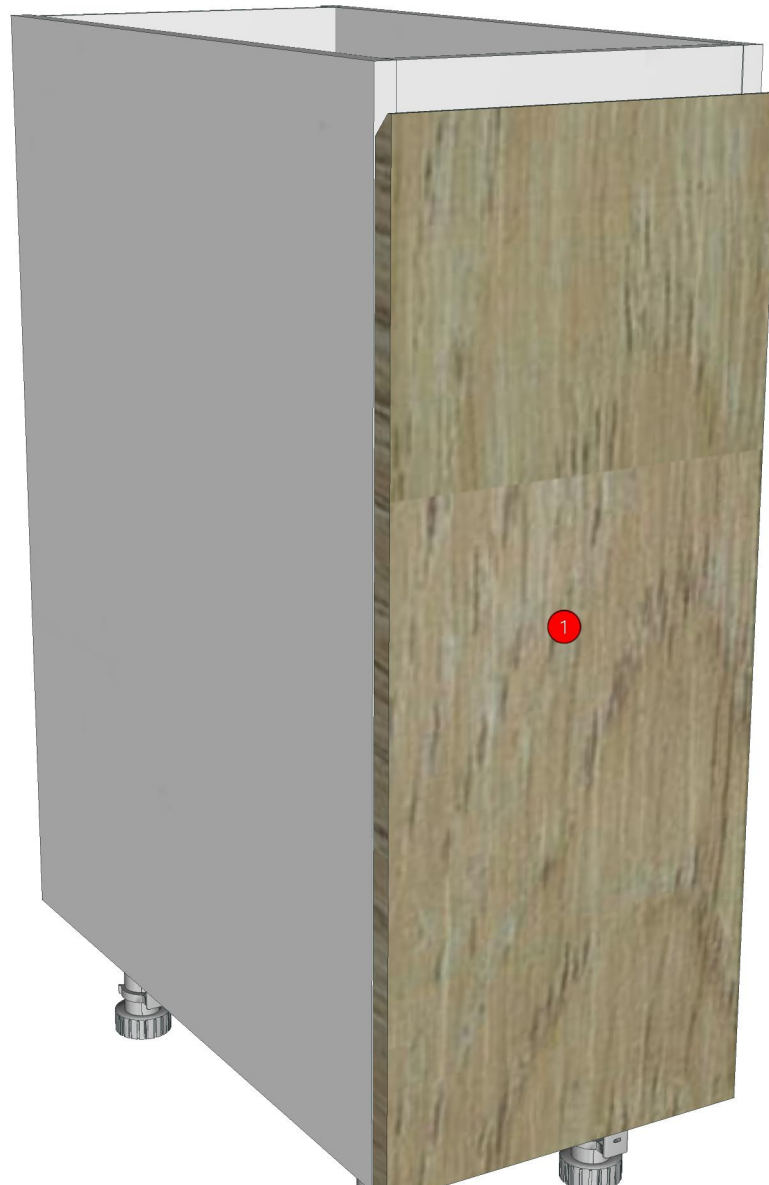

<b>Model</b>	-1PLUS_CRM		
<b>Creator</b>	CHALEAMPHON	<b>.BCP Name</b>	INDEX_C3D_KITCHEN2
<b>Reviewer</b>		<b>Order</b>	H000949
<b>Approves</b>		<b>Date</b>	07/05/2024

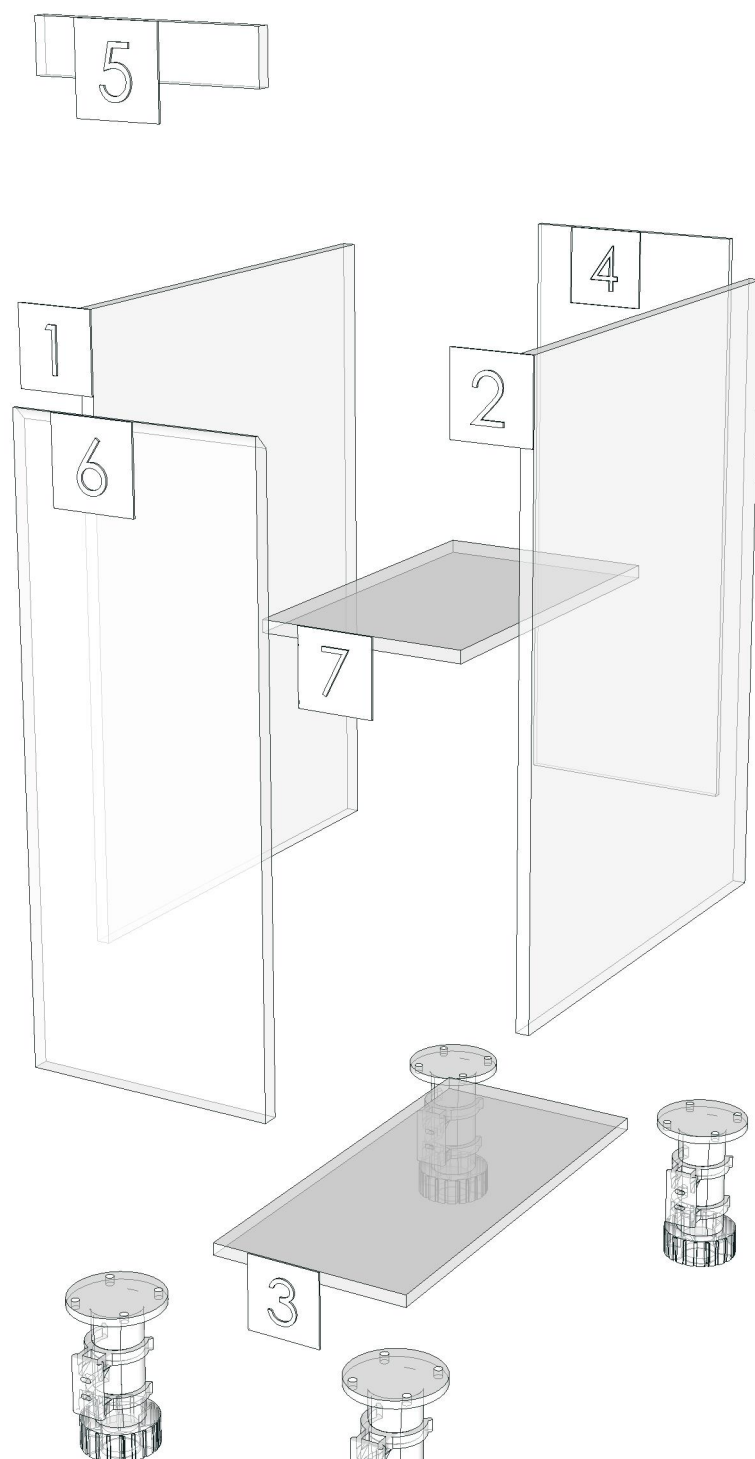

<b>Model</b>	1PLUS_CRM_DBH602		
<b>Creator</b>	CHALEAMPHON	<b>.BCP Name</b>	INDEX_C3D_KITCHEN2
<b>Reviewer</b>		<b>Order</b>	H000947
<b>Approves</b>		<b>Date</b>	04/05/2024

## 1PLUS\_CRM\_DBH602-600X570X760

**Colour**

05.01=ML WHITE VM1012 18/18  
07.18=AQ2 GRAND OAK WOODRIFT

**Edge**

01.47=1 WHITE  
01.103=1 GRAND OAK AQ2 \_ A613TH00

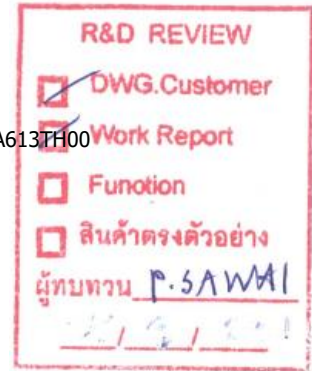

- K100R-160146703
- K101R-160149330
- K102R-160149340
- K103R-160149351
- K104R-160149361
- K105R-160149371

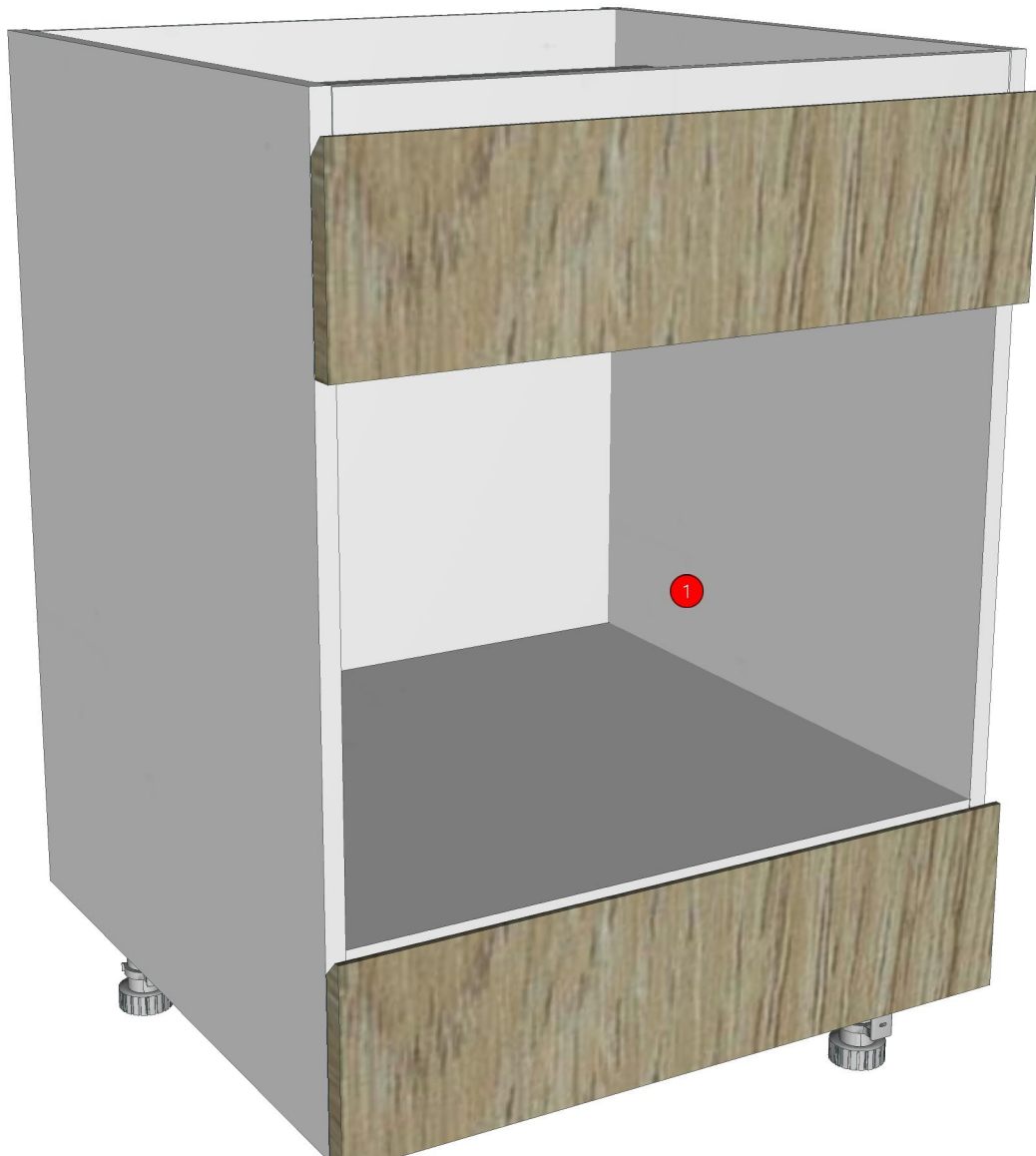

<b>Model</b>	-1PLUS_CRM		
<b>Creator</b>	CHALEAMPHON	<b>.BCP Name</b>	INDEX_C3D_KITCHEN2
<b>Reviewer</b>		<b>Order</b>	H000947
<b>Approves</b>		<b>Date</b>	04/05/2024

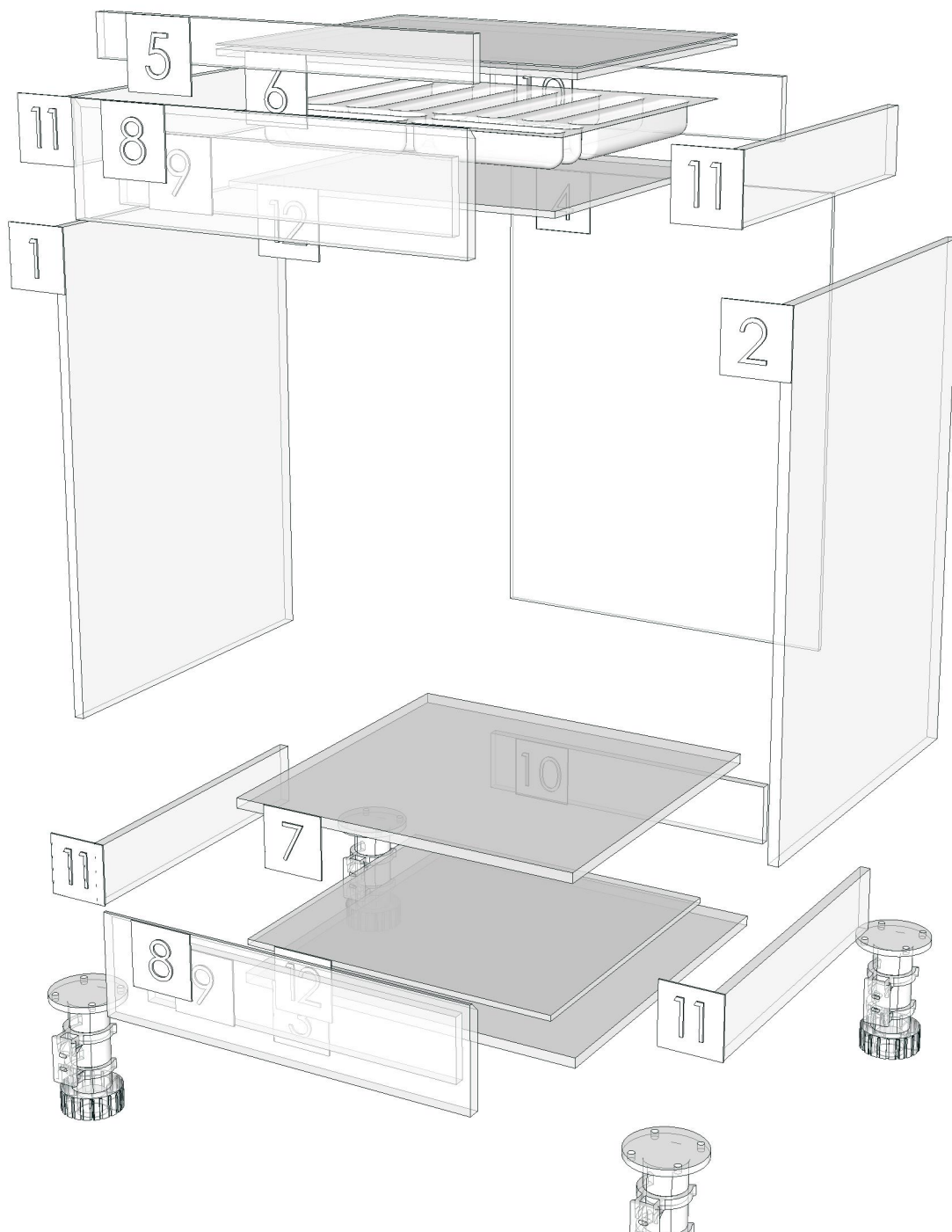

<b>Model</b>	1PLUS_CRM_DBS60L		
<b>Creator</b>	CHALEAMPHON	<b>.BCP Name</b>	INDEX_C3D_KITCHEN2
<b>Reviewer</b>		<b>Order</b>	H000948
<b>Approves</b>		<b>Date</b>	07/05/2024

## **1PLUS\_CRM\_DBS60L-600X570X760**

### **Colour**

05.01=ML WHITE VM1012 18/18  
07.18=AQ2 GRAND OAK WOODRIFT

### **Edge**

01.47=1 WHITE  
01.103=1 GRAND OAK AQ2 \_ A613TH00

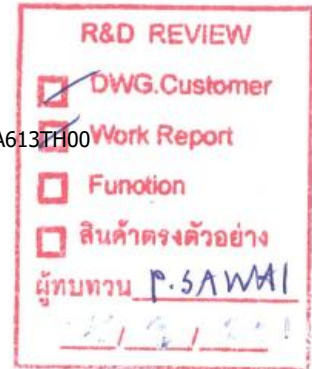

K100R-160146703  
K101R-160149330  
K102R-160149340  
K105R-160149371



<b>Model</b>	-1PLUS_CRM		
<b>Creator</b>	CHALEAMPHON	<b>.BCP Name</b>	INDEX_C3D_KITCHEN2
<b>Reviewer</b>		<b>Order</b>	H000948
<b>Approves</b>		<b>Date</b>	07/05/2024

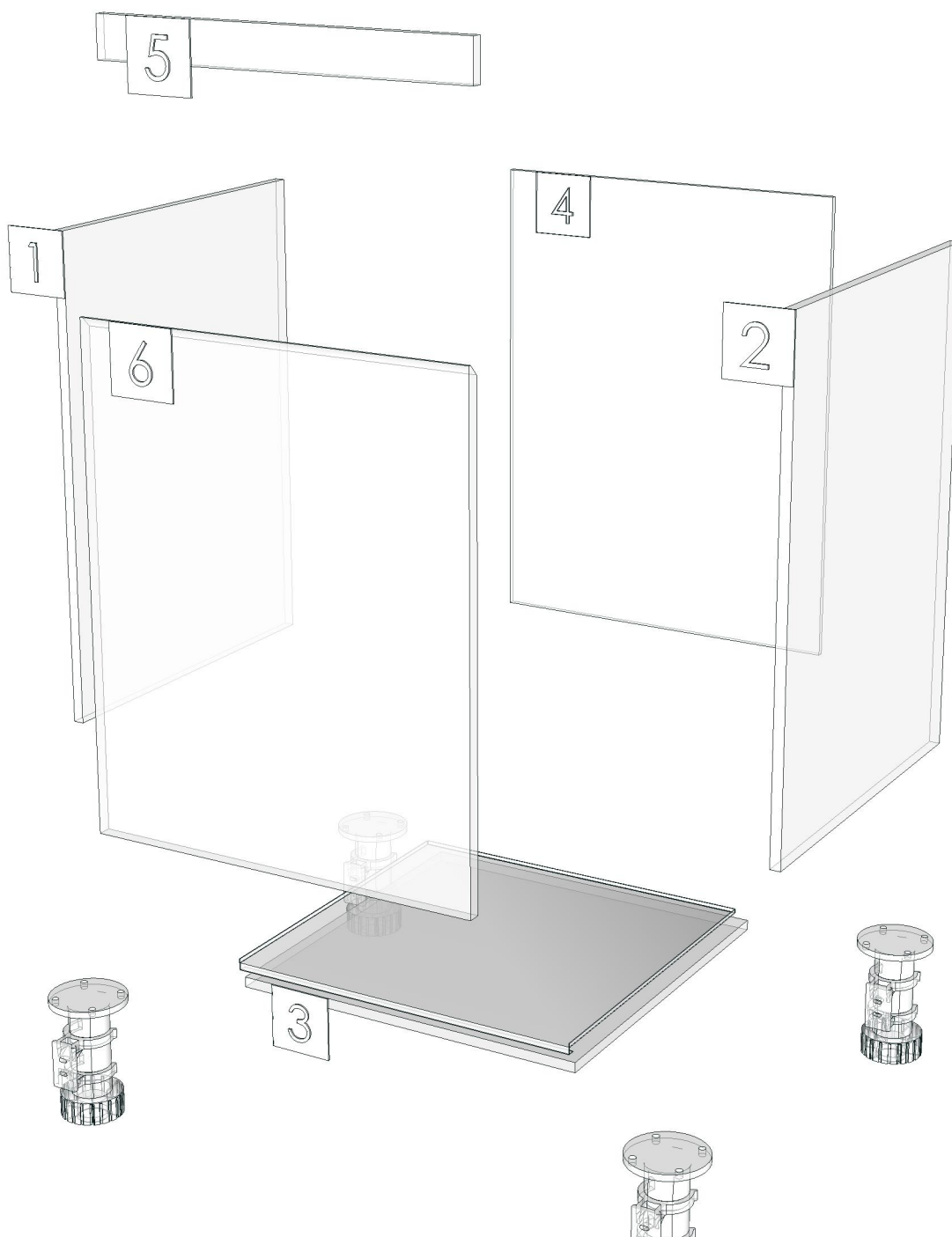

<b>Model</b>	1PLUS_CRM_DDM90		
<b>Creator</b>	CHALEAMPON	<b>.BCP Name</b>	INDEX_C3D_KITCHEN2
<b>Reviewer</b>		<b>Order</b>	H000952
<b>Approves</b>		<b>Date</b>	08/05/2024

## **1PLUS\_CRM\_DDM90-900X16X200**

**Colour**

05.01=ML WHITE VM1012 18/18

**Edge**

01.47=1 WHITE



K100R-160146703

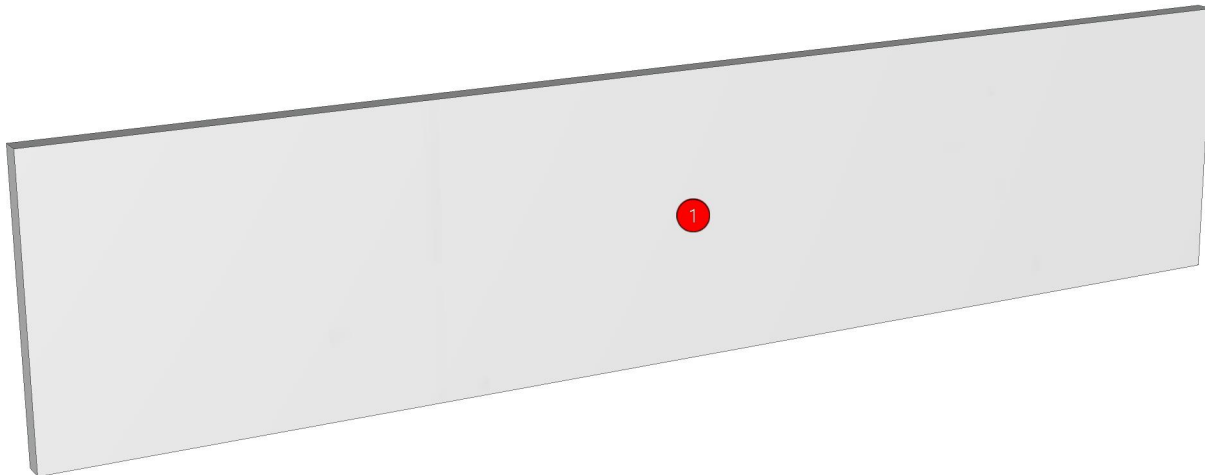

<b>Model</b>	1PLUS_CRM_DDM90		
<b>Creator</b>	CHALEAMPHON	<b>.BCP Name</b>	INDEX_C3D_KITCHEN2
<b>Reviewer</b>		<b>Order</b>	H000952
<b>Approves</b>		<b>Date</b>	08/05/2024

No.	Article No.	Description	Mat	Dimension	Cutting Size	Typepology	Skin
0	1PLUS_CRM_DDM90			900x200x16			
	1PLUS_CRM_DDM90-01	WALL MOUNT	PB-SP	16x200x900	16X198X898;L2:W2	183000 _STR=05.01 _EDG=WHITE-1	2

<b>Model</b>	1PLUS_CRM_DL60HL		
<b>Creator</b>	CHALEAMPHON	<b>.BCP Name</b>	INDEX_C3D_KITCHEN2
<b>Reviewer</b>		<b>Order</b>	H000950
<b>Approves</b>		<b>Date</b>	07/05/2024

## **1PLUS\_CRM\_DL60HL-600X300X555**

### **Colour**

05.01=ML WHITE VM1012 18/18  
07.18=AQ2 GRAND OAK WOODRIFT

### **Edge**

01.47=1 WHITE  
01.103=1 GRAND OAK AQ2 \_ A613TH00

<b>R&amp;D REVIEW</b>	
<input checked="" type="checkbox"/>	DWG.Customer
<input checked="" type="checkbox"/>	Work Report
<input type="checkbox"/>	Function
<input type="checkbox"/>	สินค้าตรงตัวอย่าง
ผู้ทบทวน <u>P.SAWAI</u>	
<u>22/5/24</u>	

K100R-160146703  
K101R-160149330  
K102R-160149340  
K103R-160149351  
K104R-160149361  
K105R-160149371

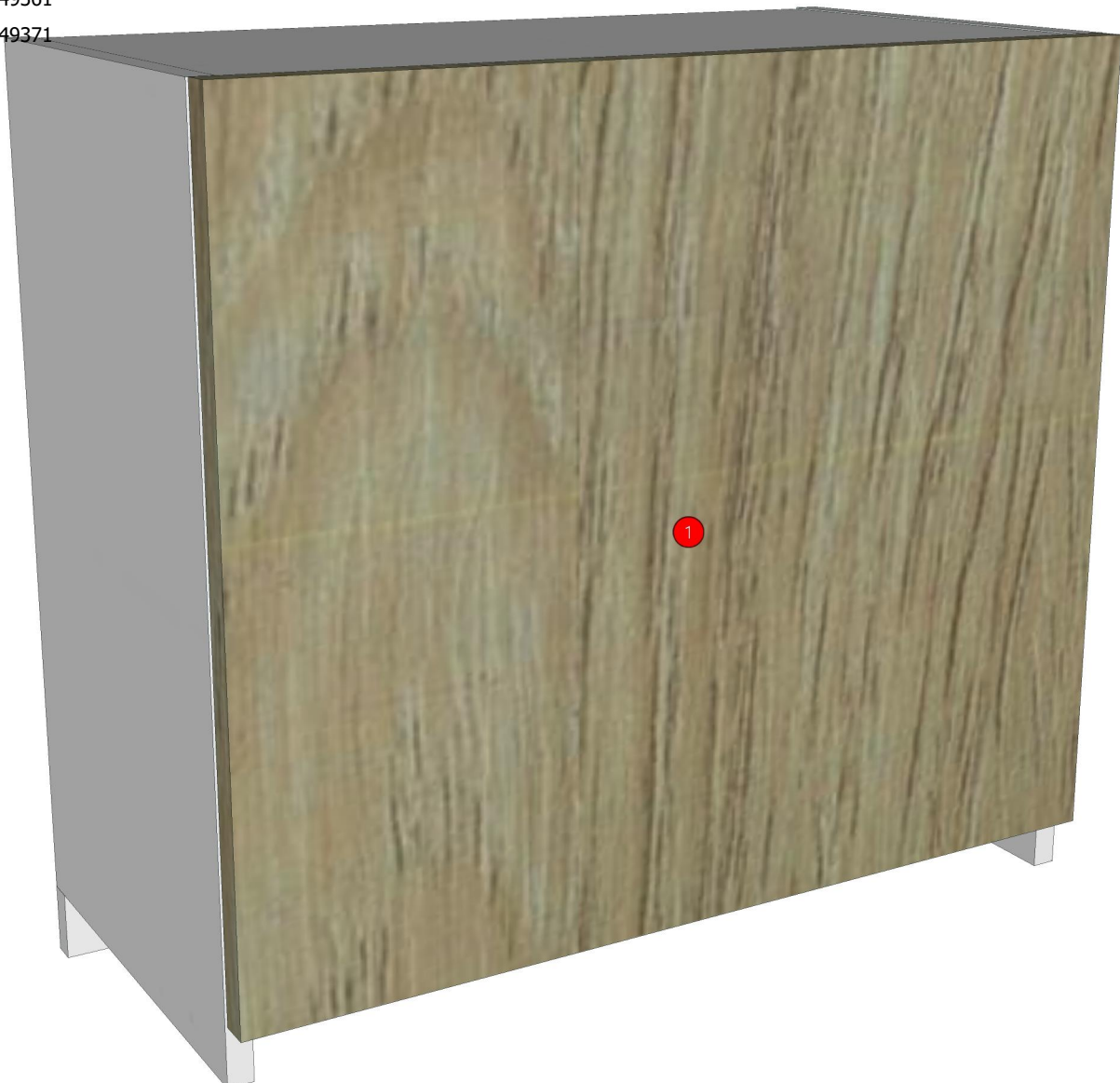

<b>Model</b>	-1PLUS_CRM		
<b>Creator</b>	CHALEAMPHON	<b>.BCP Name</b>	INDEX_C3D_KITCHEN2
<b>Reviewer</b>		<b>Order</b>	H000950
<b>Approves</b>		<b>Date</b>	07/05/2024

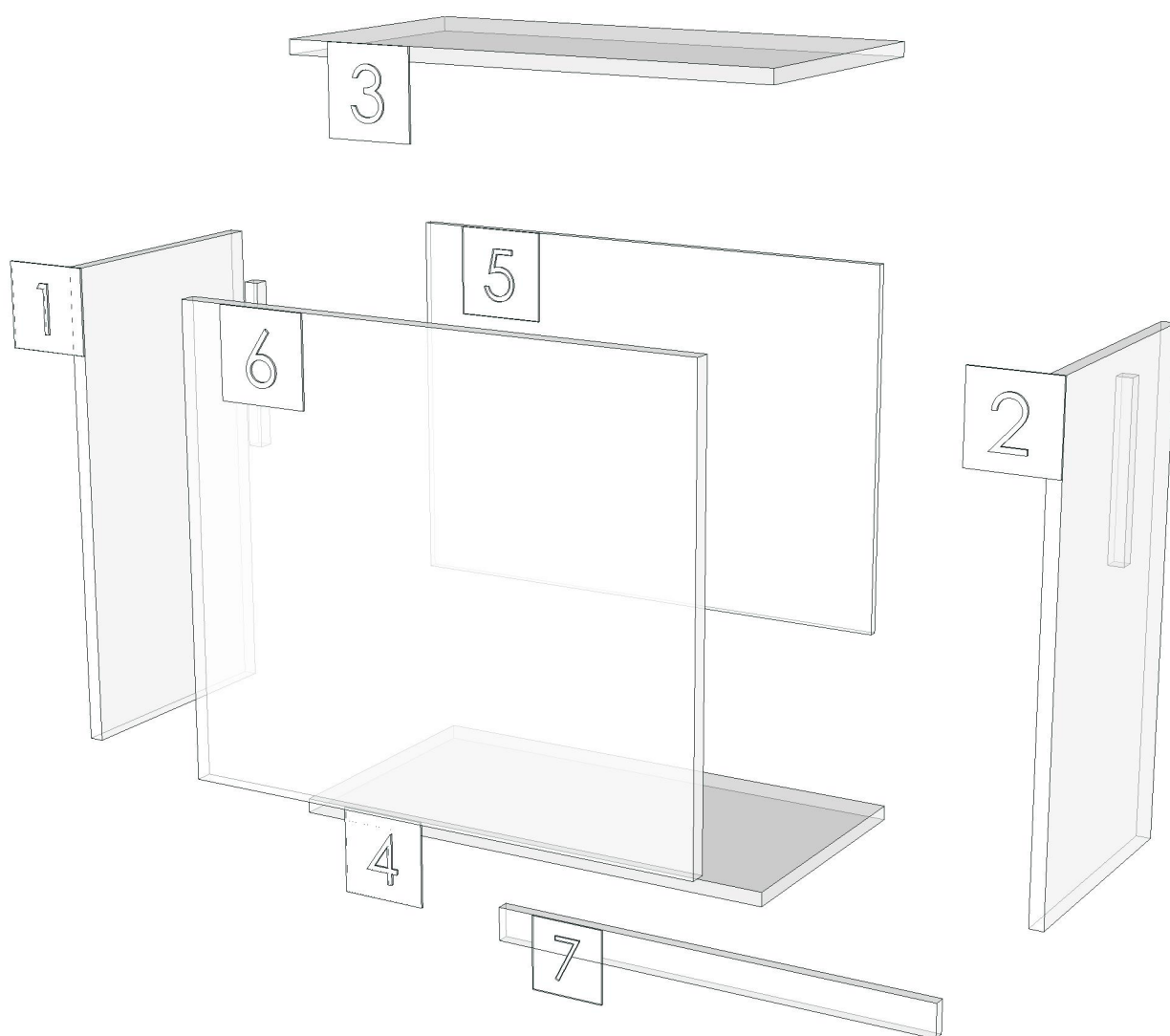

<b>Model</b>	1PLUS_CRM_DPLT_1500		
<b>Creator</b>	CHALEAMPON	<b>.BCP Name</b>	INDEX_C3D_KITCHEN2
<b>Reviewer</b>		<b>Order</b>	H000954
<b>Approves</b>		<b>Date</b>	08/05/2024

## **1PLUS\_CRM\_DPLT\_1500-1500X12X100**

Colour

Edge

-



K100R-160146703

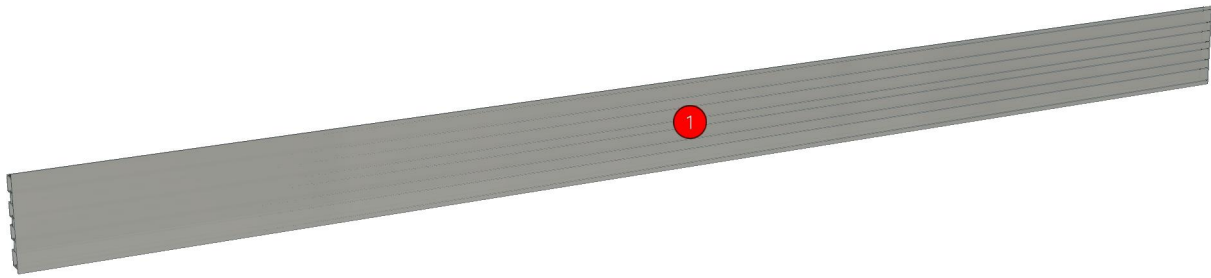

<b>Model</b>	1PLUS_CRM_DPLT_1500		
<b>Creator</b>	CHALEAMPON	<b>.BCP Name</b>	INDEX_C3D_KITCHEN2
<b>Reviewer</b>		<b>Order</b>	H000954
<b>Approves</b>		<b>Date</b>	08/05/2024

No.	Article No.	Description	Mat	Dimension	Cutting Size	Typepology	Skin
0	1PLUS_CRM_DPLT_1500			1500x100x12			

<b>Model</b>	1PLUS_CRM_DPLT_600		
<b>Creator</b>	CHALEAMPON	<b>.BCP Name</b>	INDEX_C3D_KITCHEN2
<b>Reviewer</b>		<b>Order</b>	H000955
<b>Approves</b>		<b>Date</b>	08/05/2024

## **1PLUS\_CRM\_DPLT\_600-600X12X100**

Colour

Edge

-

-



- K100R-160146703
- K101R-160149330
- K102R-160149340
- K103R-160149351
- K104R-160149361
- K105R-160149371

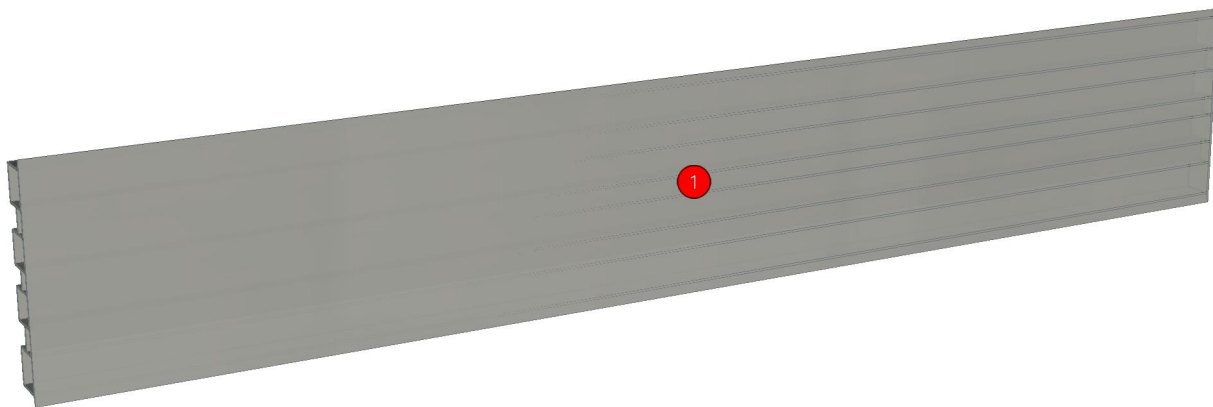

<b>Model</b>	1PLUS_CRM_DPLT_600		
<b>Creator</b>	CHALEAMPON	<b>.BCP Name</b>	INDEX_C3D_KITCHEN2
<b>Reviewer</b>		<b>Order</b>	H000955
<b>Approves</b>		<b>Date</b>	08/05/2024

No.	Article No.	Description	Mat	Dimension	Cutting Size	Typepology	Skin
0	1PLUS_CRM_DPLT_600			600x100x12			

<b>Model</b>	1PLUS_CRM_DSH90		
<b>Creator</b>	CHALEAMPON	<b>.BCP Name</b>	INDEX_C3D_KITCHEN2
<b>Reviewer</b>		<b>Order</b>	H000953
<b>Approves</b>		<b>Date</b>	08/05/2024

## **1PLUS\_CRM\_DSH90-900X284X19**

**Colour**

07.18=AQ2 GRAND OAK WOODRIFT

**Edge**

01.103=1 GRAND OAK AQ2 \_ A613TH00

<b>R&amp;D REVIEW</b>	
<input checked="" type="checkbox"/>	DWG.Customer
<input checked="" type="checkbox"/>	Work Report
<input type="checkbox"/>	Function
<input type="checkbox"/>	สินค้าตรงตัวอย่าง
ผู้ทบทวน <u>P.SAWAI</u>	
<u>22/8/24</u>	

K100R-160146703



<b>Model</b>	1PLUS_CRM_DSH90		
<b>Creator</b>	CHALEAMPHON	<b>.BCP Name</b>	INDEX_C3D_KITCHEN2
<b>Reviewer</b>		<b>Order</b>	H000953
<b>Approves</b>		<b>Date</b>	08/05/2024

No.	Article No.	Description	Mat	Dimension	Cutting Size	Typepology	Skin
0	1PLUS_CRM_DSH90			900x19x284			
	1PLUS_CRM_DSH90-01	SHELF	PB-ST	19x284x900	19X283X898;L1:W2	182000_STR=07.18_EDG=GRANDOAK-1	2

<b>Model</b>	1PLUS_CRM_DW90S		
<b>Creator</b>	CHALEAMPON	<b>.BCP Name</b>	INDEX_C3D_KITCHEN2
<b>Reviewer</b>		<b>Order</b>	H000951
<b>Approves</b>		<b>Date</b>	07/05/2024

## **1PLUS\_CRM\_DW90S-900X300X400**

**Colour**

05.01=ML WHITE VM1012 18/18  
07.18=AQ2 GRAND OAK WOODRIFT

**Edge**

01.47=1 WHITE  
01.103=1 GRAND OAK AQ2 \_ A613TH00

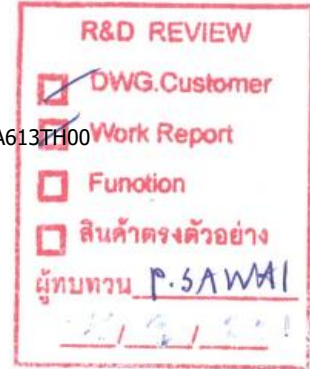

K100R-160146703

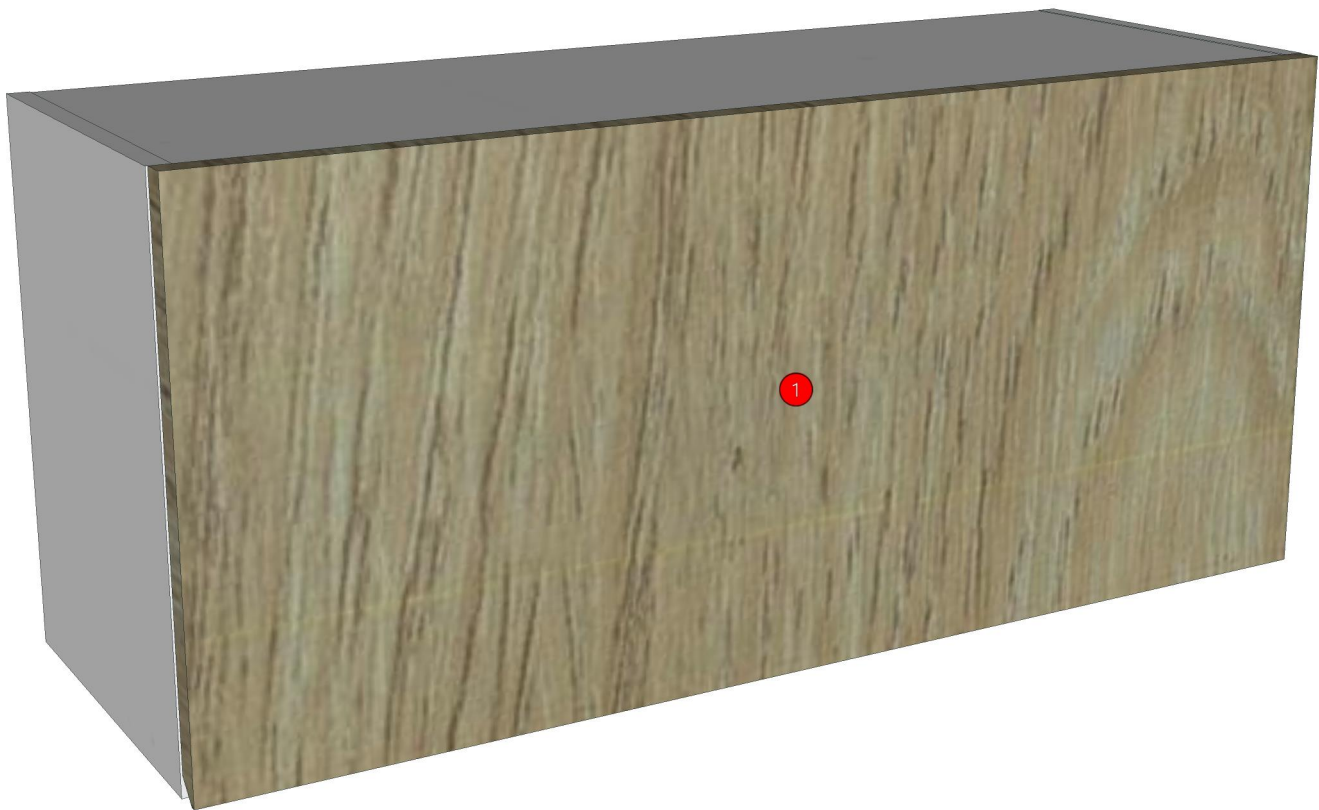

<b>Model</b>	-1PLUS_CRM		
<b>Creator</b>	CHALEAMPHON	<b>.BCP Name</b>	INDEX_C3D_KITCHEN2
<b>Reviewer</b>		<b>Order</b>	H000951
<b>Approves</b>		<b>Date</b>	07/05/2024

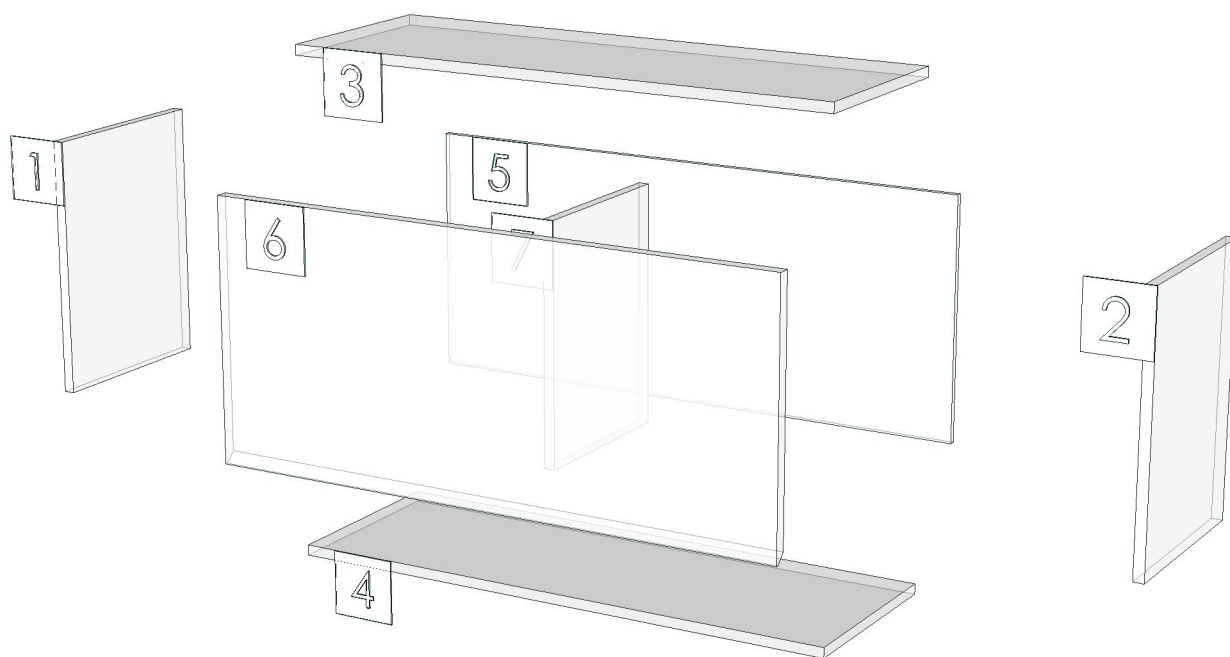

<b>Model</b>	1PLUS_CRM_TOP_100R		
<b>Creator</b>	CHALEAMPHON	<b>.BCP Name</b>	INDEX_C3D_KITCHEN2
<b>Reviewer</b>		<b>Order</b>	H000956
<b>Approves</b>		<b>Date</b>	08/05/2024

## **1PLUS\_CRM\_TOP\_100R-1504X600X38**

### **Colour**

04.26=LAMINATE HPL #8117-S

04.10=LAMINATE HPL # TD9201PL

20.07=ML.WHITE #VM1012 18/18(MATT)

30.02=NO SURFACE DAMP PROOF WOOD 18/18 (WET PROTECT)

### **Edge**

04.01=0.8 HPL



K100R-160146703

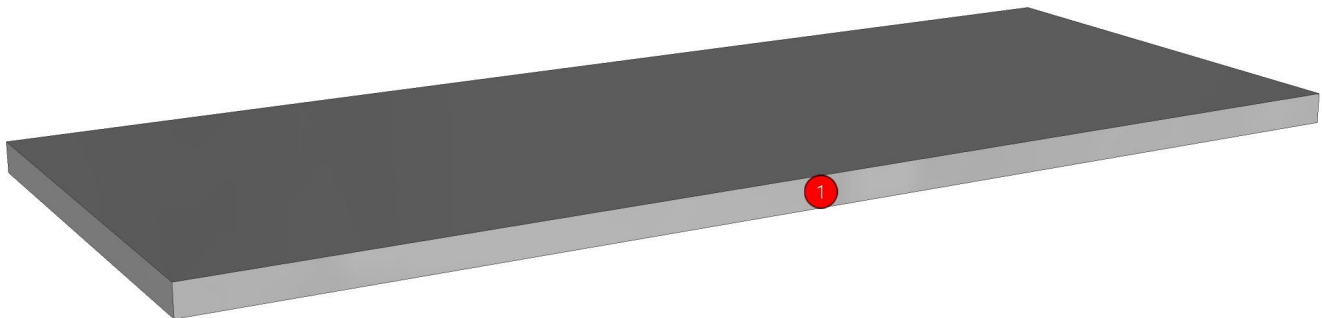

<b>Model</b>	1PLUS_CRM_TOP_100R		
<b>Creator</b>	CHALEAMPHON	<b>.BCP Name</b>	INDEX_C3D_KITCHEN2
<b>Reviewer</b>		<b>Order</b>	H000956
<b>Approves</b>		<b>Date</b>	08/05/2024

No.	Article No.	Description	Mat	Dimension	Cutting Size	Typepology	Skin
0	1PLUS_CRM_TOP_100R			1504x38x600			
	1PLUS_CRM_TOP_100R-01A	TOP ASSEMBLE COMPLETED	PB-ST	38x600x1504	38X600X1502.4;L0:W2	182000_STR=04.26_EDG=HPL-.8	2
	1PLUS_CRM_TOP_100R-01AA	TOP	PB-ST	18x600x1514	18X600X1514;NO EDGE	182001_STR=04.10_EDG=-	1
	1PLUS_CRM_TOP_100R-01AB	DOUBLE TOP	PB-ST	18x50x1514	18X50X1514;NO EDGE	182002_STR=30.02_EDG=-	
	1PLUS_CRM_TOP_100R-01B	DOUBLE FRONT BACK	PB-ST	18x50x1294	18X50X1294;NO EDGE	182004_STR=20.07_EDG=-	2
	1PLUS_CRM_TOP_100R-01B	DOUBLE FRONT BACK	PB-ST	18x50x1294	18X50X1294;NO EDGE	182003_STR=20.07_EDG=-	2
	1PLUS_CRM_TOP_100R-01C	DOUBLE LIFE RIGHT	PB-ST	18x110x550	18X110X550;NO EDGE	185000_STR=20.07_EDG=-	2
	1PLUS_CRM_TOP_100R-01C	DOUBLE LIFE RIGHT	PB-ST	18x110x550	18X110X550;NO EDGE	185001_STR=20.07_EDG=-	2