

<b>Model</b>	THE_NEXT_RC_DBH601		
<b>Creator</b>	CHALEAMPHON	<b>.BCP Name</b>	INDEX_C3D_KITCHEN2
<b>Reviewer</b>		<b>Order</b>	H000432
<b>Approves</b>		<b>Date</b>	21/12/2023

## **THE\_NEXT\_RC\_DBH601-600X570X788**

### **Colour**

20.46=ML.GREY MK3238 (PEARL)

20.56=ML.GREY MK3238 (MATT)

### **Edge**

01.227=1 LIGHT SAND GRAY-8E960M1

01.347=1 MK3238 HI-GROSS:102165 HG

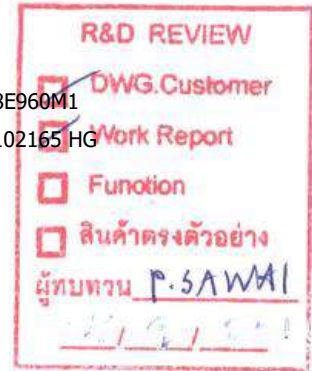

K100R-160121016

K101L-160134095



<b>Model</b>	-THE_NEXT_RC		
<b>Creator</b>	CHALEAMPHON	<b>.BCP Name</b>	INDEX_C3D_KITCHEN2
<b>Reviewer</b>		<b>Order</b>	H000432
<b>Approves</b>		<b>Date</b>	21/12/2023

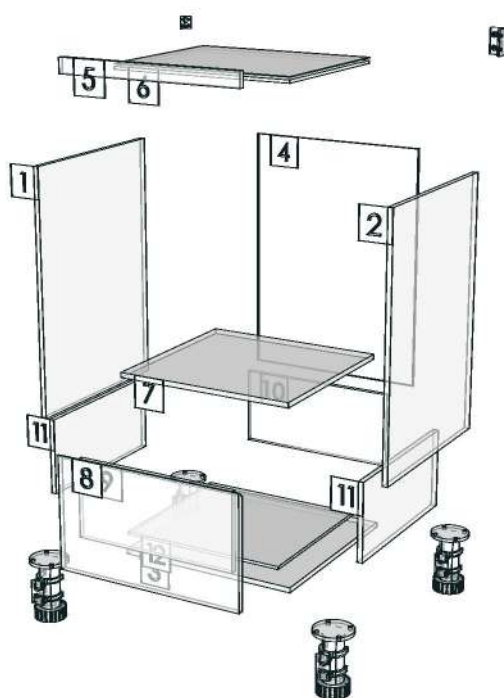

<b>Model</b>	NEXT_1_DBD202	<b>.BCP Name</b>	INDEX_C3D_KITCHEN2
<b>Creator</b>	CHALEAMPON	<b>Order</b>	H000763
<b>Reviewer</b>		<b>Date</b>	21/12/2023
<b>Approves</b>			

## NEXT\_1\_DBD202-200X570X788

### Colour

20.46=ML.GREY MK3238 (PEARL)

20.56=ML.GREY MK3238 (MATT)

### Edge

01.227=1 LIGHT SAND GRAY-8E960M1

01.347=1 MK3238 HI-GROSS:102165 HG

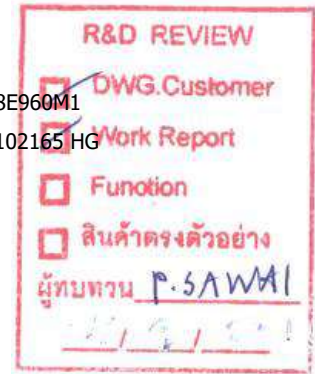

K100L-160134574

K100R-160121016

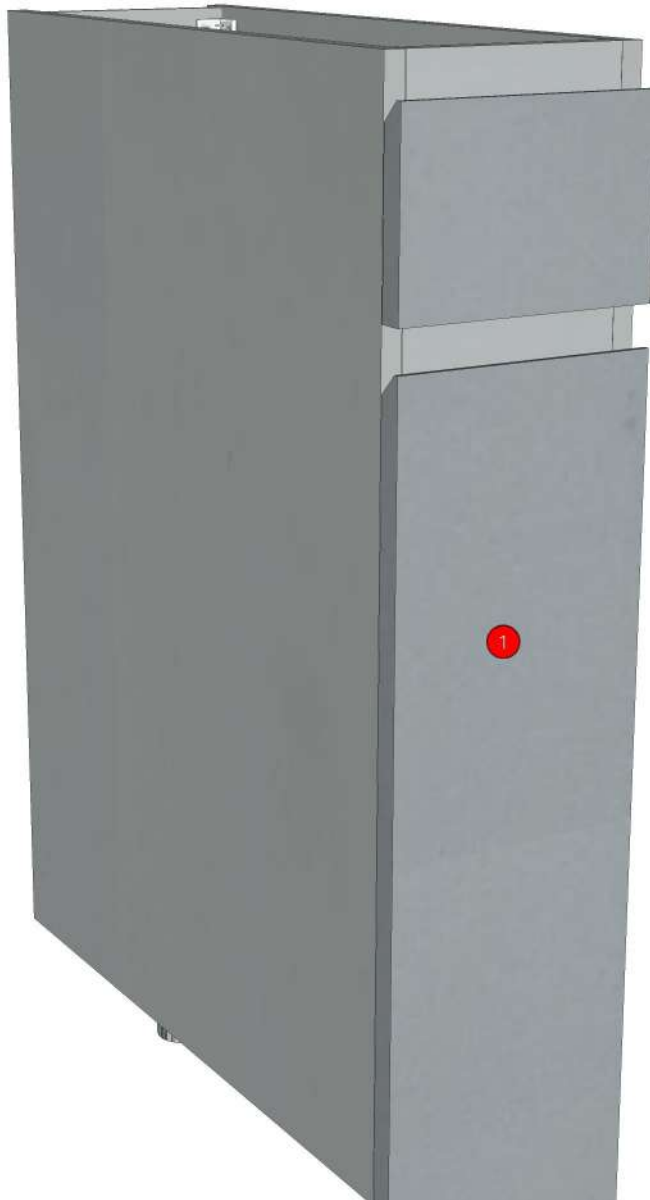

<b>Model</b>	-NEXT_1		
<b>Creator</b>	CHALEAMPON	<b>.BCP Name</b>	INDEX_C3D_KITCHEN2
<b>Reviewer</b>		<b>Order</b>	H000763
<b>Approves</b>		<b>Date</b>	21/12/2023

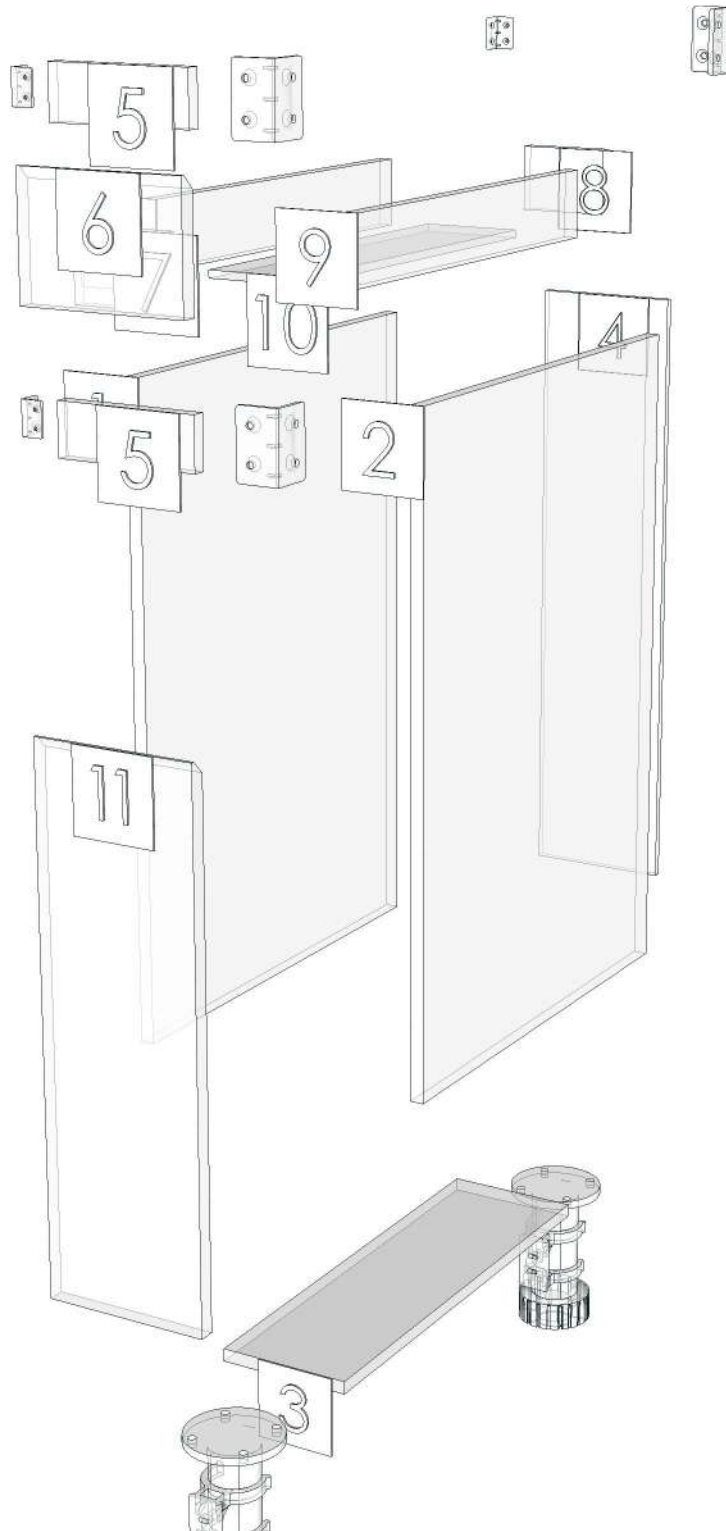

<b>Model</b>	NEXT_1_DBS55L		
<b>Creator</b>	CHALEAMPHON	<b>.BCP Name</b>	INDEX_C3D_KITCHEN2
<b>Reviewer</b>		<b>Order</b>	H000777
<b>Approves</b>		<b>Date</b>	23/01/2024

## **NEXT\_1\_DBS55L-550X570X788**

### **Colour**

20.46=ML.GREY MK3238 (PEARL)

20.56=ML.GREY MK3238 (MATT)

### **Edge**

01.227=1 LIGHT SAND GRAY-8E960M1

01.347=1 MK3238 HI-GROSS:102165 HG

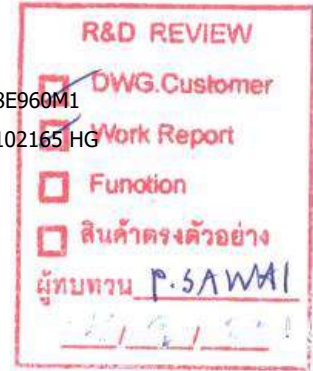

K100L-160134574



<b>Model</b>	-NEXT_1		
<b>Creator</b>	CHALEAMPHON	<b>.BCP Name</b>	INDEX_C3D_KITCHEN2
<b>Reviewer</b>		<b>Order</b>	H000777
<b>Approves</b>		<b>Date</b>	23/01/2024

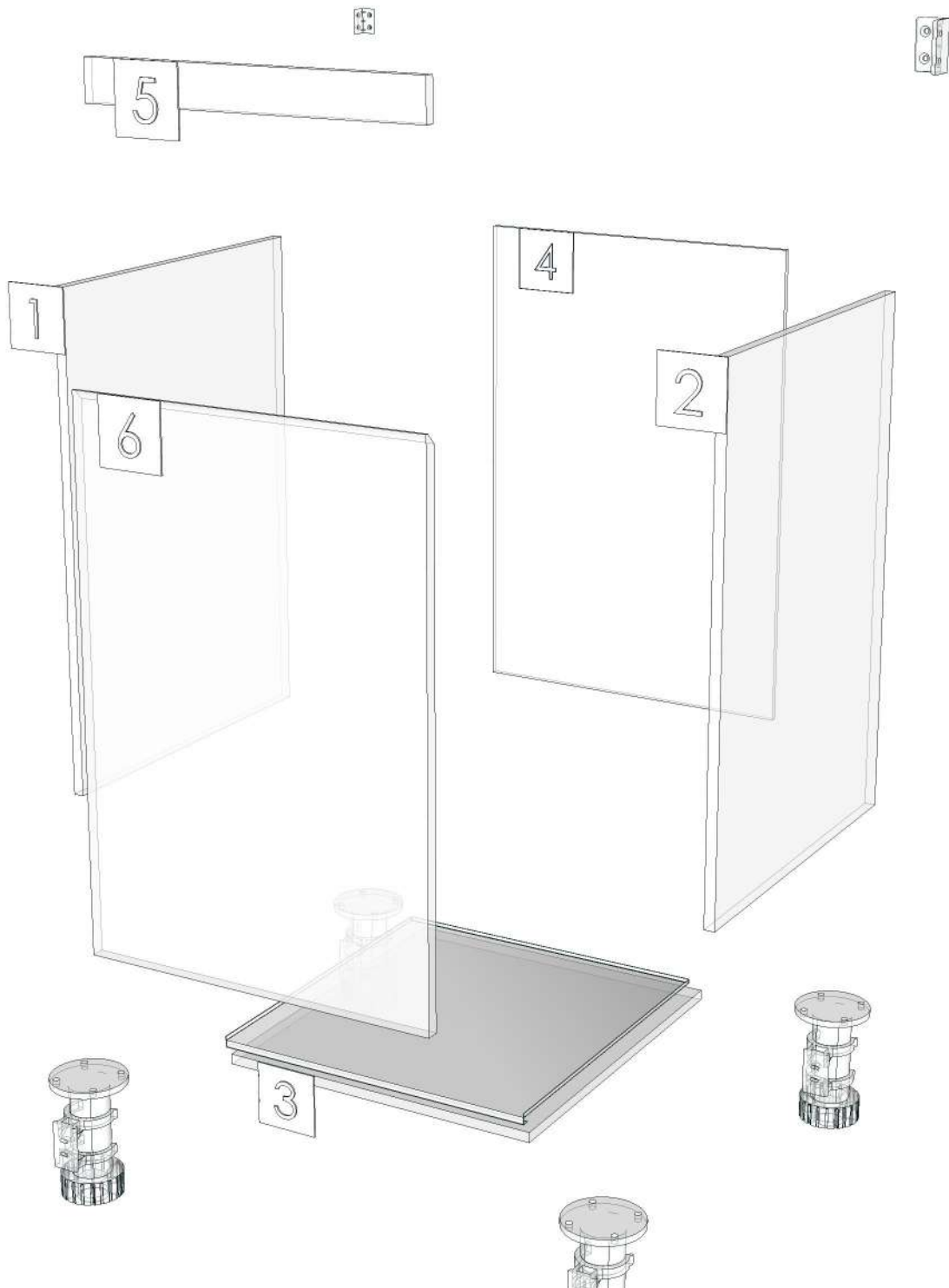

<b>Model</b>	THE_NEXT_RC_DL60HR		
<b>Creator</b>	CHALEAMPHON	<b>.BCP Name</b>	INDEX_C3D_KITCHEN2
<b>Reviewer</b>		<b>Order</b>	H000766
<b>Approves</b>		<b>Date</b>	21/12/2023

## **THE\_NEXT\_RC\_DL60HR-600X300X600**

### **Colour**

20.46=ML.GREY MK3238 (PEARL)

20.56=ML.GREY MK3238 (MATT)

### **Edge**

01.227=1 LIGHT SAND GRAY-8E960M1

01.347=1 MK3238 HI-GROSS:102165 HG

<b>R&amp;D REVIEW</b>	
<input checked="" type="checkbox"/>	DWG.Customer
<input checked="" type="checkbox"/>	Work Report
<input type="checkbox"/>	Function
<input type="checkbox"/>	สินค้าตรงตัวอย่าง
ผู้ทบทวน <u>P.SAWAI</u>	
<u>21/12/23</u>	

K101L-160134095

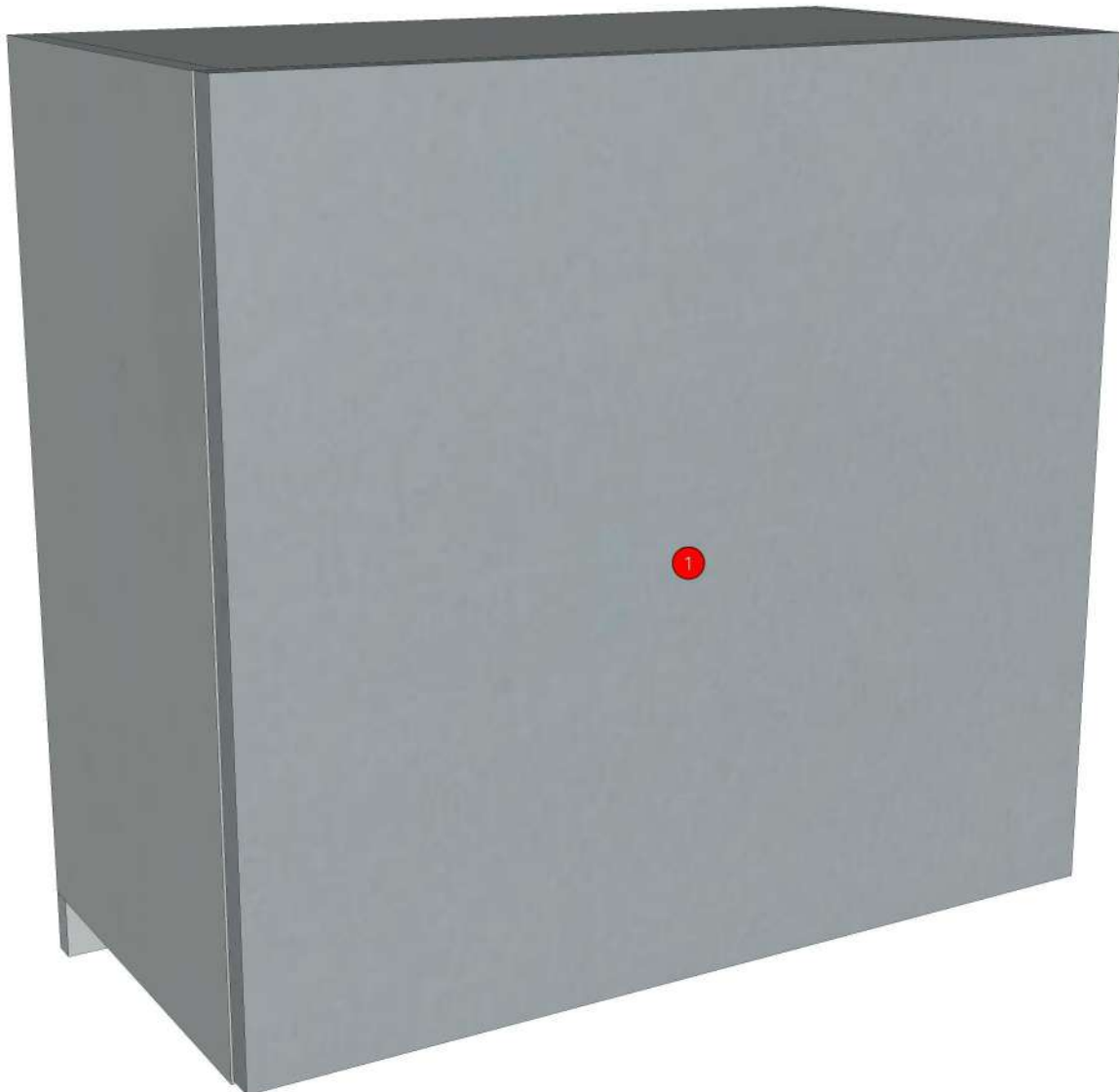

<b>Model</b>	-THE_NEXT_RC		
<b>Creator</b>	CHALEAMPHON	<b>.BCP Name</b>	INDEX_C3D_KITCHEN2
<b>Reviewer</b>		<b>Order</b>	H000766
<b>Approves</b>		<b>Date</b>	21/12/2023

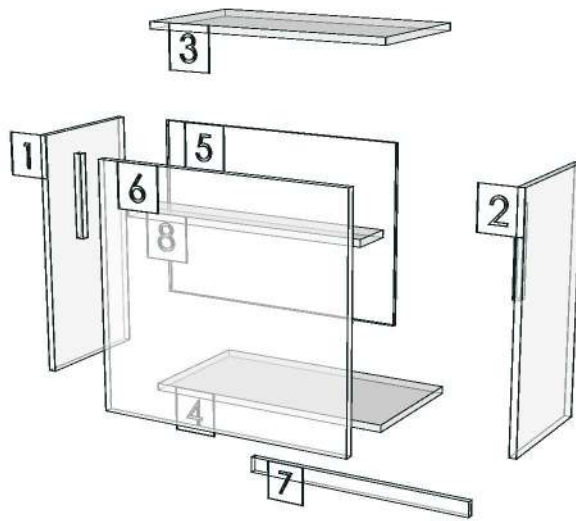

<b>Model</b>	NEXT_1_DLO75L		
<b>Creator</b>	CHALEAMPON	<b>.BCP Name</b>	INDEX_C3D_KITCHEN2
<b>Reviewer</b>		<b>Order</b>	H000787
<b>Approves</b>		<b>Date</b>	25/01/2024

## **NEXT\_1\_DLO75L-750X300X500**

### **Colour**

20.46=ML.GREY MK3238 (PEARL)  
20.56=ML.GREY MK3238 (MATT)

### **Edge**

01.227=1 LIGHT SAND GRAY-8E960M1  
01.347=1 MK3238 HI-GROSS:102165 HG

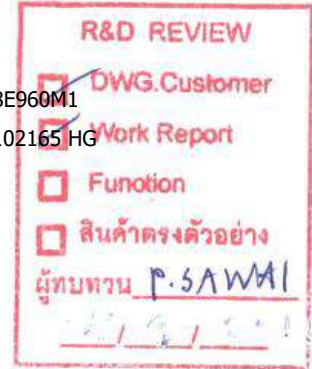

K100L-160134574



<b>Model</b>	-NEXT_1		
<b>Creator</b>	CHALEAMPON	<b>.BCP Name</b>	INDEX_C3D_KITCHEN2
<b>Reviewer</b>		<b>Order</b>	H000787
<b>Approves</b>		<b>Date</b>	25/01/2024

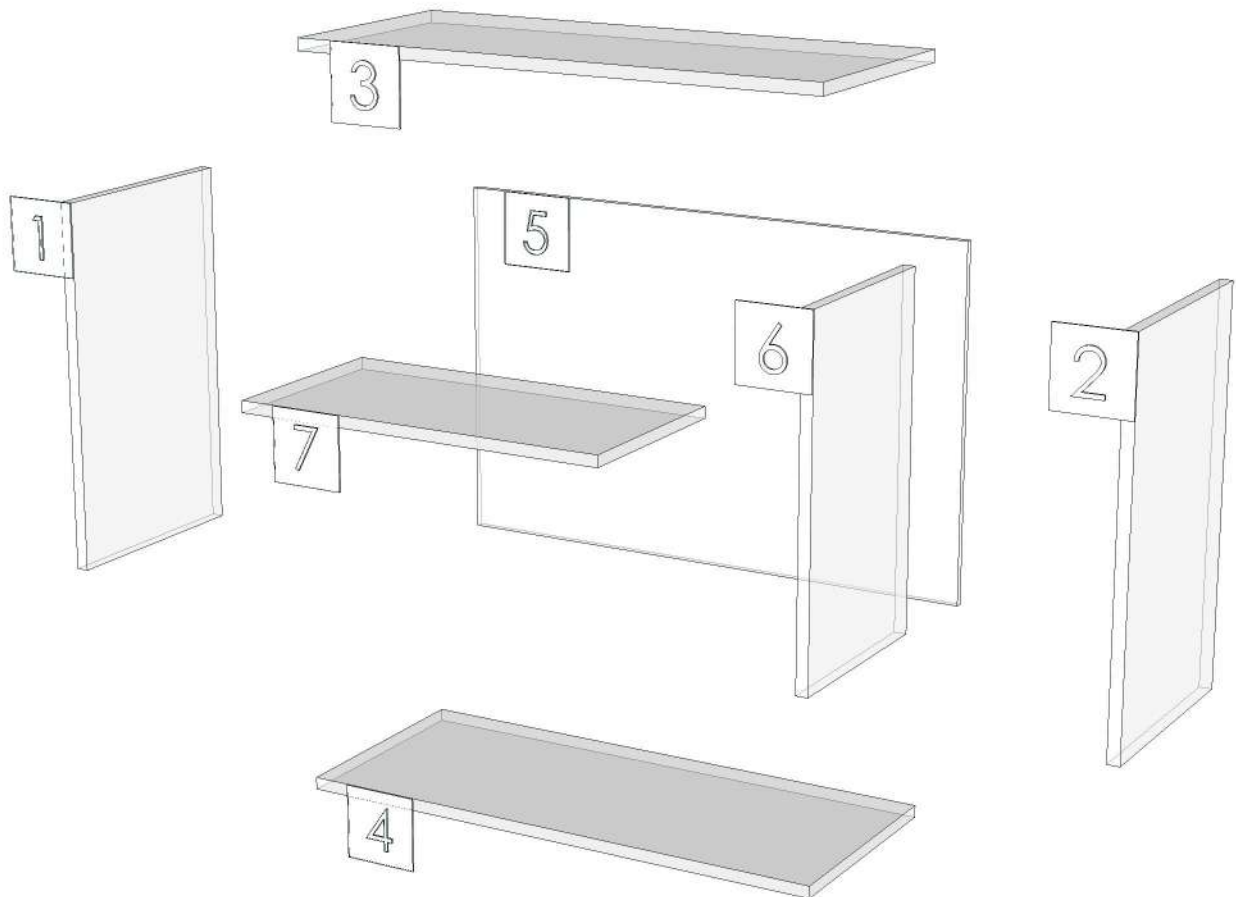

<b>Model</b>	NEXT_1_DDM75		
<b>Creator</b>	CHALEAMPON	<b>.BCP Name</b>	INDEX_C3D_KITCHEN2
<b>Reviewer</b>		<b>Order</b>	H000437
<b>Approves</b>		<b>Date</b>	21/12/2023

## NEXT\_1\_DDM75-750X16X100

**Colour**

20.56=ML.GREY MK3238 (MATT)

**Edge**

01.347=1 MK3238 HI-GROSS:102165 HG

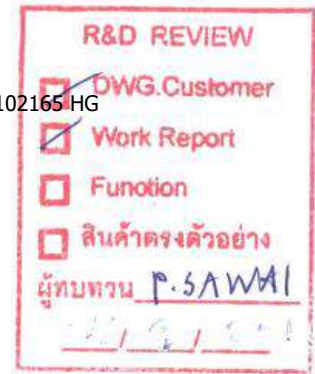

K100L-160134574

K100R-160121016

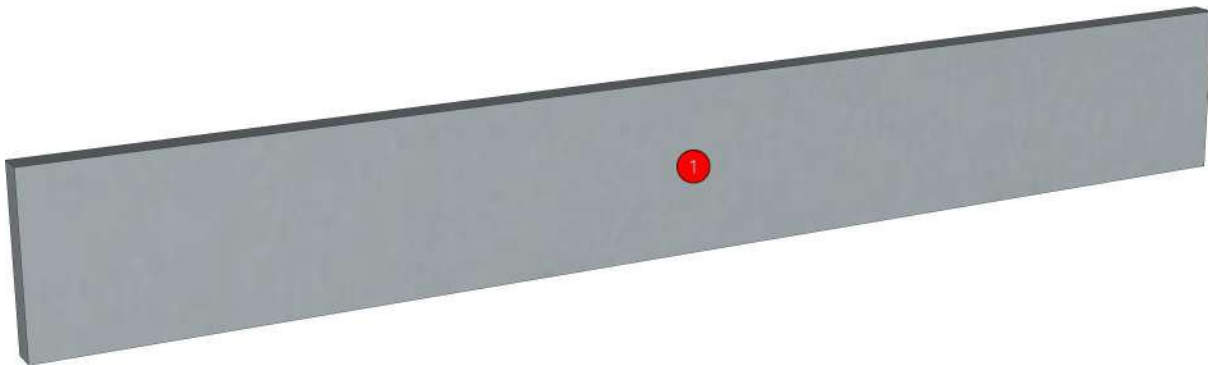

<b>Model</b>	NEXT_1_DFB		
<b>Creator</b>	CHALEAMPHON	<b>.BCP Name</b>	INDEX_C3D_KITCHEN2
<b>Reviewer</b>		<b>Order</b>	H000440
<b>Approves</b>		<b>Date</b>	21/12/2023

## NEXT\_1\_DFB-150X570X788

### Colour

20.46=ML.GREY MK3238 (PEARL)

20.56=ML.GREY MK3238 (MATT)

### Edge

01.227=1 LIGHT SAND GRAY-8E960M1

01.347=1 MK3238 HI-GROSS:102165 HG

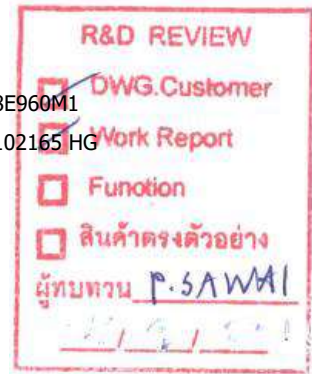

K100L-160134574

K100R-160121016

K102-160134591

K103-160134601







