

Model	REFERENCE_DBSC10060L		
Creator	PASATHORN	.BCP Name	INDEX_C3D_KITCHEN2
Reviewer		Order	I002783
Approves	P-SAWAI	Date	15/11/2023

REFERENCE_DBSC10060L-1000X570X888**Colour**

02.43=FOIL AP7 AQ-152-12KBWG (AQ PAPER)

03.13=PVC WHITE#630 T0.15MM.

Edge

01.255=1 RHODES AP7



K103R-160131196



Model	-REFERENCE_DBSC10060L		
Creator		.BCP Name	INDEX_C3D_KITCHEN2
Reviewer		Order	1002783
Approves		Date	

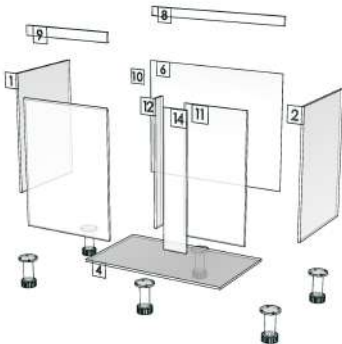

Model	REFERENCE_DBH602		
Creator	PASATHORN	.BCP Name	INDEX_C3D_KITCHEN2
Reviewer		Order	I002425
Approves	P. SAWAI	Date	30/06/2023

REFERENCE_DBH602-600X570X888

Colour

02.43=FOIL AP7 AQ-152-12KBWG (AQ PAPER)

20.56=ML GREY MK3238 (MATT)

20.07=ML AE9V (MATT)

03.13=PVC WHITE#630 T0.15MM.

K100L-160131166

K112L-160123160

K101L-160131176

K102L-160131186

K117L-160123170

K102R-160123111

K118R-160131219

K103R-160131196

K122L-160123183

K105R-160131209

K123L-160123193

K108L-160123120

K123R-160123203

K108R-160123129

K125R-160131232

K109R-160123138

K126R-160131546

K110R-160123152

Edge

01.255=1 RHODES AP7

01.47=1 WHITE



ปิดขอบด้วยกาว PUR

Model	-REFERENCE_DBH602	.BCP Name	INDEX_C3D_KITCHEN2
Creator		Order	I002425
Reviewer		Date	
Approves			

17

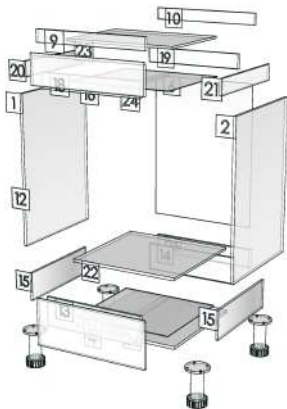

Model	REFERENCE_DL60RSL		
Creator	PASATHORN	.BCP Name	INDEX_C3D_KITCHEN2
Reviewer		Order	I002419
Approves	P. SAWAI	Date	29/06/2023

REFERENCE_DL60RSL-600X350X800

Colour

02.43=FOIL AP7 AQ-152-12KBWG (AQ PAPER)

03.13=PVC WHITE#630 T0.15MM.

20.24=ML AE9V (PEARL)

Edge

01.255=1 RHODES AP7

01.47=1 WHITE



K103R-160131196

K105R-160131209

K108R-160123129

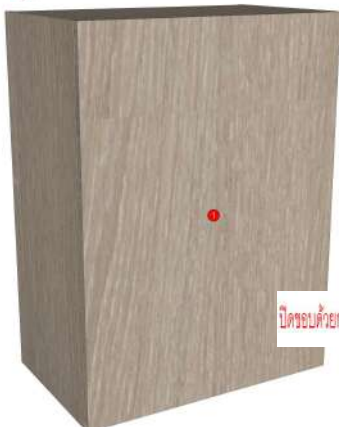

ปิดขอบด้วยกาว PUR

Model	-REFERENCE_DL60RSL	.BCP Name	INDEX_C3D_KITCHEN2
Creator		Order	I002419
Reviewer		Date	
Approves			

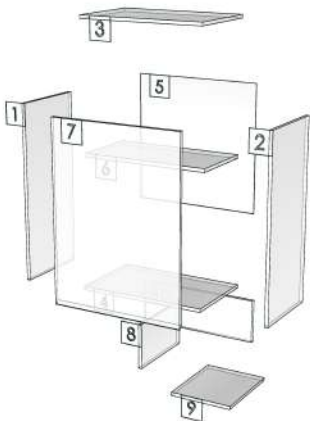

Model	REFERENCE_DLC6029R		
Creator	PASATHORN	.BCP Name	INDEX_C3D_KITCHEN2
Reviewer		Order	1002782
Approves		Date	15/11/2023

REFERENCE_DLC6029R-735X350X800**Colour**

02.43=FOIL AP7 AQ-152-12KBWG (AQ PAPER)

03.13=PVC WHITE#630 T0.15MM.

20.24=ML AE9V (PEARL)

Edge

01.255=1 RHODES AP7

01.47=1 WHITE

K103R-160131196



Model	-REFERENCE_DLC6029R		
Creator		.BCP Name	INDEX_C3D_KITCHEN2
Reviewer		Order	I002782
Approves		Date	

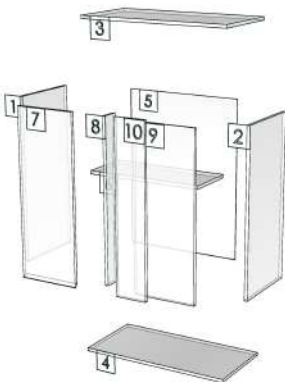

Model	REFERENCE_DBO74GL		
Creator	PASATHORN	.BCP Name	INDEX_C3D_KITCHEN2
Reviewer		Order	I002765
Approves		Date	13/11/2023

REFERENCE_DBO74GL-740X600X888**Colour**

02.43=FOIL AP7 AQ-152-12KBWG (AQ PAPER)

Edge

01.255=1 RHODES AP7

K103R-160131196



Model	-REFERENCE_DBO74GL		
Creator		.BCP Name	INDEX_C3D_KITCHEN2
Reviewer		Order	I002765
Approves		Date	

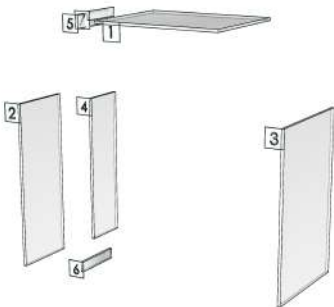

Model	REFERENCE_DL60HLS		
Creator	PASATHORN	.BCP Name	INDEX_C3D_KITCHEN2
Reviewer		Order	I002414
Approves	P-SAWAI	Date	29/06/2023

REFERENCE_DL60HLS-600X350X755

Colour

02.43=FOIL AP7 AQ-152-12KBWG (AQ PAPER)
03.13=PVC WHITE#630 T0.15MM.
20.24=ML AE9V (PEARL)

Edge

01.255=1 RHODES AP7
01.47=1 WHITE

R&D REVIEW	
<input checked="" type="checkbox"/>	Draw Customer
<input checked="" type="checkbox"/>	Visit Report
<input type="checkbox"/>	Function
<input type="checkbox"/>	สีไม้/กระดาษ/กระดาษ
ผู้ตรวจ P-SAWAI	

K102R-160123111
K103R-160131196
K105R-160131209
K108R-160123129
K110R-160123152

K117L-160123170
K118R-160131219
K123R-160123203
K125R-160131232

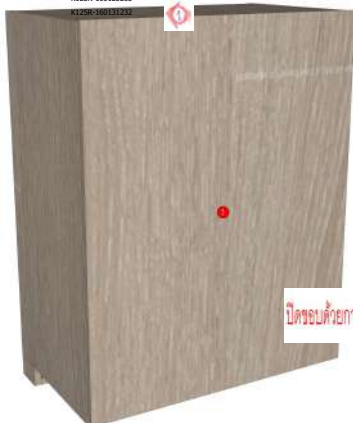

ปิดขอบด้วยกาว PUR

Model	-REFERENCE_DL60HLS		
Creator		.BCP Name	INDEX_C3D_KITCHEN2
Reviewer		Order	I002414
Approves		Date	

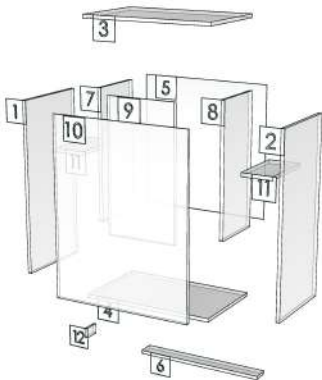

Model	REFERENCE_DL30L		
Creator	PASATHORN	.BCP Name	INDEX_C3D_KITCHEN2
Reviewer		Order	I002750
Approves	P.SAWMI	Date	11/11/2023

REFERENCE_DL30L-300X350X800

Colour

02.43=FOIL AP7 AQ-152-12KBWG (AQ PAPER)

03.13=PVC WHITE#630 T0.15MM.

20.24=ML AE9V (PEARL)

Edge

01.255=1 RHODES AP7

01.47=1 WHITE



K103R-160131196



ปิดขอบด้วยกาว PUR

Model	-REFERENCE_DL30L		
Creator		.BCP Name	INDEX_C3D_KITCHEN2
Reviewer		Order	1002750
Approves		Date	

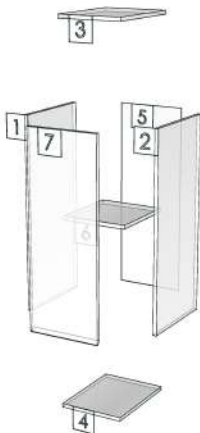

Model	REFERENCE_DL60		
Creator	PASATHORN	.BCP Name	INDEX_C3D_KITCHEN2
Reviewer		Order	I002753
Approves		Date	11/11/2023

REFERENCE_DL60-600X350X800

Colour

02.43=FOIL AP7 AQ-152-12KBWG (AQ PAPER)

03.13=PVC WHITE#630 T0.15MM.

20.24=ML AE9V (PEARL)

Edge

01.255=1 RHODES AP7

01.47=1 WHITE

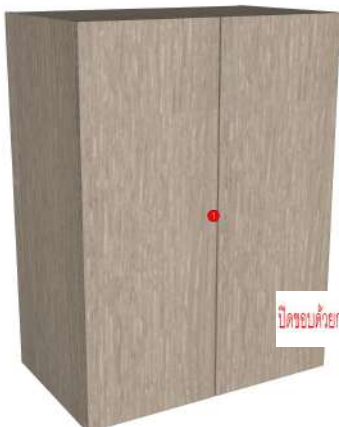

ปิดขอบด้วยกาา PUR

Model	-REFERENCE_DL60		
Creator		.BCP Name	INDEX_C3D_KITCHEN2
Reviewer		Order	I002753
Approves		Date	

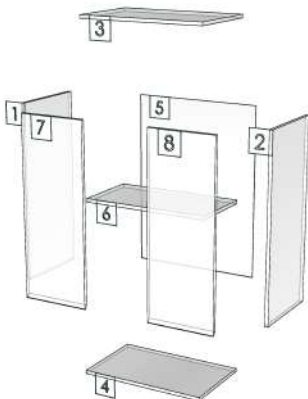

Model	REFERENCE_DW75		
Creator	PASATHORN	.BCP Name	INDEX_C3D_KITCHEN2
Reviewer		Order	I002773
Approves	P. (AWA)	Date	14/11/2023

REFERENCE_DW75-750X350X500

Colour

02.43=FOIL AP7 AQ-152-12KBWG (AQ PAPER)
03.13=PVC WHITE#630 T0.15MM.
20.24=ML AE9V (PEARL)

Edge

01.255=1 RHODES AP7
01.47=1 WHITE



K103R-160131196



Model	-REFERENCE_DW75		
Creator		.BCP Name	INDEX_C3D_KITCHEN2
Reviewer		Order	I002773
Approves		Date	

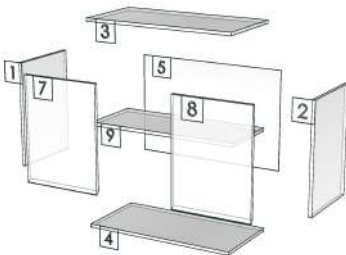

Model	REFERENCE_DDM1950		
Creator	PASATHORN	.BCP Name	INDEX_C3D_KITCHEN2
Reviewer		Order	I002556
Approves		Date	06/09/2023

REFERENCE_DDM1950-1950X6X550**Colour**

03.13=PVC WHITE#630 T0.15MM.

Edge

=

K112L-160123160

K103R-160131196

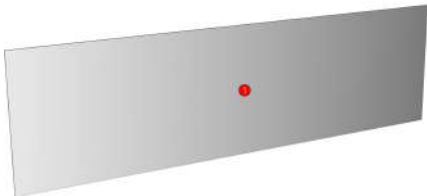

Model	REFERENCE_DDM1350		
Creator	PASATHORN	.BCP Name	INDEX_C3D_KITCHEN2
Reviewer		Order	I002741
Approves	P. SAWAI	Date	09/11/2023

REFERENCE_DDM1350-1350X6X550

Colour

03.13=PVC WHITE#630 TO.15MM.

Edge

=



K103R-160131196

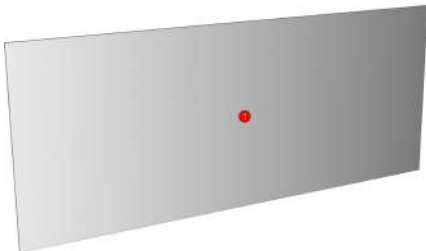

Model	REFERENCE_DFL		
Creator	PASATHORN	.BCP Name	INDEX_C3D_KITCHEN2
Reviewer		Order	I002377
Approves	P. SAWAI	Date	21/06/2023

REFERENCE_DFL-150X15X800

Colour

02.43=FOIL AP7 AQ-152-12KBWG (AQ PAPER)

Edge

01.255=1 RHODES AP7

K101L-160131176

K112L-160123160

K113L-160134022

K114L-160129206

K117L-160123170

K126R-160131546

K103R-160131196

K118R-160131219

K122L-160123183

K123L-160123193

K123R-160123203

K109R-160123138

K124R-160134041

K110R-160123152



ปิดขอบด้วยกาว PUR

Model	-REFERENCE_DFL		
Creator		.BCP Name	INDEX_C3D_KITCHEN2
Reviewer		Order	I002377
Approves		Date	



Model	REFERENCE_DFW		
Creator	PASATHORN	.BCP Name	INDEX_C3D_KITCHEN2
Reviewer		Order	I002378
Approves	P.SAWA	Date	21/06/2023

REFERENCE_DFW-150X15X500

Colour

02.43=FOIL AP7 AQ-152-12KBWG (AQ PAPER)

Edge

01.255=1 RHODES AP7

R&D REVIEW

DWG Customer

Work Report

Function

ไม้ลามิเนตสีน้ำตาล

ผู้ตรวจ P.SAWA

K102L-160131186

K102R-160123111

K103R-160131196

K118R-160131219

K109R-160123138

K126R-160131546



ปิดขอบด้วยกาว PUR

Model	-REFERENCE_DFW		
Creator		.BCP Name	INDEX_C3D_KITCHEN2
Reviewer		Order	I002378
Approves		Date	

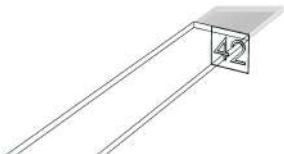

Model	REFERENCE_DF_CL2430		
Creator	PASATHORN	.BCP Name	INDEX_C3D_KITCHEN2
Reviewer		Order	I002696
Approves	P-SAWAI	Date	17/10/2023

REFERENCE_DF_CL2430-2430X12X150

Colour

02.43=FOIL AP7 AQ-152-12KBWG (AQ PAPER)

Edge

01.255=1 RHODES AP7

R&D REVIEW	
<input checked="" type="checkbox"/>	Draw Customer
<input checked="" type="checkbox"/>	Work Report
<input type="checkbox"/>	Function
<input type="checkbox"/>	สินค้าที่ส่งมอบ
ผู้ตรวจ P-SAWAI	

K114L-160129206

K103R-160131196

K124R-160134041



ปิดขอบด้วยกาว PUR

Model	REFERENCE_DF_CL1000		
Creator	PASATHORN	.BCP Name	INDEX_C3D_KITCHEN2
Reviewer		Order	I002734
Approves	P. SAWAI	Date	07/11/2023

REFERENCE_DF_CL1000-1000X12X150

Colour

02.43=FOIL AP7 AQ-152-12KBWG (AQ PAPER)

Edge

01.255=1 RHODES AP7



K103R-160131196



ปิดขอบด้วยกาว PUR

Model	REFERENCE_DF_CL350		
Creator	PASATHORN	.BCP Name	INDEX_C3D_KITCHEN2
Reviewer		Order	I002367
Approves	P.SAWMI	Date	20/06/2023

REFERENCE_DF_CL350-350X12X150

Colour

02.43=FOIL AP7 AQ-152-12KBWG (AQ PAPER)

Edge

01.255=1 RHODES AP7



K100L-160131166
K101L-160131176
K102L-160131186
K102R-160123111
K103R-160131196
K105R-160131209
K108L-160123120
K108R-160123129
K109R-160123138
K110R-160123152

K112L-160123160
K113-160134022
K114L-160129206
K117L-160123170
K118R-160131219
K122L-160123183
K123L-160123193
K123R-160123203
K124R-160134041
K125R-160131232

K126R-160131546



ปิดขอบด้วยกาว PUR

Model	REFERENCE_D_PLT1400		
Creator	PASATHORN	.BCP Name	INDEX_C3D_KITCHEN2
Reviewer		Order	I002728
Approves	P.SAWA	Date	07/11/2023

REFERENCE_D_PLT1400-1400X12X100

Colour

02.43=FOIL AP7 AQ-152-12KBWG (AQ PAPER)

Edge

01.255=1 RHODES AP7



K103R-160131196



ปิดขอบด้วยกาว PUR

Model	REFERENCE_D_PLT600		
Creator	PASATHORN	.BCP Name	INDEX_C3D_KITCHEN2
Reviewer		Order	I002357
Approves	P.SAWMI	Date	16/06/2023

REFERENCE_D_PLT600-600X12X100

Colour

02.43=FOIL AP7 AQ-152-12KBWG (AQ PAPER)

Edge

01.255=1 RHODES AP7



K100L-160131166
K101L-160131176
K102L-160131186
K102R-160123111
K103R-160131196
K105R-160131209
K108L-160123120
K108R-160123129
K109R-160123138
K110R-160123152

K112L-160123160
K113-160134022
K114L-160129206
K117L-160123170
K118R-160131219
K122L-160123183
K123L-160123193
K123R-160123203
K124R-160134041
K125R-160131232

K126R-160131546

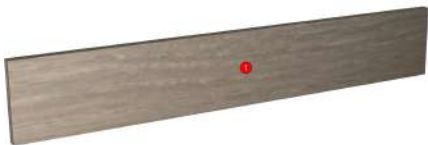

ปิดขอบด้วยกาว PUR