

Model	RHYTHM_EK_D_PLINT_900(F)		
Creator	YUTHAPONG	.BCP Name	INDEX_C3D_KITCHEN2
Reviewer		Order	F000699
Approves		Date	26/02/2021

RHYTHM_EK_D_PLINT_900(F)-900X9X100

Colour

20.27=ML ML MD519 (EVELYN)

Edge

01.240=1MM MD519

R&D REVIEW	
<input type="checkbox"/>	DWG.Customer
<input type="checkbox"/>	Work Report
<input type="checkbox"/>	Function
<input type="checkbox"/>	สินค้าตรงตัวอย่าง
ผู้ทบทวน _____	

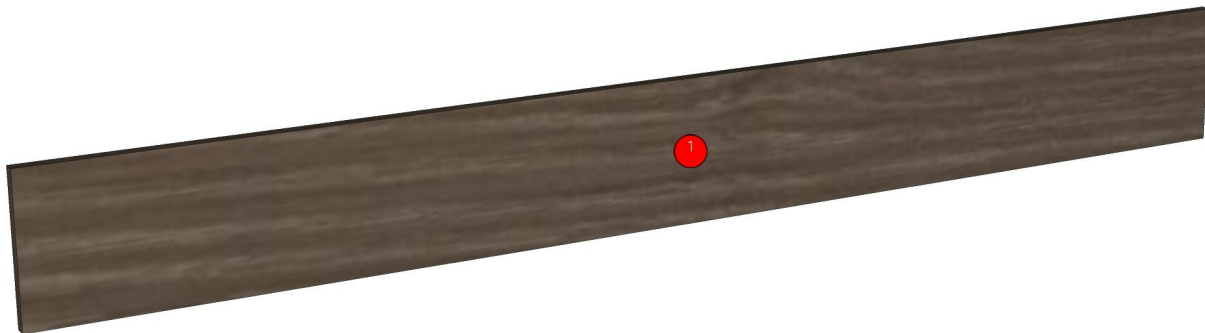

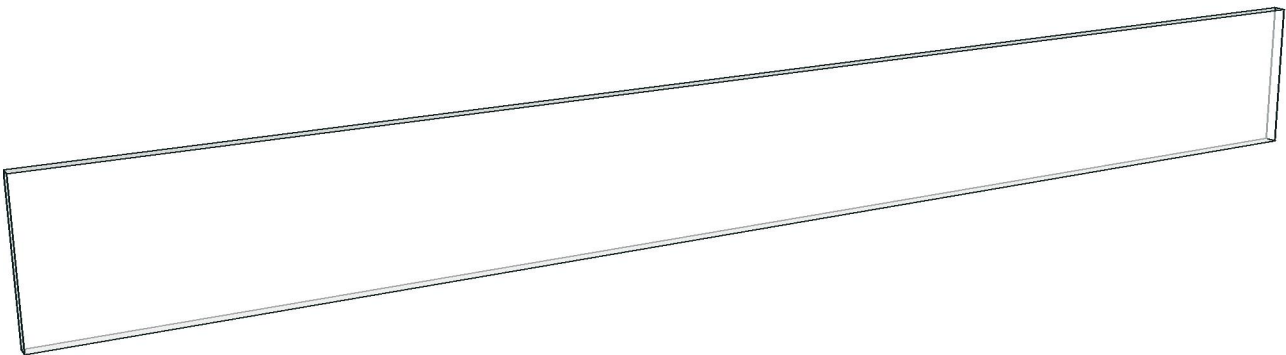
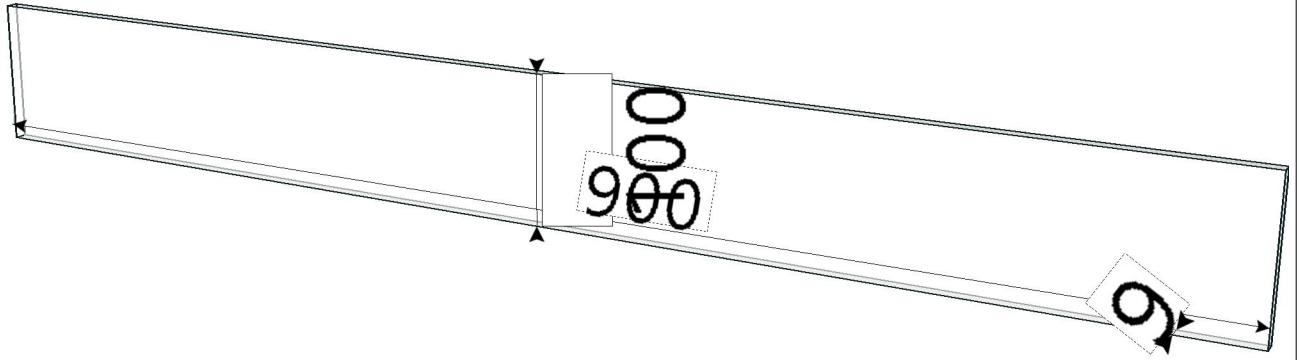

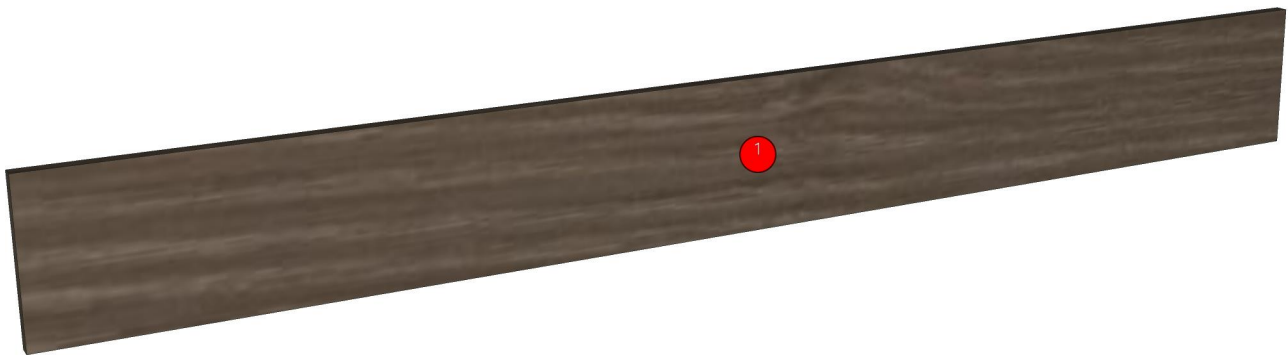
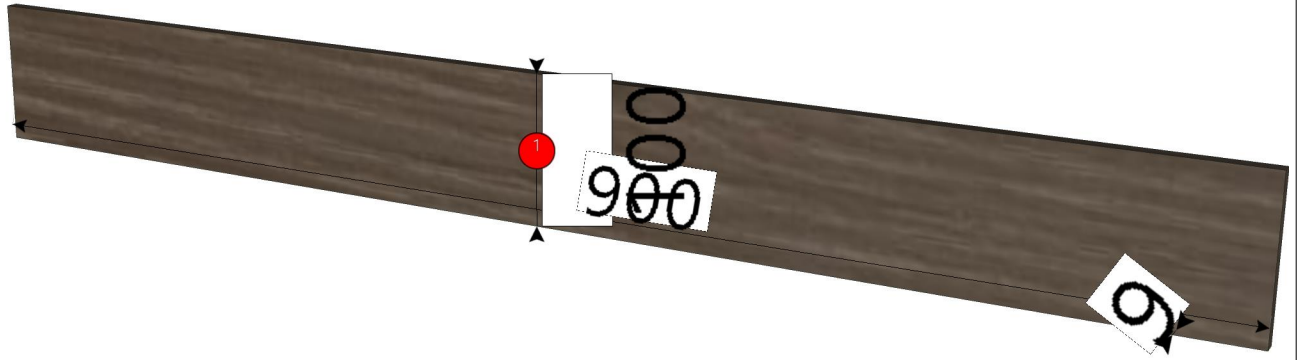

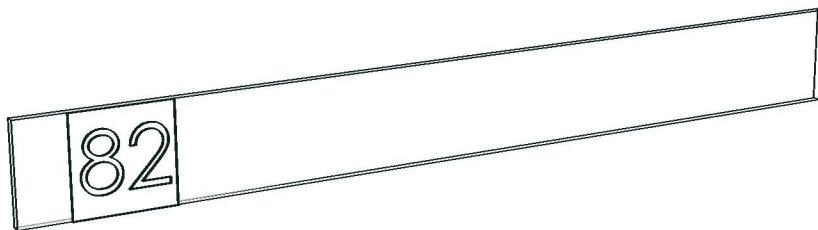
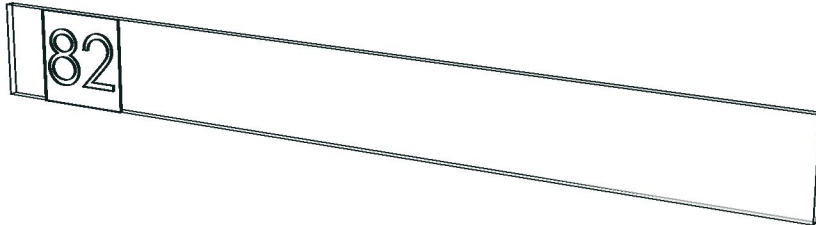

Model	RHYTHM_EK_D_PLINT_900(F)		
Creator	YUTHAPONG	.BCP Name	INDEX_C3D_KITCHEN2
Reviewer		Order	F000699
Approves		Date	26/02/2021

No.	Article No.	Description	Mat	Dimension	Cutting Size	Typepology	Skin
0	RHYTHM_EK_D_PLINT_900(F)			900x100x9			
	RHYTHM_EK_D_PLINT_900(F)-0-82	PLINT	PB-SP	9x100x900	9X99X898;L1:W2	582000 _STR=20.27 _EDG=MD519-1	2

FITTING LIST

Qty per 1 set

No	New	Article fitting	List	Connect	Qty/Pcs				Cost / Qty	Sum Cost
					Spray	Ass	Pack	Sum		
0		RHYTHM_EK_D_PLINT_900(F)		900x100x9						

No	Date	REVISION RECORD	REMARK	Create	YUTHAPONG	date:26/02/2021	Product name : -
4				Revivewer		date:	Article: TYPE:
3				Approves		date:	
2				Design			Customer: Indexlivingmall
1	26/02/2021	First departure		Name&Art			No:
<p>INTERFURN INDEX INTERFURN CO.LTD Document control FR-RD-004 : REV#00:24/04/60</p>							