

<b>Model</b>	RHYTHM_EK_D_PLINT_600(F)		
<b>Creator</b>	YUTHAPONG	<b>.BCP Name</b>	INDEX_C3D_KITCHEN2
<b>Reviewer</b>		<b>Order</b>	F000696
<b>Approves</b>		<b>Date</b>	26/02/2021

## **RHYTHM\_EK\_D\_PLINT\_600(F)-600X9X100**

**Colour**

20.27=ML ML MD519 (EVELYN)

**Edge**

01.240=1MM MD519

<b>R&amp;D REVIEW</b>	
<input type="checkbox"/>	DWG.Customer
<input type="checkbox"/>	Work Report
<input type="checkbox"/>	Function
<input type="checkbox"/>	สินค้าตรงตัวอย่าง
ผู้ทบทวน _____	
_____	

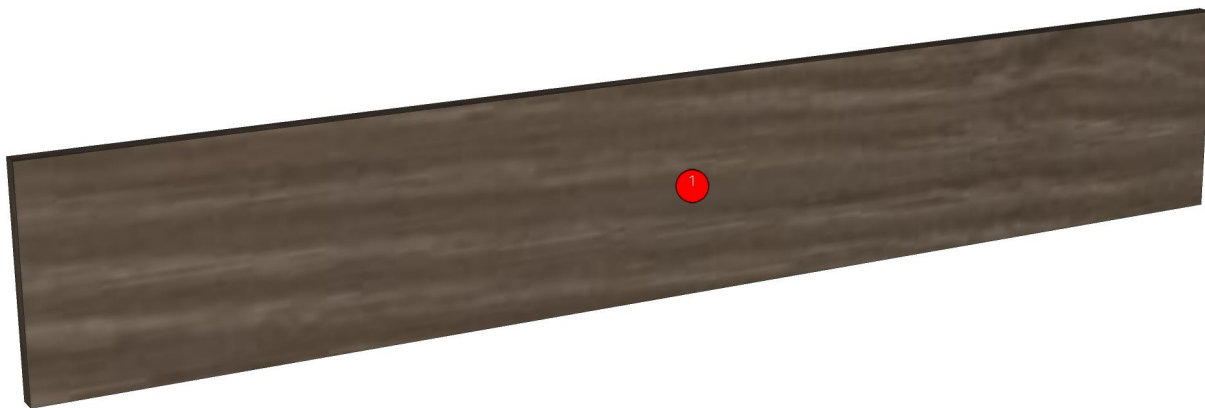

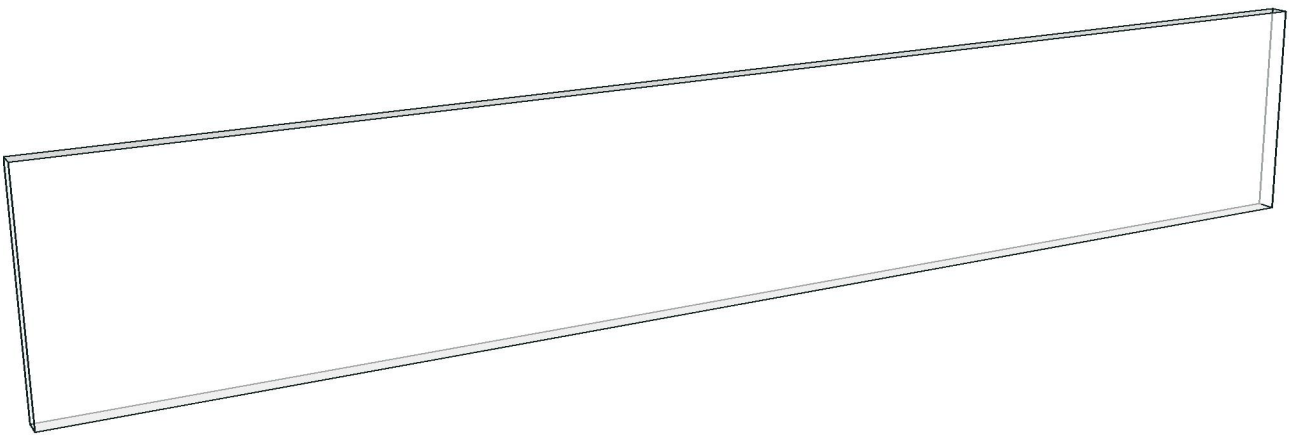
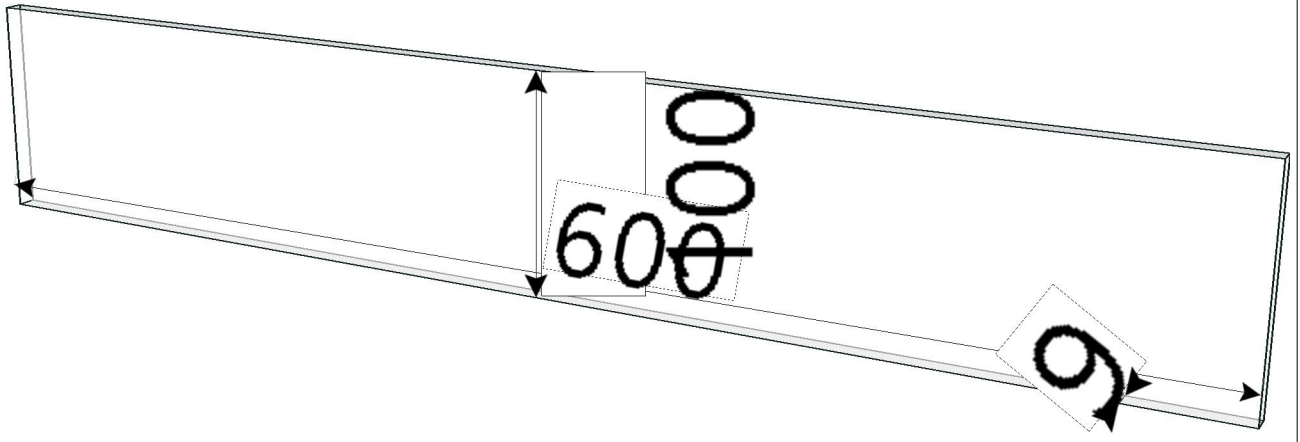

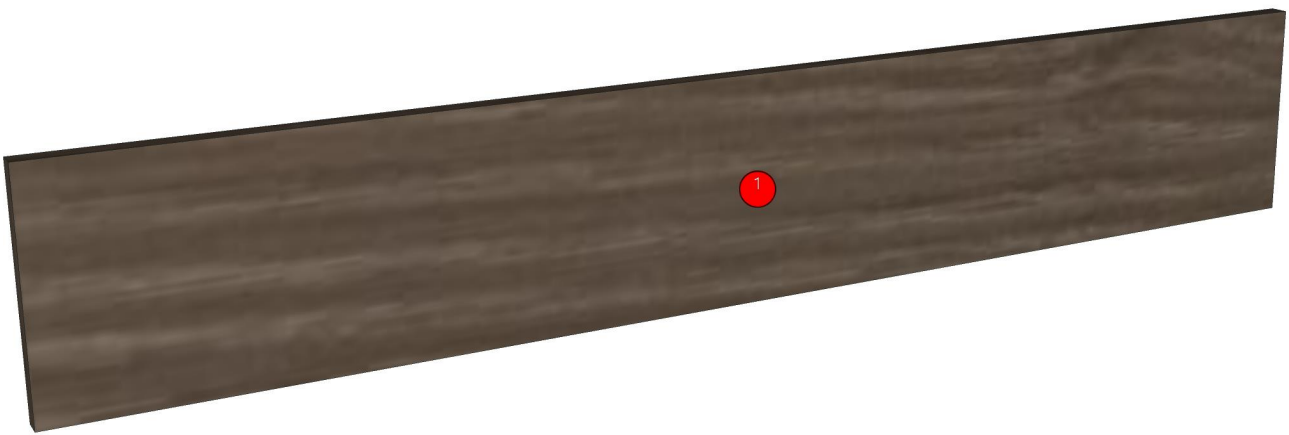
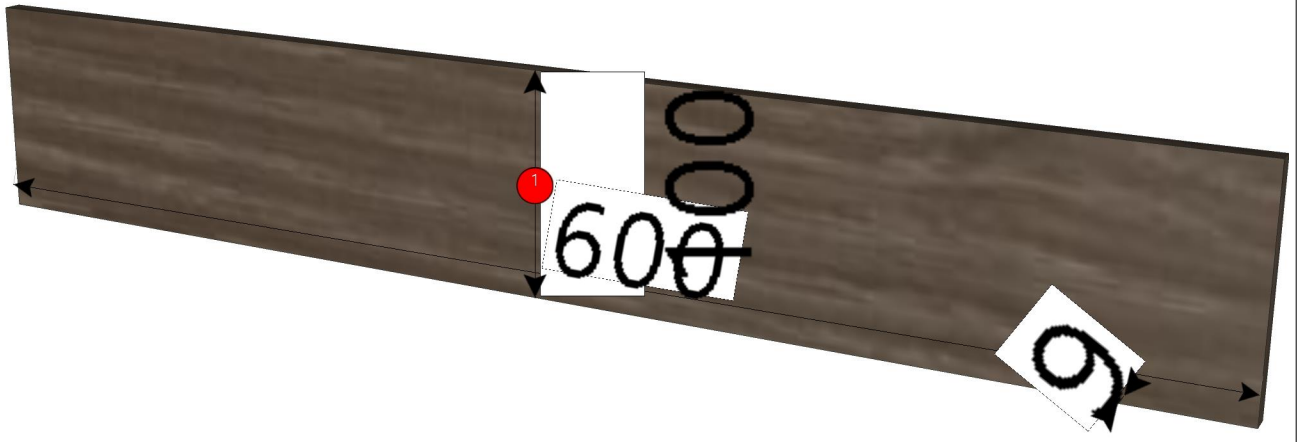

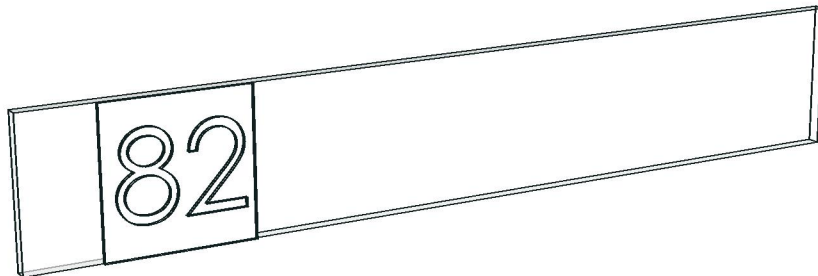
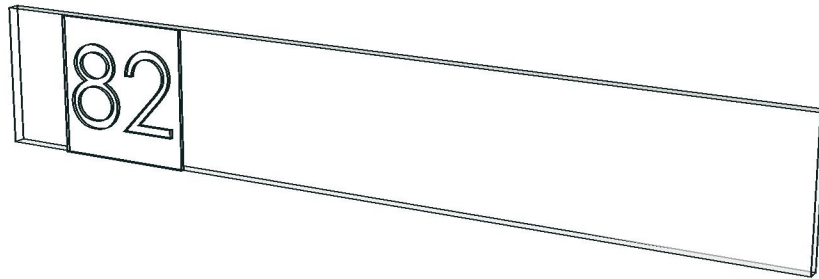

<b>Model</b>	RHYTHM_EK_D_PLINT_600(F)		
<b>Creator</b>	YUTHAPONG	<b>.BCP Name</b>	INDEX_C3D_KITCHEN2
<b>Reviewer</b>		<b>Order</b>	F000696
<b>Approves</b>		<b>Date</b>	26/02/2021

No.	Article No.	Description	Mat	Dimension	Cutting Size	Typepology	Skin
0	RHYTHM_EK_D_PLINT_600(F)			600x100x9			
	RHYTHM_EK_D_PLINT_600(F)-0-82	PLINT	PB-SP	9x100x600	9X99X598;L1:W2	582000 _STR=20.27 _EDG=MD519-1	2

# FITTING LIST

Qty per 1 set

No	New	Article fitting	List	Connect	Qty/Pcs					Sum Cost
					Spray	Ass	Pack	Sum	Cost / Qty	
0		RHYTHM_EK_D_PLINT_600(F)		600x100x9						

No	Date	REVISION RECORD	REMARK	Create	YUTHAPONG	date:26/02/2021	Product name : -
4				Revivewer		date:	Article: TYPE:
3				Approves		date:	
2				Design			Customer: Indexlivingmall
1	26/02/2021	First departure		Name&Art			No:
<p><b>INTERFURN</b> INDEX INTERFURN CO.LTD Document control FR-RD-004 : REV#00:24/04/60</p>							