

<b>Model</b>	RHYTHM_EK_D_PLINT_1200		
<b>Creator</b>	YUTHAPONG	<b>.BCP Name</b>	INDEX_C3D_KITCHEN2
<b>Reviewer</b>		<b>Order</b>	F000684
<b>Approves</b>		<b>Date</b>	26/02/2021

## **RHYTHM\_EK\_D\_PLINT\_1200-1200X9X100**

**Colour**

20.27=ML ML MD519 (EVELYN)

**Edge**

01.240=1MM MD519

<b>R&amp;D REVIEW</b>	
<input type="checkbox"/>	DWG.Customer
<input type="checkbox"/>	Work Report
<input type="checkbox"/>	Function
<input type="checkbox"/>	สินค้าตรงตัวอย่าง
ผู้ทบทวน _____	
_____	

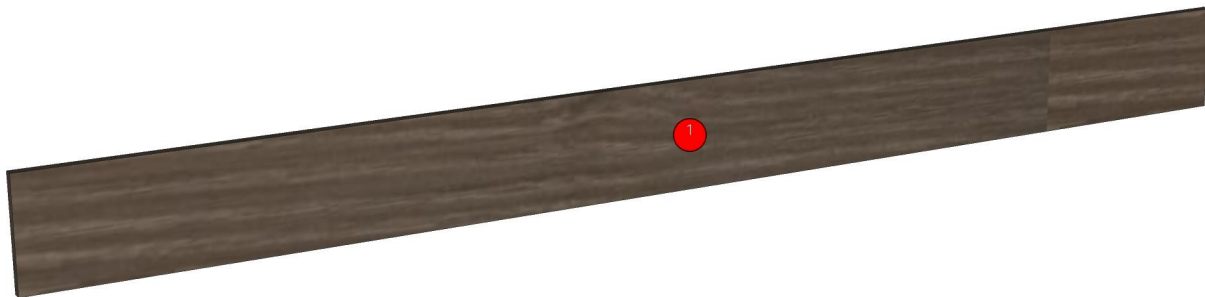

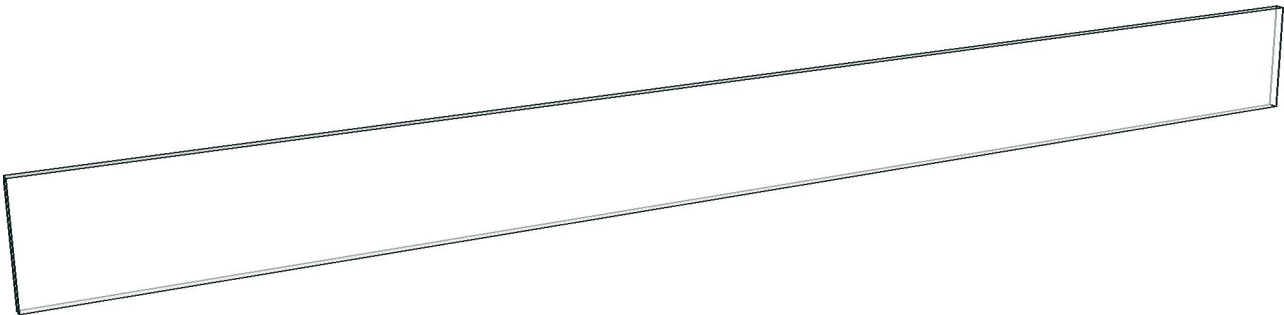
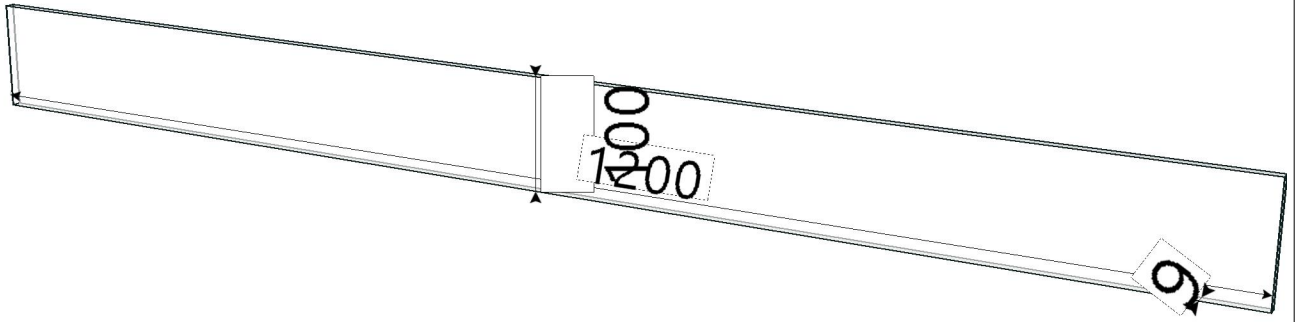

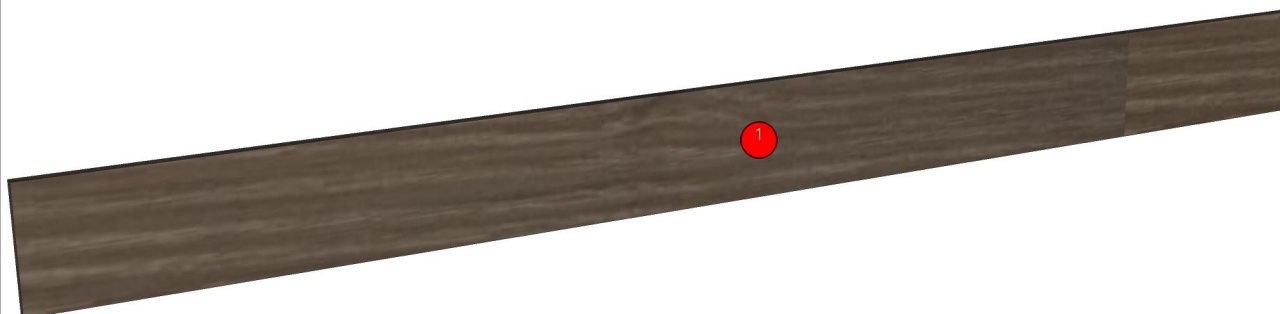
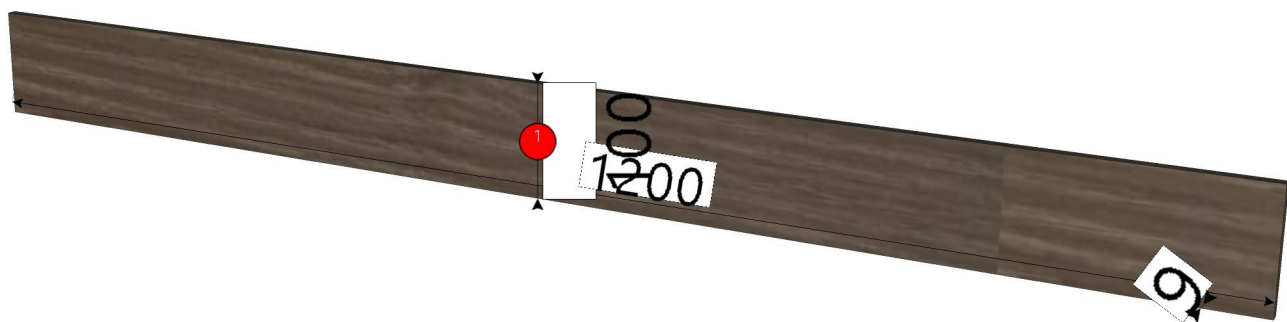

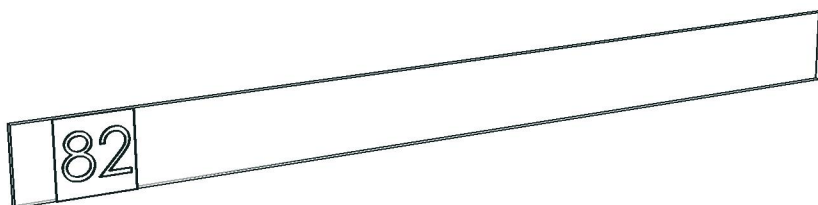
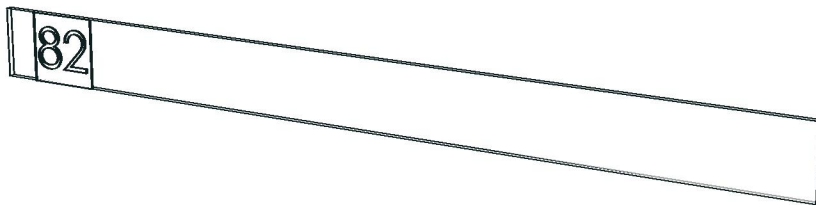

<b>Model</b>	RHYTHM_EK_D_PLINT_1200		
<b>Creator</b>	YUTHAPONG	<b>.BCP Name</b>	INDEX_C3D_KITCHEN2
<b>Reviewer</b>		<b>Order</b>	F000684
<b>Approves</b>		<b>Date</b>	26/02/2021

No.	Article No.	Description	Mat	Dimension	Cutting Size	Typepology	Skin
0	RHYTHM_EK_D_PLINT_1200			1200x100x9			
	RHYTHM_EK_D_PLINT_1200-0-82	PLINT	PB-SP	9x100x1200	9X99X1199;L1:W1	582000 _STR=20.27 _EDG=MD519-1	2

