

Model	RHYTHM_EK_D_PLINT_1050		
Creator	YUTHAPONG	.BCP Name	INDEX_C3D_KITCHEN2
Reviewer		Order	F000683
Approves		Date	26/02/2021

RHYTHM_EK_D_PLINT_1050-1050X9X100

Colour

20.27=ML ML MD519 (EVELYN)

Edge

01.240=1MM MD519

R&D REVIEW	
<input type="checkbox"/>	DWG.Customer
<input type="checkbox"/>	Work Report
<input type="checkbox"/>	Function
<input type="checkbox"/>	สินค้าตรงตัวอย่าง
ผู้ทบทวน _____	

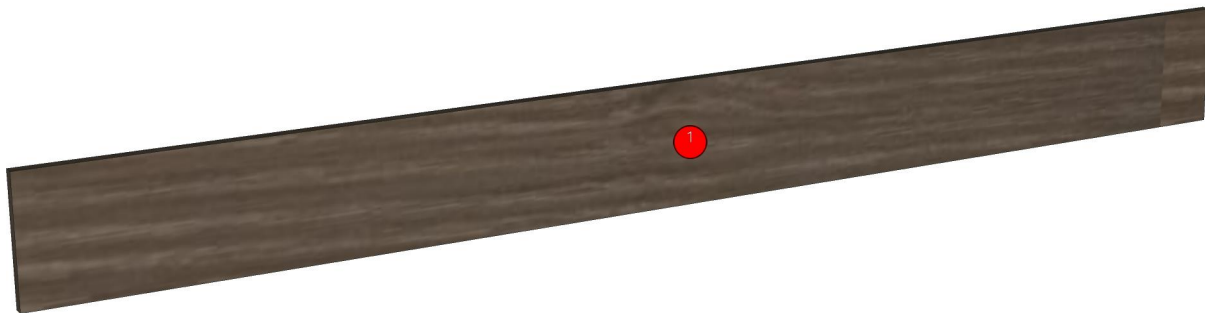

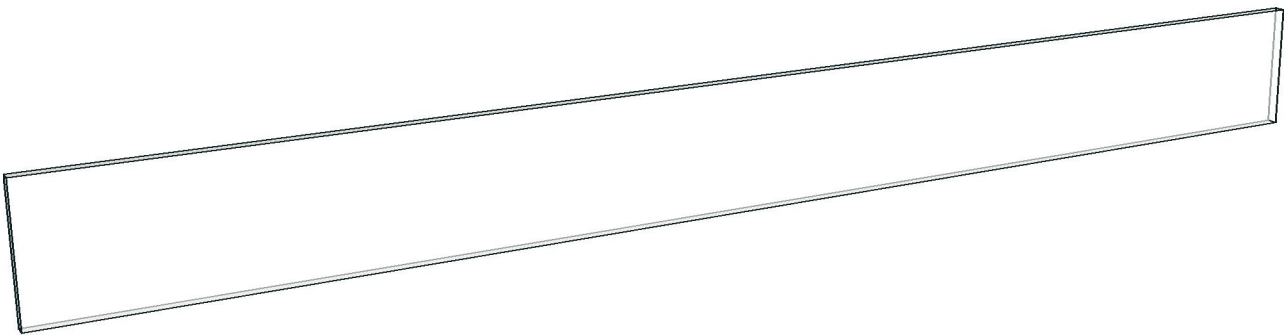
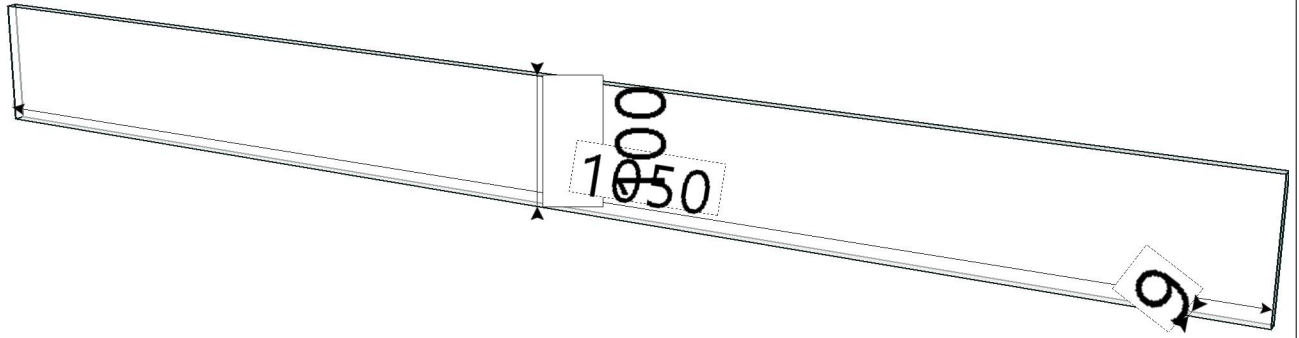

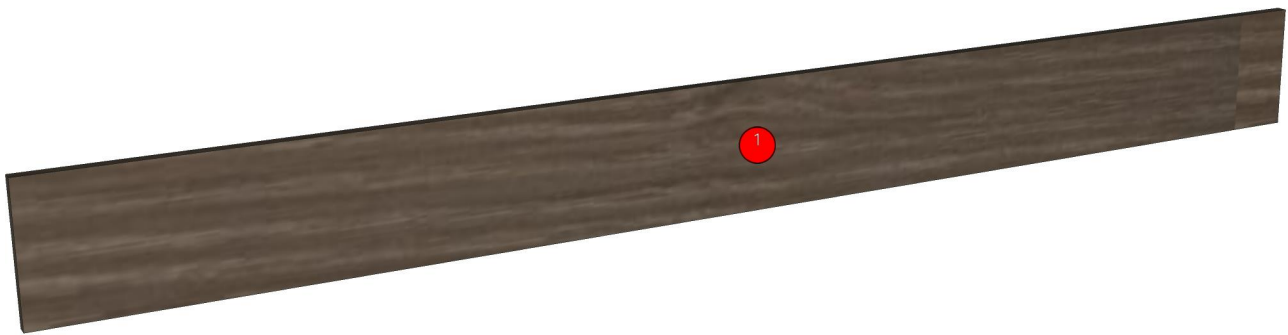
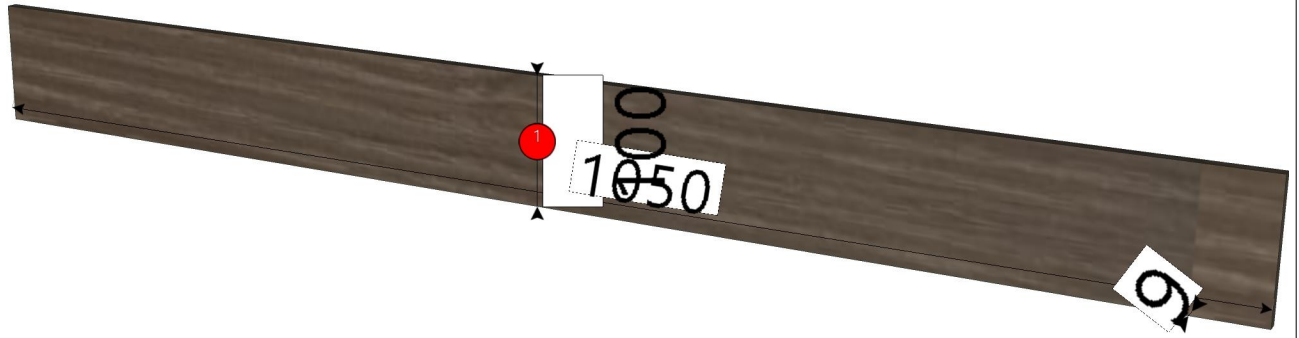

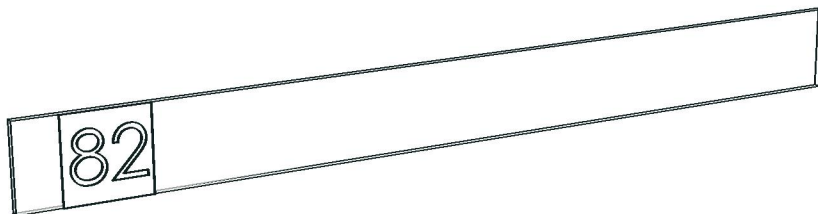
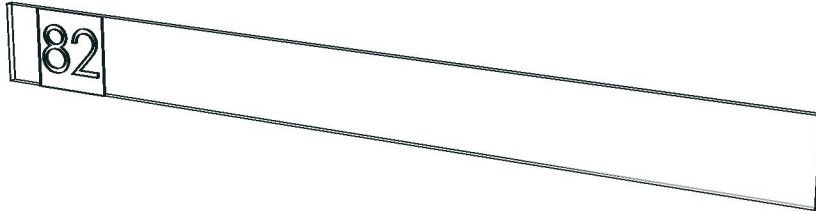

Model	RHYTHM_EK_D_PLINT_1050		
Creator	YUTHAPONG	.BCP Name	INDEX_C3D_KITCHEN2
Reviewer		Order	F000683
Approves		Date	26/02/2021

No.	Article No.	Description	Mat	Dimension	Cutting Size	Typepology	Skin
0	RHYTHM_EK_D_PLINT_1050			1050x100x9			
	RHYTHM_EK_D_PLINT_1050-0-82	PLINT	PB-SP	9x100x1050	9X99X1049;L1:W1	582000 _STR=20.27 _EDG=MD519-1	2

