

<b>Model</b>	LIFE_SR_DF(CL_03)1800		
<b>Creator</b>	YUTHAPONG	<b>.BCP Name</b>	INDEX_C3D_KITCHEN2
<b>Reviewer</b>		<b>Order</b>	F000575
<b>Approves</b>		<b>Date</b>	18/02/2021

## **LIFE\_SR\_DF(CL\_03)1800-1800X200X375**

**Colour**  
20.16=ML BM1 (CONCRETE)

**Edge**  
01.253=1MM MB1

<b>R&amp;D REVIEW</b>	
<input type="checkbox"/>	DWG.Customer
<input type="checkbox"/>	Work Report
<input type="checkbox"/>	Function
<input type="checkbox"/>	สินค้าตรงตัวอย่าง
ผู้ทบทวน _____	
_____	

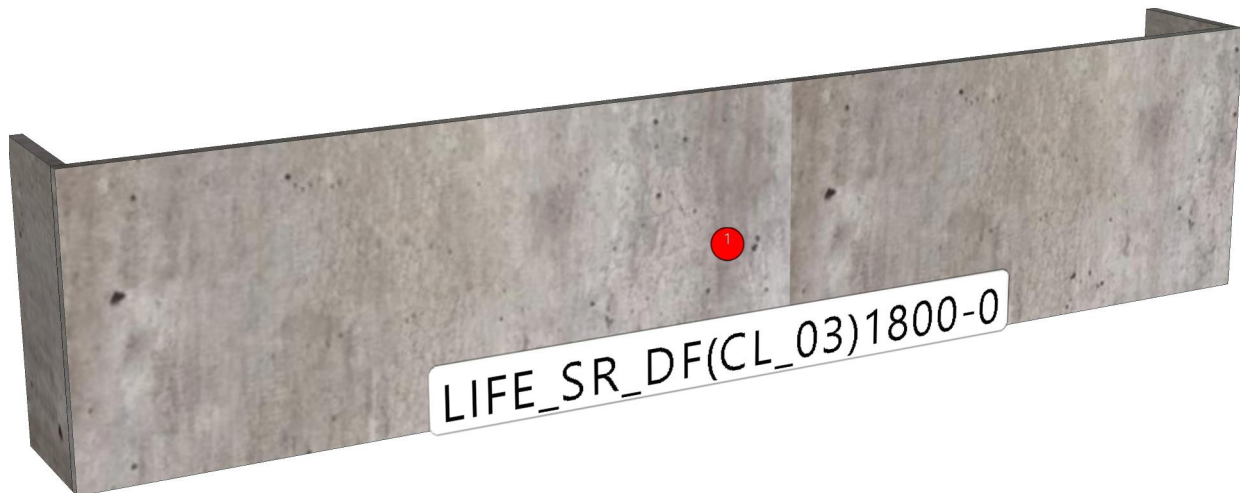

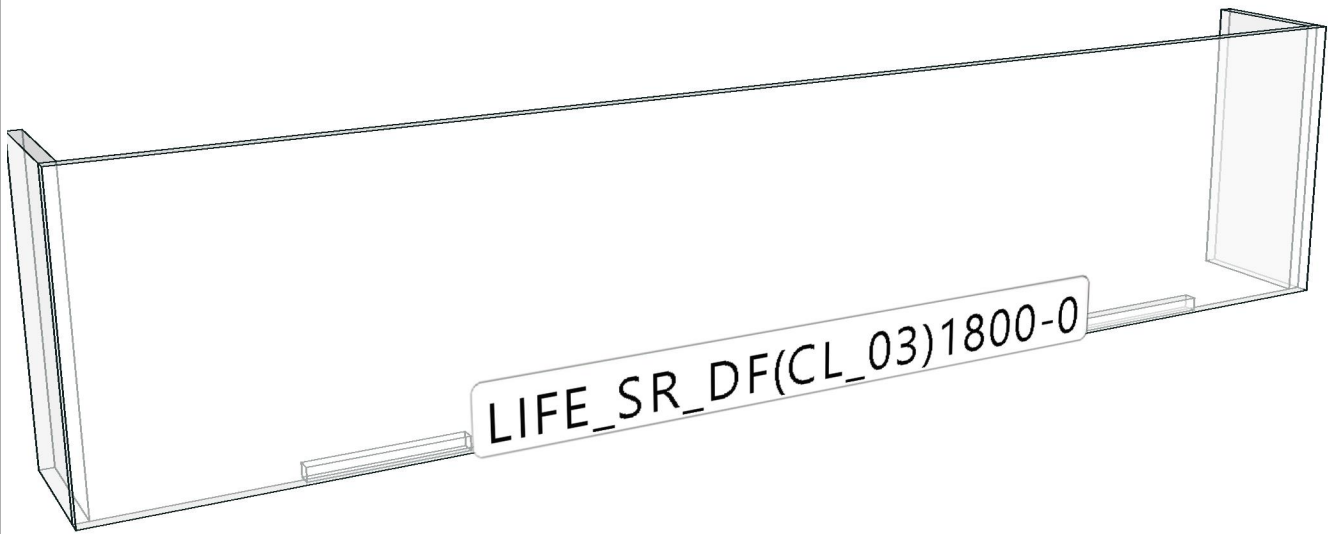
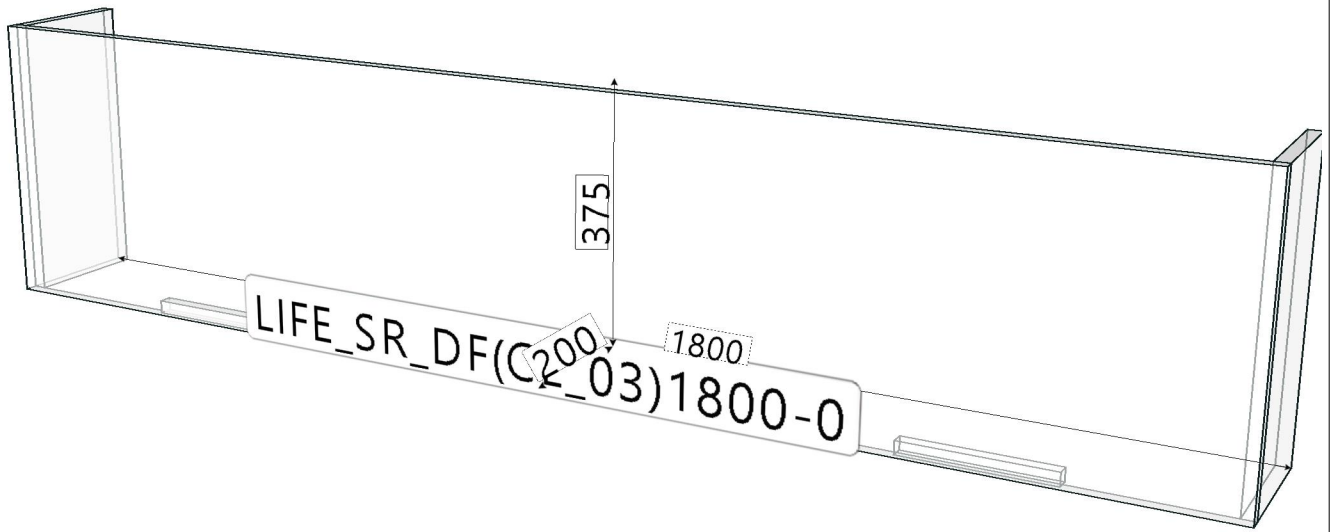

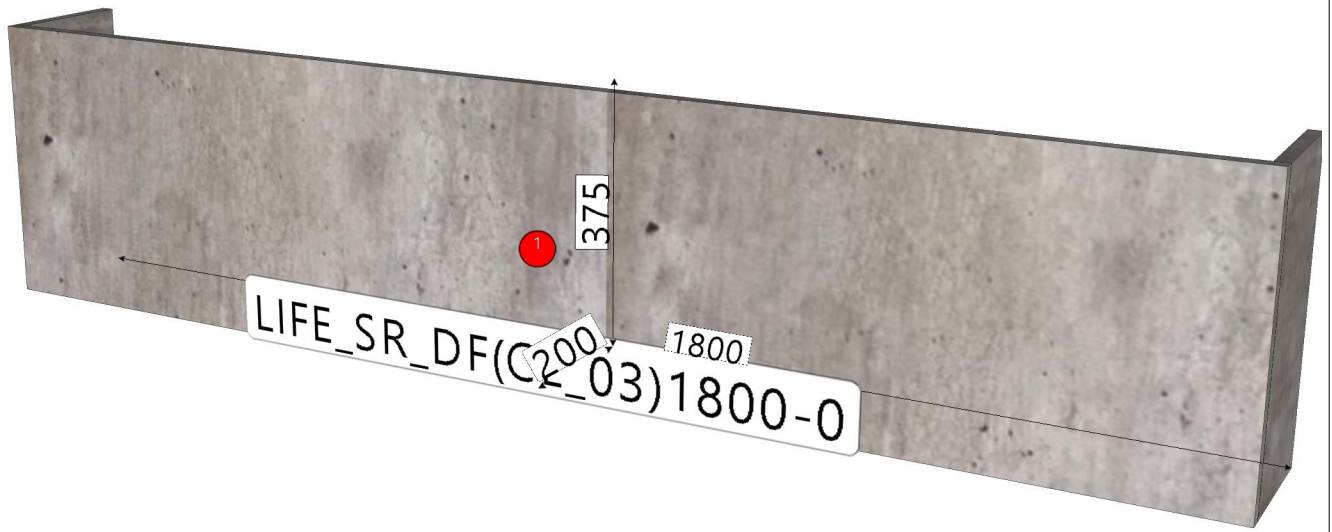

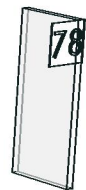
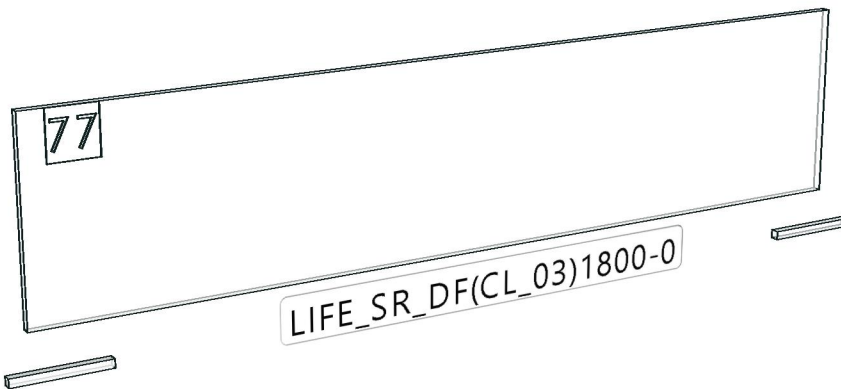
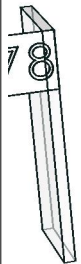
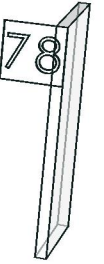
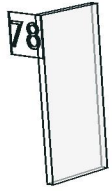

<b>Model</b>	LIFE_SR_DF(CL_03)1800		
<b>Creator</b>	YUTHAPONG	<b>.BCP Name</b>	INDEX_C3D_KITCHEN2
<b>Reviewer</b>		<b>Order</b>	F000575
<b>Approves</b>		<b>Date</b>	18/02/2021

No.	Article No.	Description	Mat	Dimension	Cutting Size	Typepology	Skin
0	LIFE_SR_DF(CL_03)1800			1800x375x200			
	LIFE_SR_DF(CL_03)1800-0-77	FRONT CELLING	PB-ST	18x400x1800	18X399X1798;L1:W2	577000_STR=20.16_EDG=BM1-1	2
	LIFE_SR_DF(CL_03)1800-0-78	LEFT - RIGHT CELLING	PB-ST	18x182x400	18X180X398;L2:W2	578000_STR=20.16_EDG=BM1-1	2
	LIFE_SR_DF(CL_03)1800-0-78	LEFT - RIGHT CELLING	PB-ST	18x182x400	18X180X398;L2:W2	578001_STR=20.16_EDG=BM1-1	2

# FITTING LIST

Qty per 1 set

No	New	Article fitting	List	Connect	Qty/Pcs				Cost / Qty	Sum Cost
					Spray	Ass	Pack	Sum		
0		LIFE_SR_DF(CL_03)	1800	1800x375x200						
		3220300006	ไม้ก่อน MDF18x18x200 mm. ปิดผิว Dead Stock 2 หน้า				5	5		
		4130100147	สกรู C/B เกลียวตลอด P+M4x30 ชิงค์ขาว #0747				20	20		

No	Date	REVISION RECORD	REMARK	Create	YUTHAPONG	date:18/02/2021	Product name : -
4				Revivewer		date:	Article: TYPE:
3				Approves		date:	
2				Design			Customer: Indexlivingmall
1	18/02/2021	First departure		Name&Art			No:
<b>INTERFURN</b> INDEX INTERFURN CO.LTD Document control FR-RD-004 : REV#00:24/04/60							Page 3