

Model	RHYTHM_EK_DBS95(GL)		
Creator	YUTHAPONG	.BCP Name	INDEX_C3D_KITCHEN2
Reviewer		Order	F000637
Approves		Date	26/02/2021

RHYTHM_EK_DBS95(GL)-950X570X860

Colour

20.27=ML ML MD519 (EVELYN)

20.07=ML AE9V (MATT)

Edge

01.240=1MM MD519

01.47=1MM WHITE

R&D REVIEW	
<input type="checkbox"/>	DWG.Customer
<input type="checkbox"/>	Work Report
<input type="checkbox"/>	Function
<input type="checkbox"/>	สินค้าตรงตัวอย่าง
ผู้ทบทวน _____	

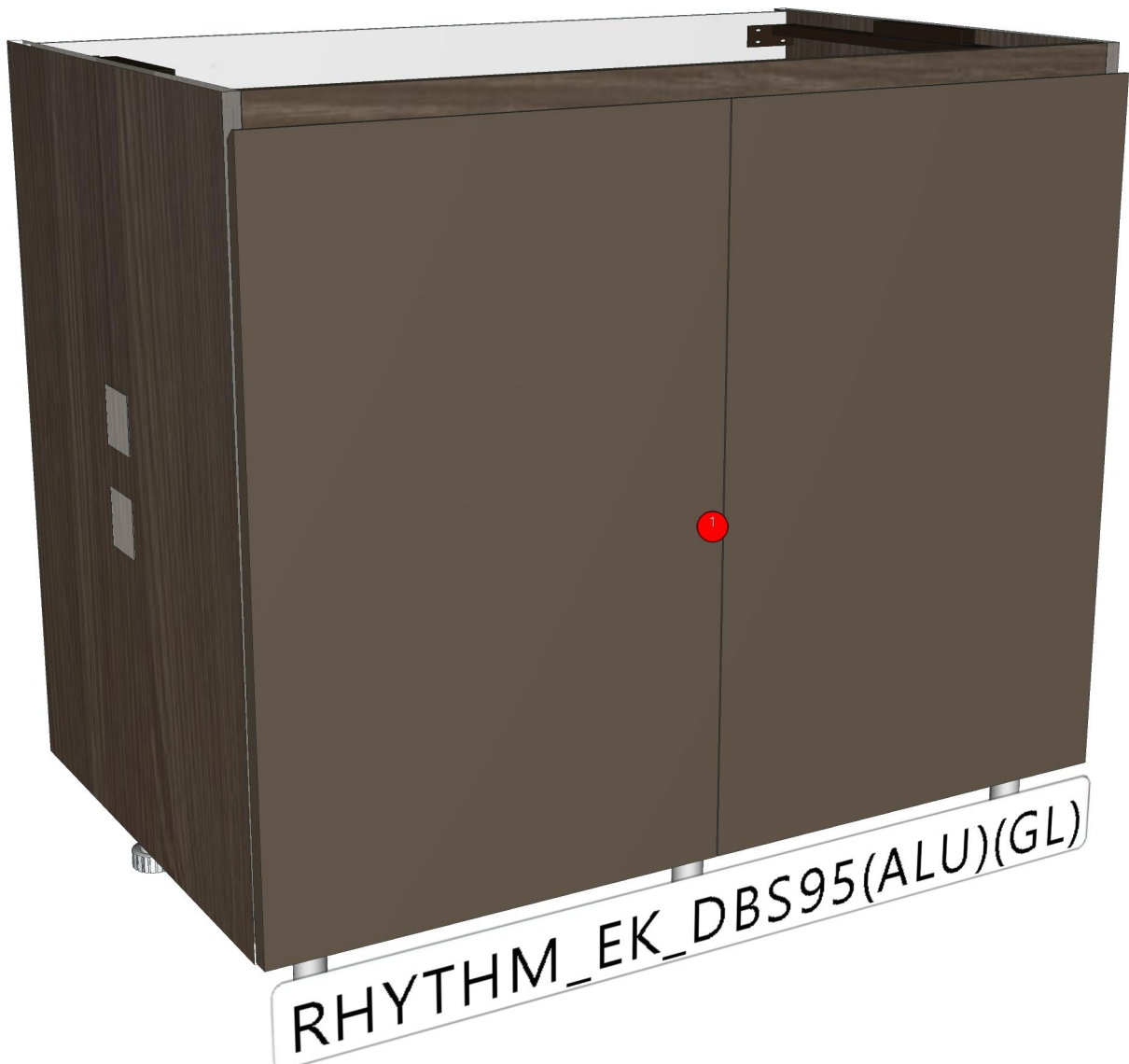

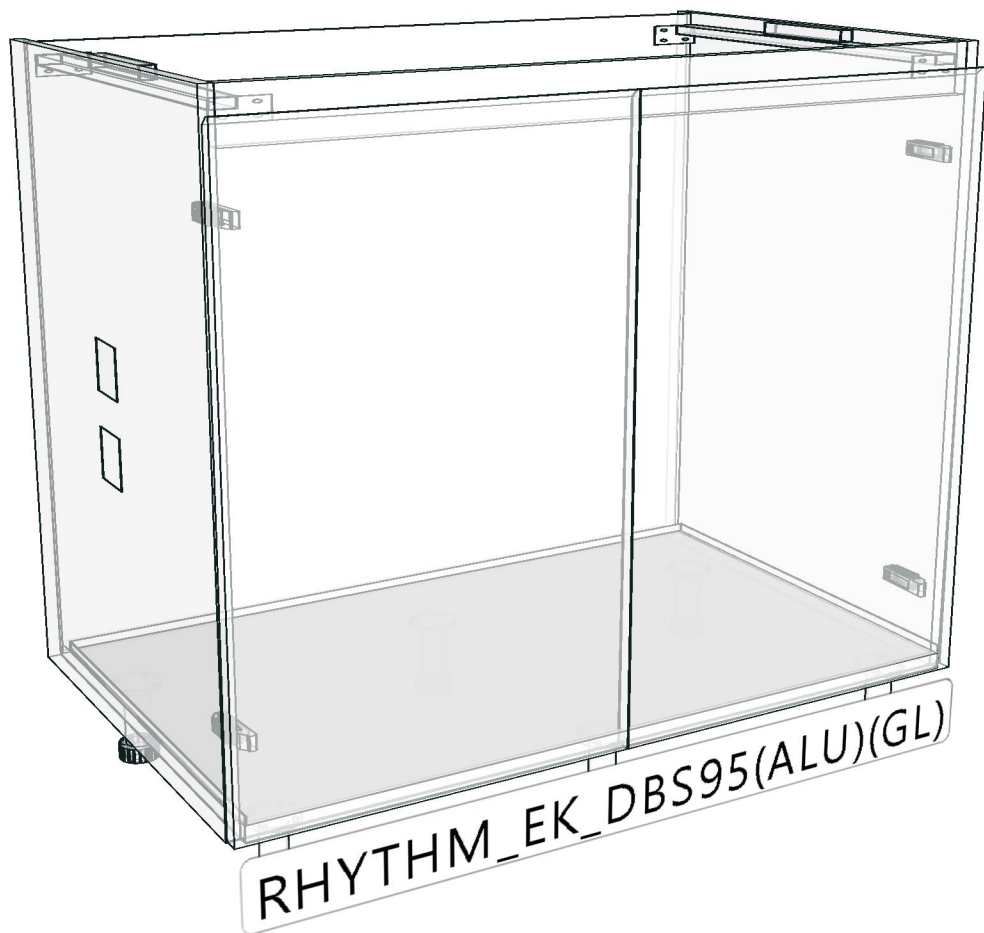
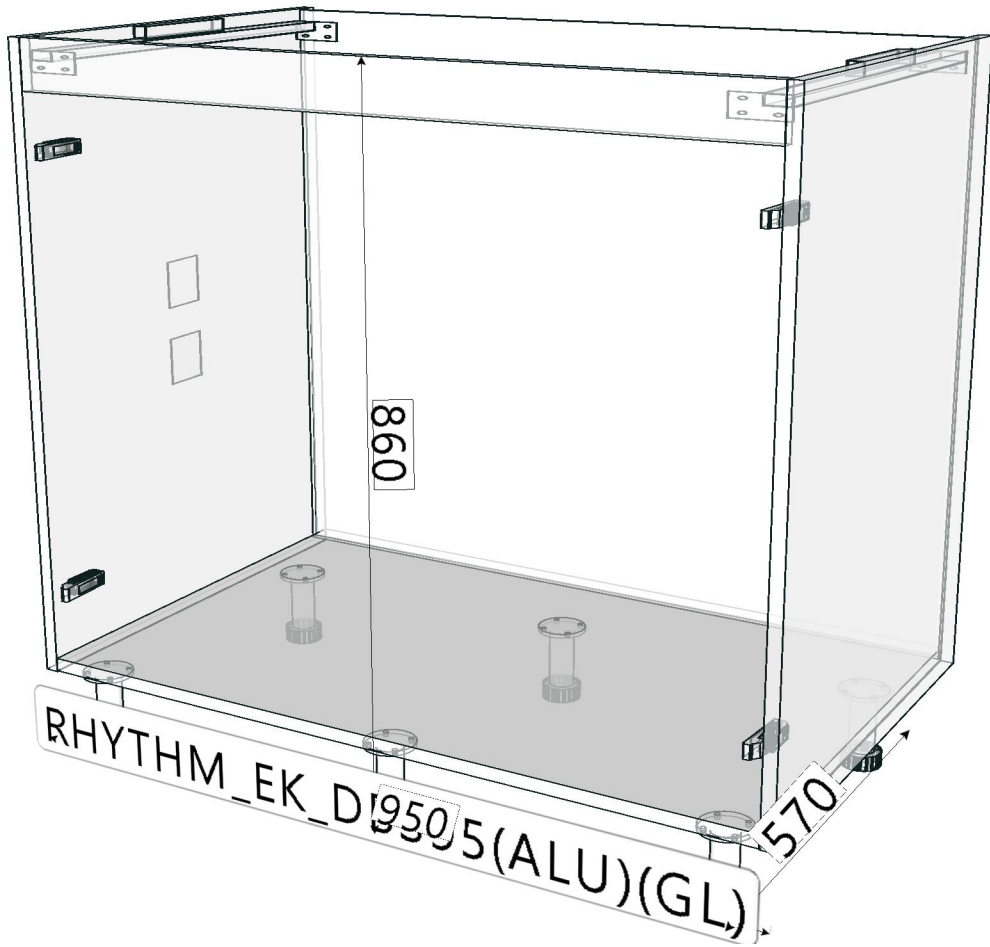

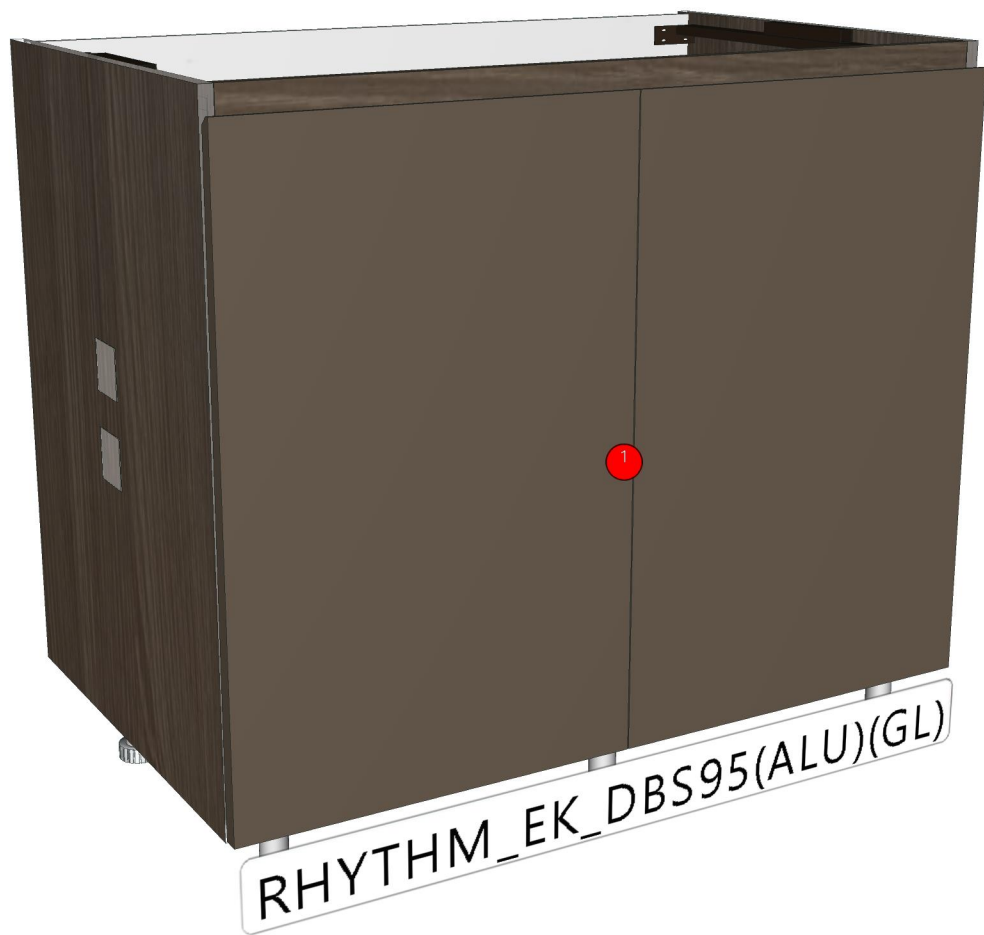
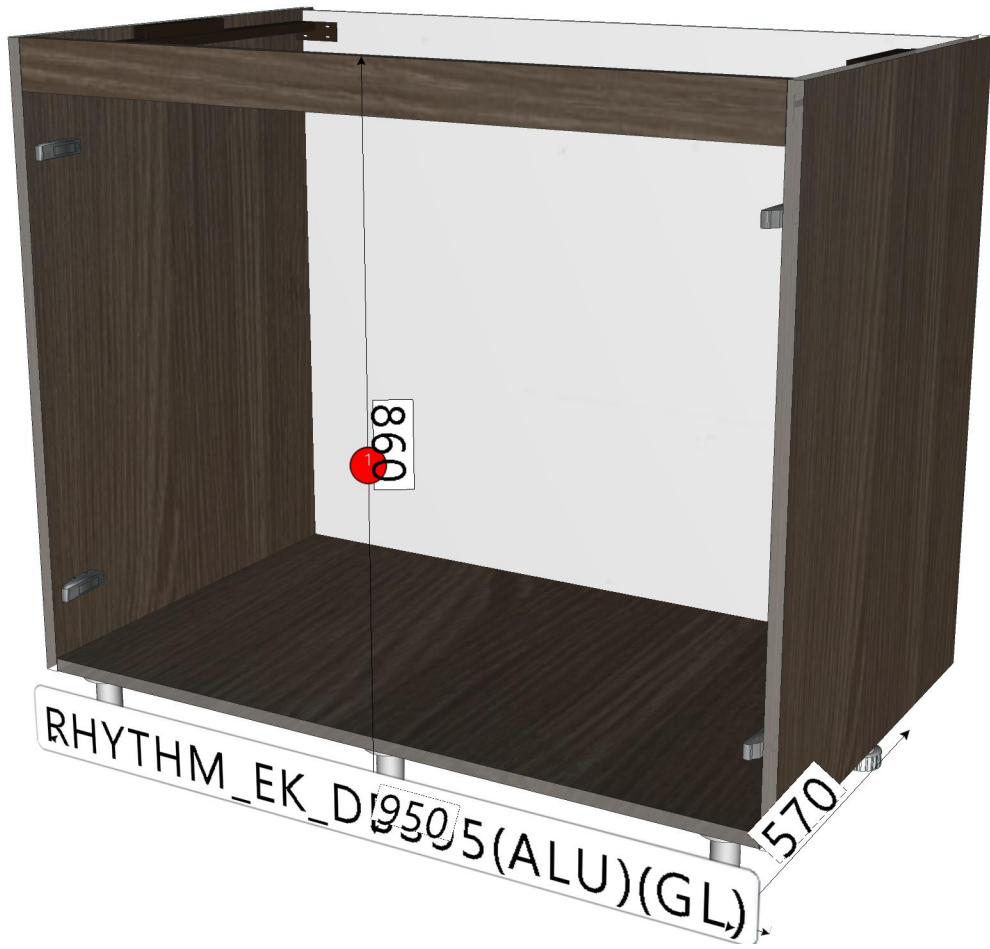

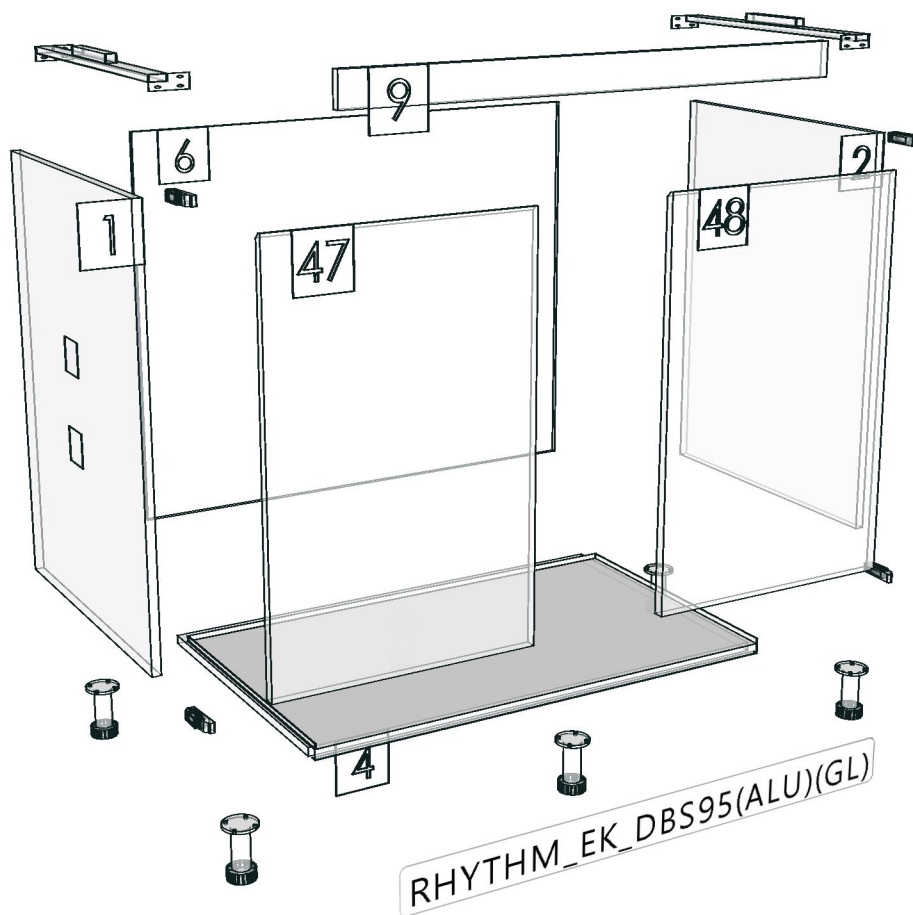
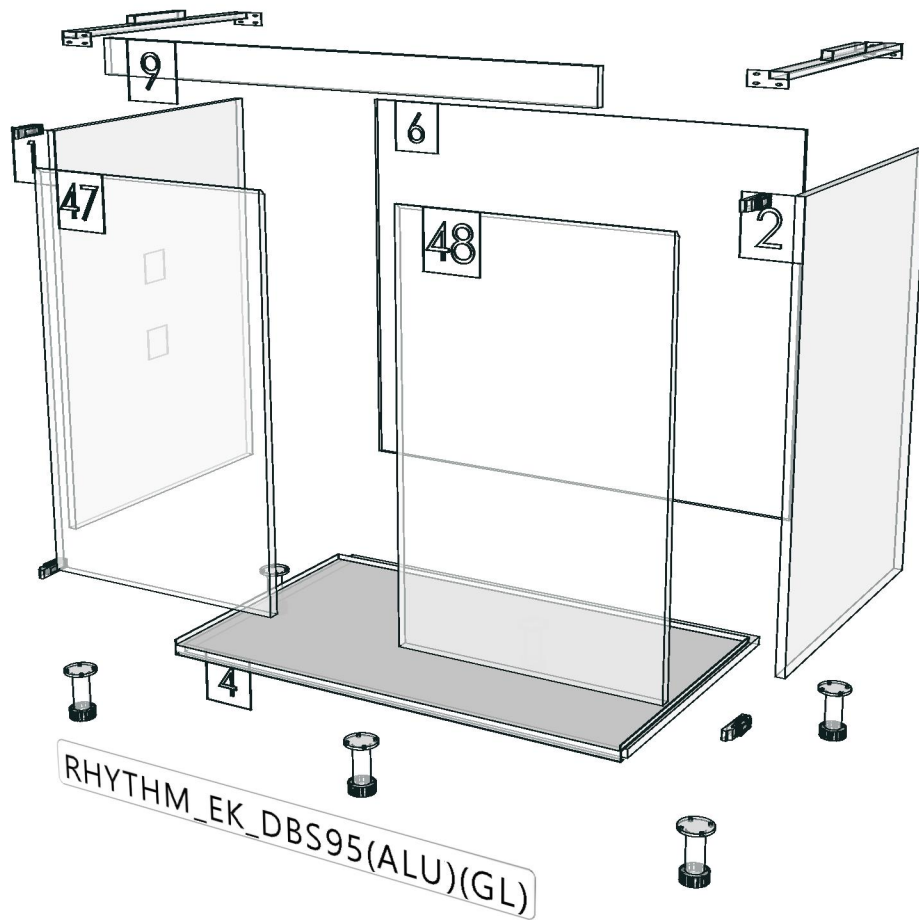

Model	RHYTHM_EK_DBS95(GL)		
Creator	YUTHAPONG	.BCP Name	INDEX_C3D_KITCHEN2
Reviewer		Order	F000637
Approves		Date	26/02/2021

No.	Article No.	Description	Mat	Dimension	Cutting Size	Typepology	Skin
0	RHYTHM_EK_DBS95(GL)			950x860x570			
	RHYTHM_EK_DBS95(ALU)(GL)-0-01	LEFT PANEL	PB-SP	16x570x760	16X568X758;L2:W2	501000 _STR=20.27 _EDG=MD519-1	2
	RHYTHM_EK_DBS95(ALU)(GL)-0-02	RIGHT PANEL	PB-SP	16x570x760	16X568X758;L2:W2	502000 _STR=20.27 _EDG=MD519-1	2
	RHYTHM_EK_DBS95(ALU)(GL)-0-04	BOTTOM PANEL	PB-SP	16x570x917	16X568X917;L2:W0	504000 _STR=20.27 _EDG=MD519-1	2
	RHYTHM_EK_DBS95(ALU)(GL)-0-06	REAR PANEL HOL	PB-SP	9x927x746.5	9X927X746.5;NO EDGE	506000 _STR=20.07 _EDG=-	2
	RHYTHM_EK_DBS95(ALU)(GL)-0-09	BEAM FRONT VER	PB-SP	16x60x917	16X58X917;L2:W0	509000 _STR=20.27 _EDG=MD519-1	2
	RHYTHM_EK_DBS95(GL)-0-47	DOOR ALP BASE 1*SF(W1)	PB-ST	19x472x730	19X470X728;L2:W2	547000 _STR=20.27 _EDG=MD519-1	2
	RHYTHM_EK_DBS95(GL)-0-48	DOOR ALP BASE 2*SF(W1)	PB-ST	19x472x730	19X470X728;L2:W2	548000 _STR=20.27 _EDG=MD519-1	2

FITTING LIST						Qty per 1 set				
No	New	Article fitting	List	Connect	Qty/Pcs				Cost / Qty	Sum Cost
					Spray	Ass	Pack	Sum		
0		RHYTHM_EK_DBS95(GL)		950x860x570						
		3060796211	เหล็กคานรับ SINK ข้างซ้าย ขนาด 40x65x528 mm. ฟันสีดำ # S18002FN				1	1		
		3060796511	เหล็กคานรับ SINK ข้างขวา ขนาด 40x65x528 mm. ฟันสีดำ # S18002FN				1	1		
		4120200092	ปุ่มยางกันกระแทก สีใส				4	4		
		4120300314	บานพับทับขอบ+ปีกผีเสื้อ Fixed Soft Close hinge #				4	4		
		4120800526	ฝาครอบท่อ 2" วัสดุ ABS สีขาวผิวเม็ดทราย #721				2	2		
		4120900254	ฝาปิดหัวสกรู(เดือยแฉก) สีน้ำตาลเข้ม #00905 (Walnu				4	4		
		4121000262	ยางรองกันน้ำสีใส (5เมตร/เส้น) (05-37-0400-0001)1				2	2		
		4121500040	พลาสติกร้อยสายไฟอันใหญ่ 60 mm.สีน้ำตาล				4	4		
		4121800024	ฝาครอบท่อ 3/4" สีขาวผิวเม็ดทราย(ABS) #721(175-005-017)				2	2		
		4121800154	คลิปล็อคพลาสติกสีดำ CS0624 ใช้กับขาไม้(SUP.แถมฟรี)				6	6		
		4121800156	ขาปรับระดับตู้ สูง 100 มม. CS-06202-10 ใช้ขาไม้+ขาอลู				6	6		
		4130100064	สกรูเกลียวปหล่อ F+6x3/8" นิเกิล #0912				6	6		
		4130100064	สกรูเกลียวปหล่อ F+6x3/8" นิเกิล #0912				4	4		
		4130100117	สกรู C/B เกลียวตลอด F+M4x13 ชิงค์ขาว #0747				12	12		
		4130100118	สกรู C/B เกลียวตลอด F+M4x16 ชิงค์ขาว #0747				38	38		
		4130100118	สกรู C/B เกลียวตลอด F+M4x16 ชิงค์ขาว #0747				28	28		
		4130100120	สกรู C/B เกลียวตลอด F+M4x25 ชิงค์ขาว #0747				4	4		
		4130800004	Bolts steel yellow galv 262.27.615 24/5 mm.HAFELE				6	6		
		4130800012	Casing Minifix 16 mm.nickle plated 262.26.533 HAFELE				6	6		
		4131000017	เดือยไม้พารา 0 8x35mm.ไม้ทำสี				8	8		
		999NOCODE	ALUMINIUM UNDER SINK CUT SIZE 917 X 542				1	1		

No	Date	REVISION RECORD	REMARK	Create	YUTHAPONG	date:26/02/2021	Product name : -
4				Revivewer		date:	Article: TYPE:
3				Approves		date:	
2				Design			Customer: Indexlivingmall
1	26/02/2021	First departure		Name&Art			No:
INTERFURN INDEX INTERFURN CO.LTD Document control FR-RD-004 : REV#00:24/04/60							Page 3