

# CHAMP M01

Show cabinet/w dr-L

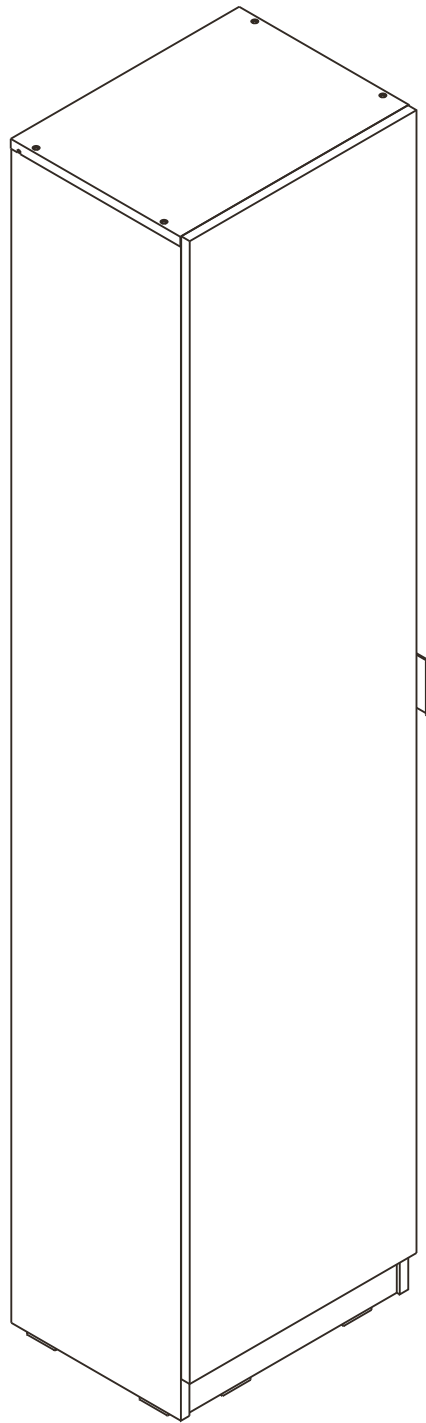

# CONNECT SYSTEM

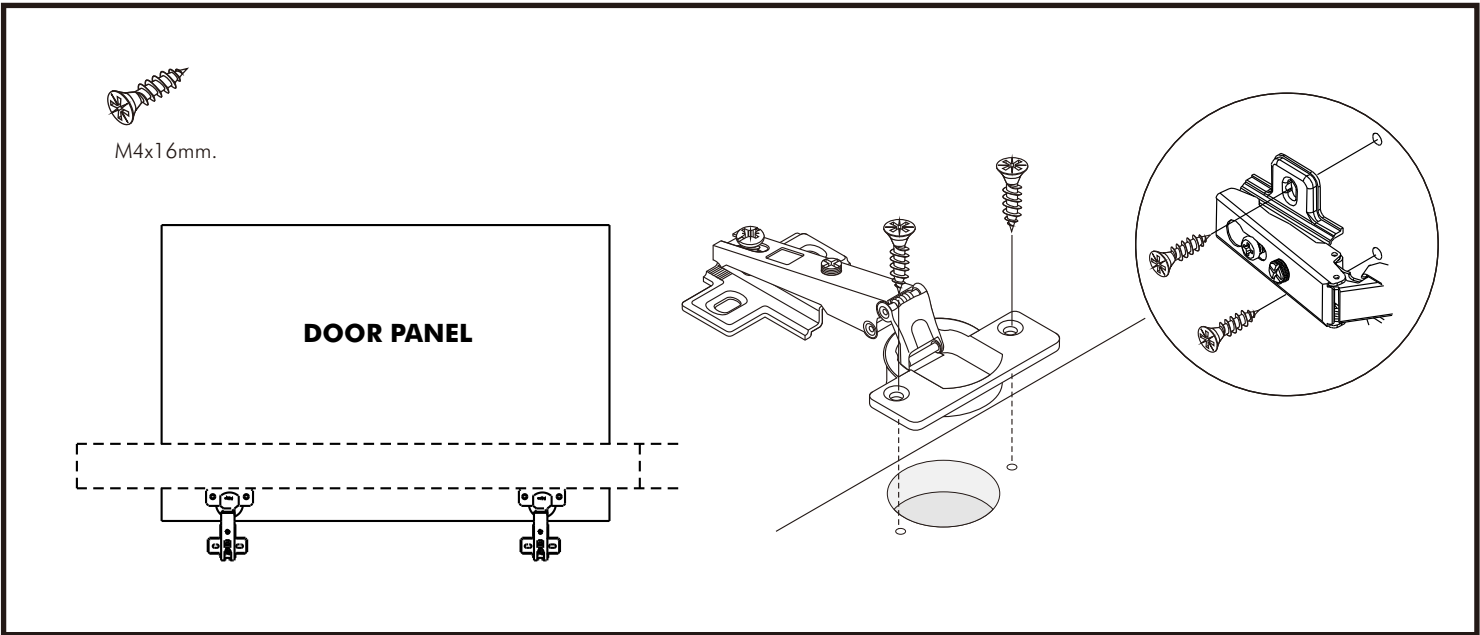
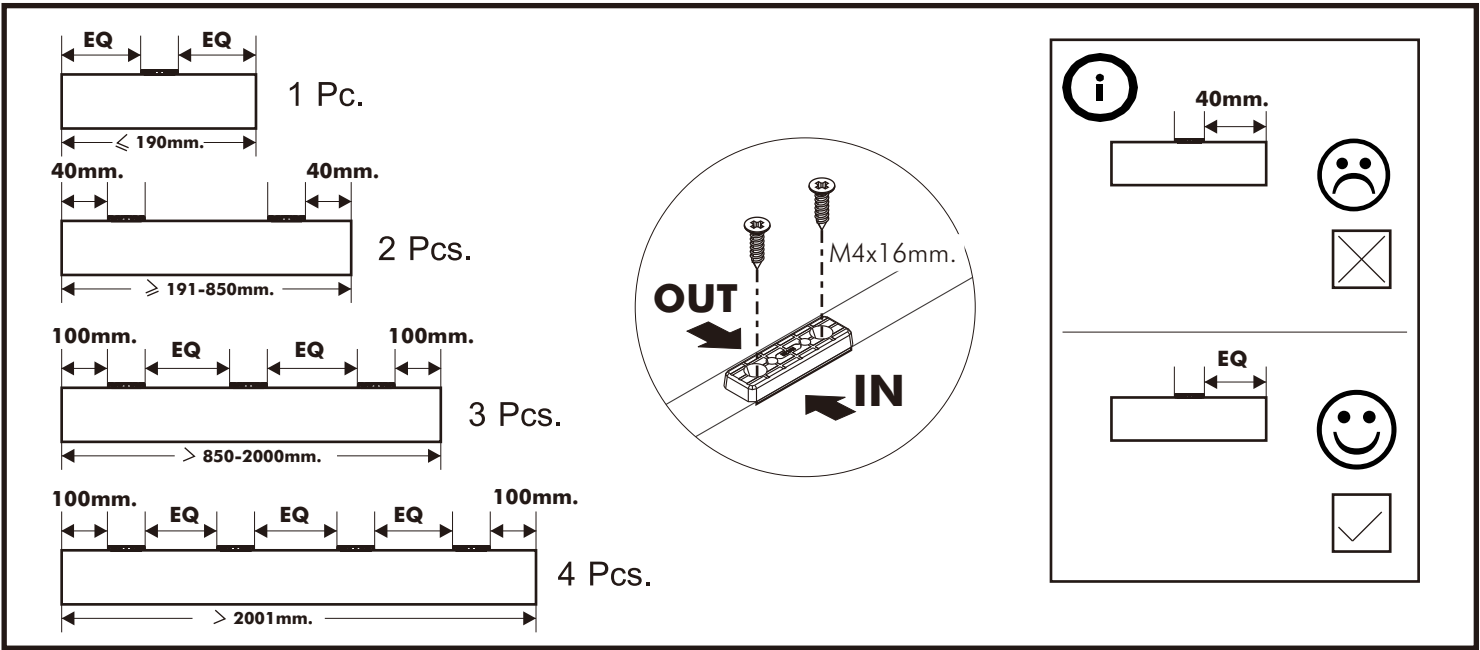
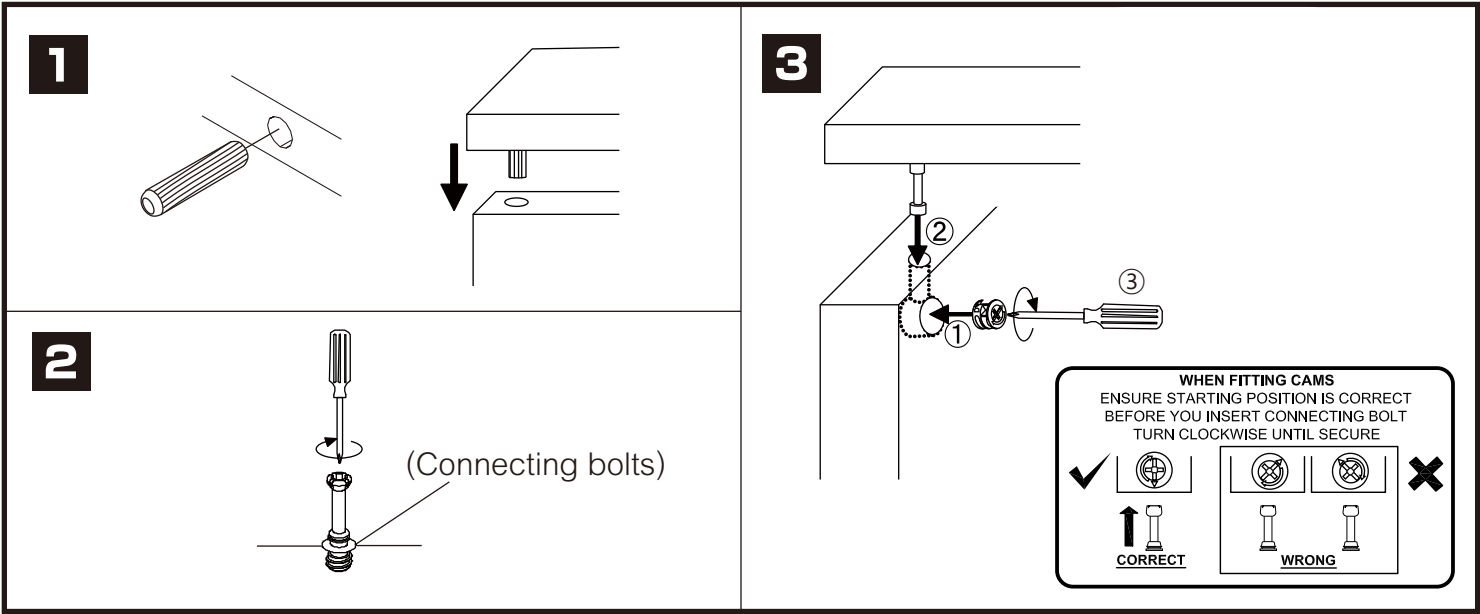

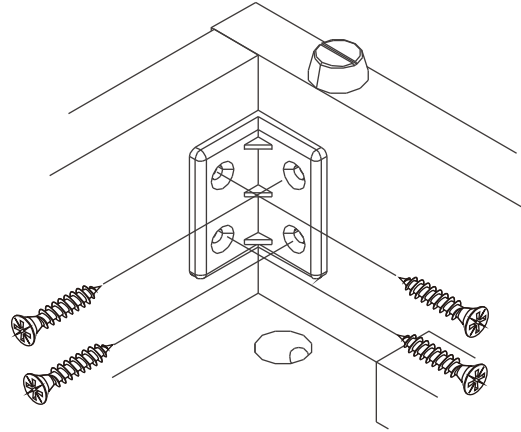
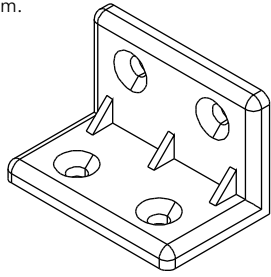
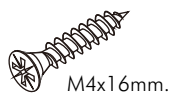

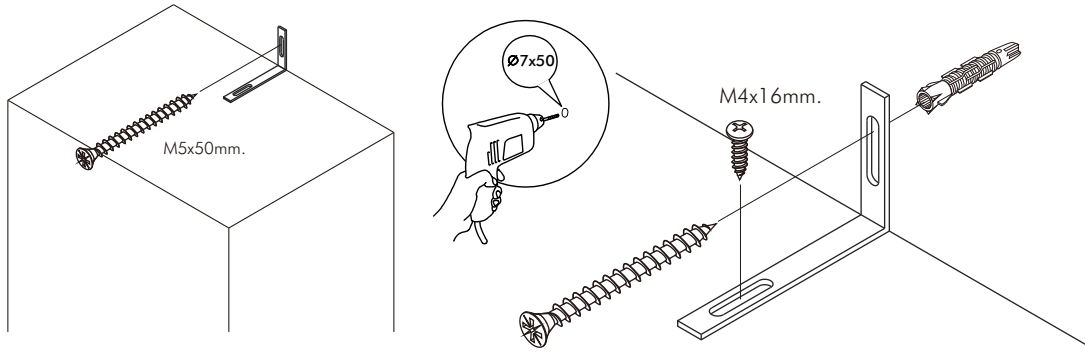

## มาตรฐาน การระบุสินค้าที่ต้องยึด Fitting กันสั่น (Safety Fitting) \*\*\*หมายเหตุ เป็นชุดเด็ก ไม้ชุดตั้ง Fitting กันสั่นทุกตัว\*\*\*

■ หมวด ตู้บานเปิด / ตู้บานปิด + ช่องใส่

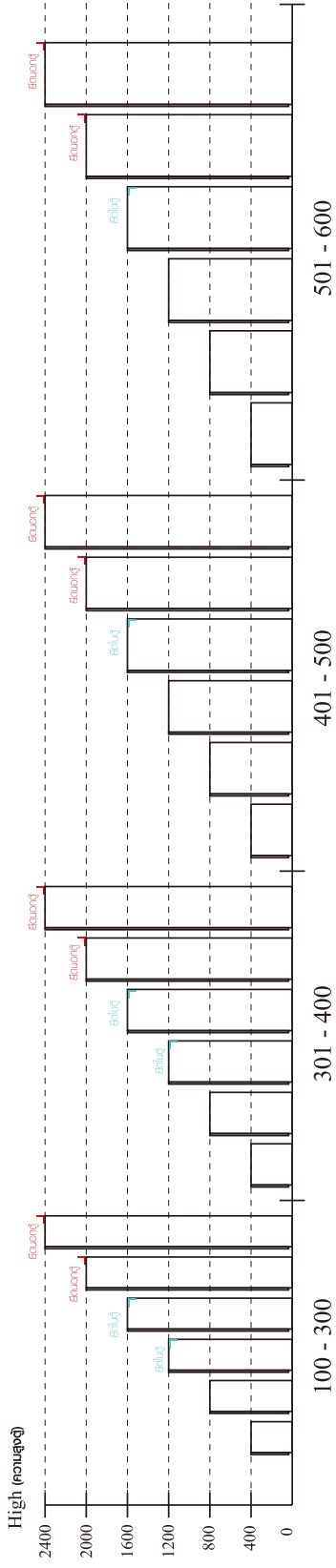

■ ติดตั้งจากกันสั่นกับตู้สูง (ตั้งแต่ 2 m. ขึ้นไป)



■ หมวด ตู้ลิ้นชัก / ตู้ลิ้นชัก + ช่องใส่ / ตู้ลิ้นชัก + บานเปิด / ตู้ลิ้นชัก + บานสไลด์



■ ติดตั้งจากกันสั่นกับตู้เตี้ย (น้อยกว่า 2 m.)

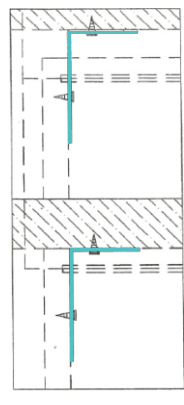

■ หมวด ตู้บานสไลด์ / ตู้ใส่

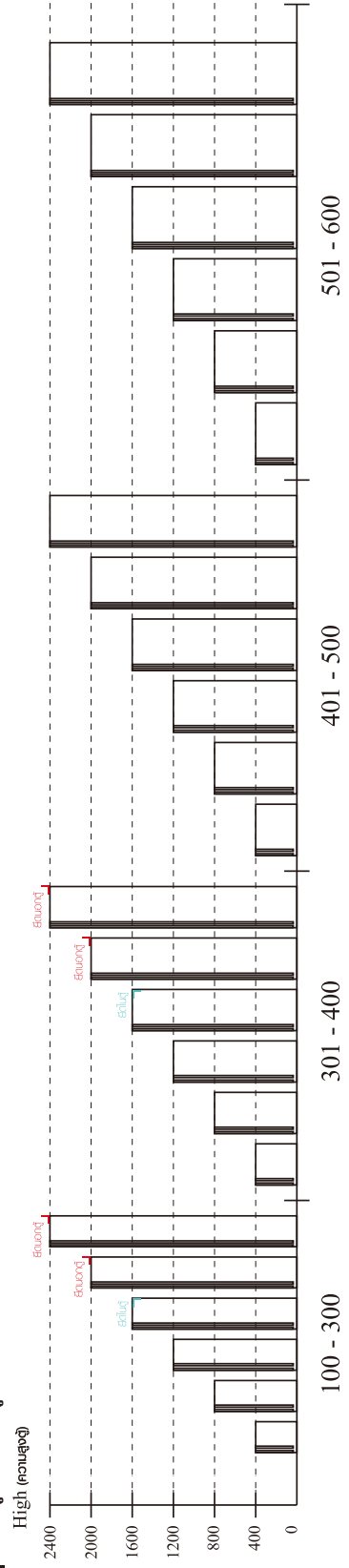

# HARDWARE

## -BODY SET

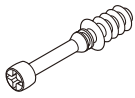

**x 4**



**x 4**

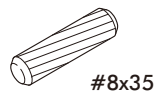

**x 8**

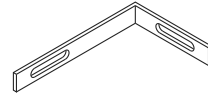

**x 1**

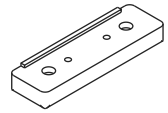

**x 8**

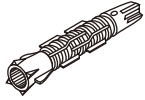

**x 1**

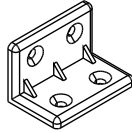

**x 10**



**x 56**

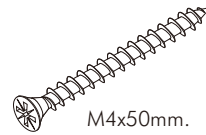

**x 4**

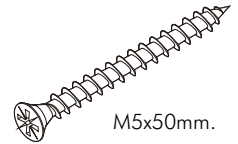

**x 1**



**x 3**



**x 8**

## -DOOR SET

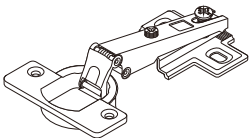

**x 4**



**x 16**

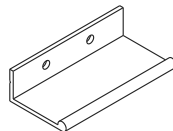

**x 1**



**x 2**



**x 2**

# ASSEMBLY

-BODY SET

**1.**

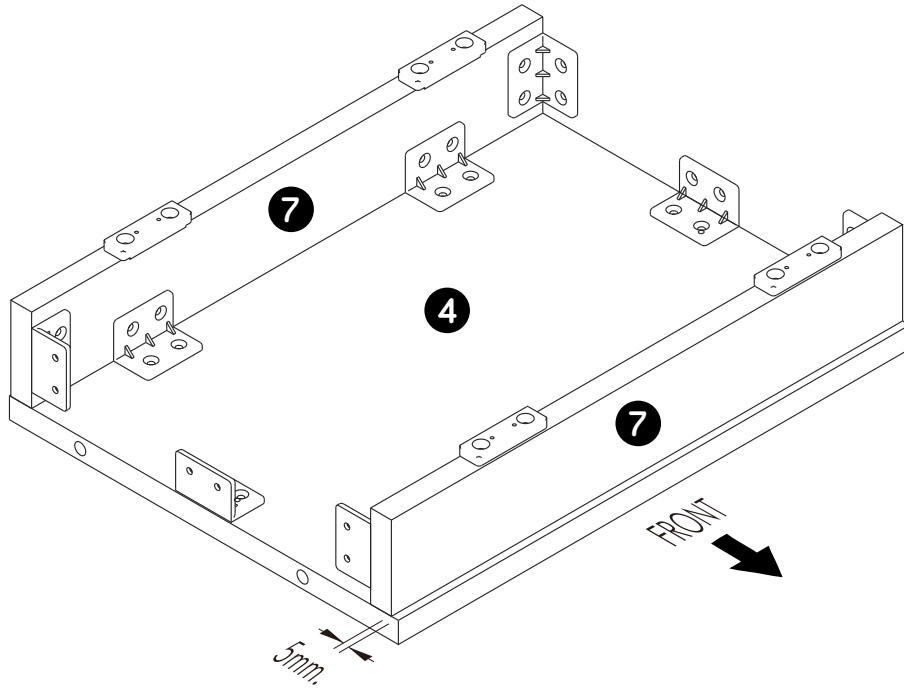

**2.**

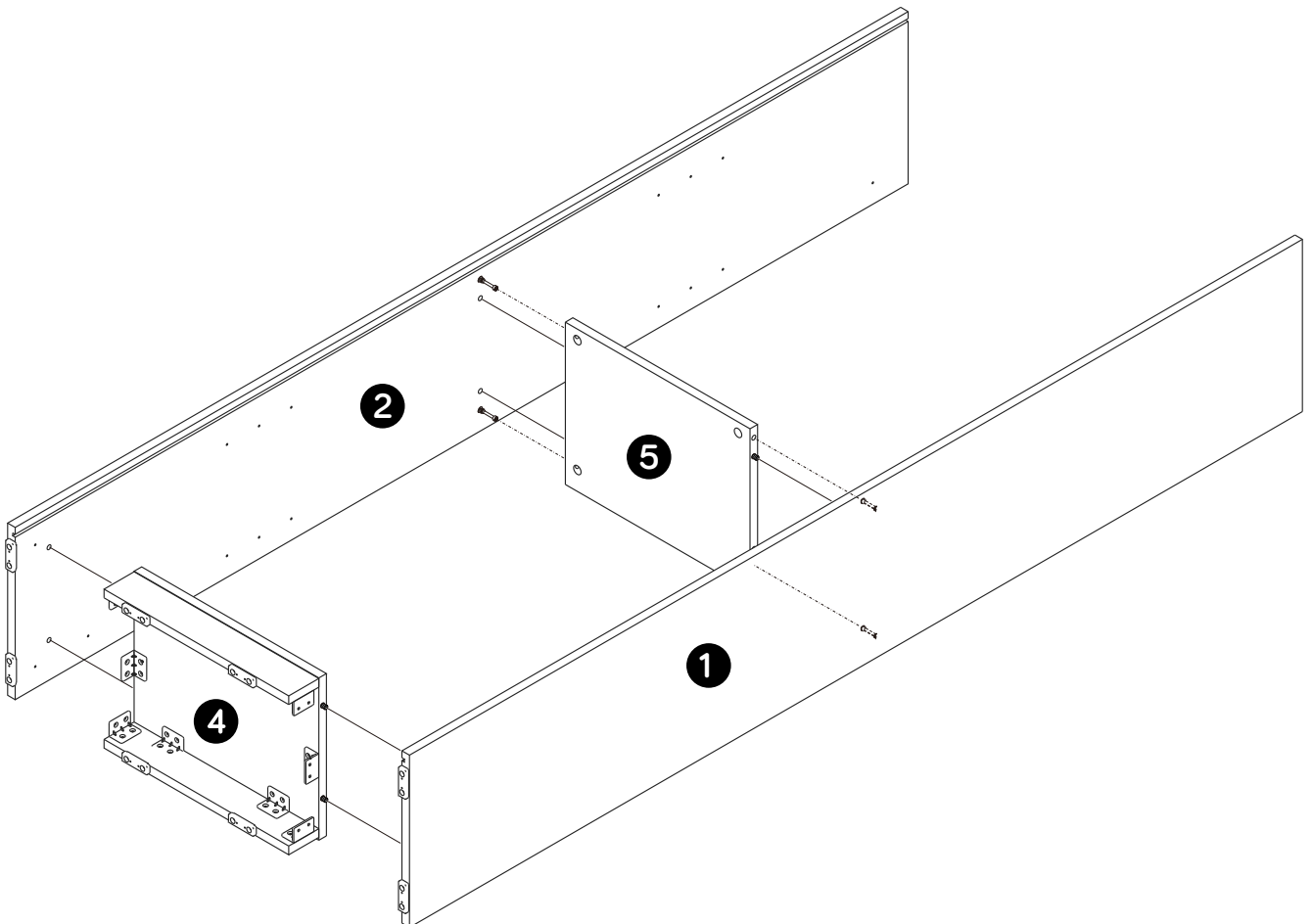

**3.**

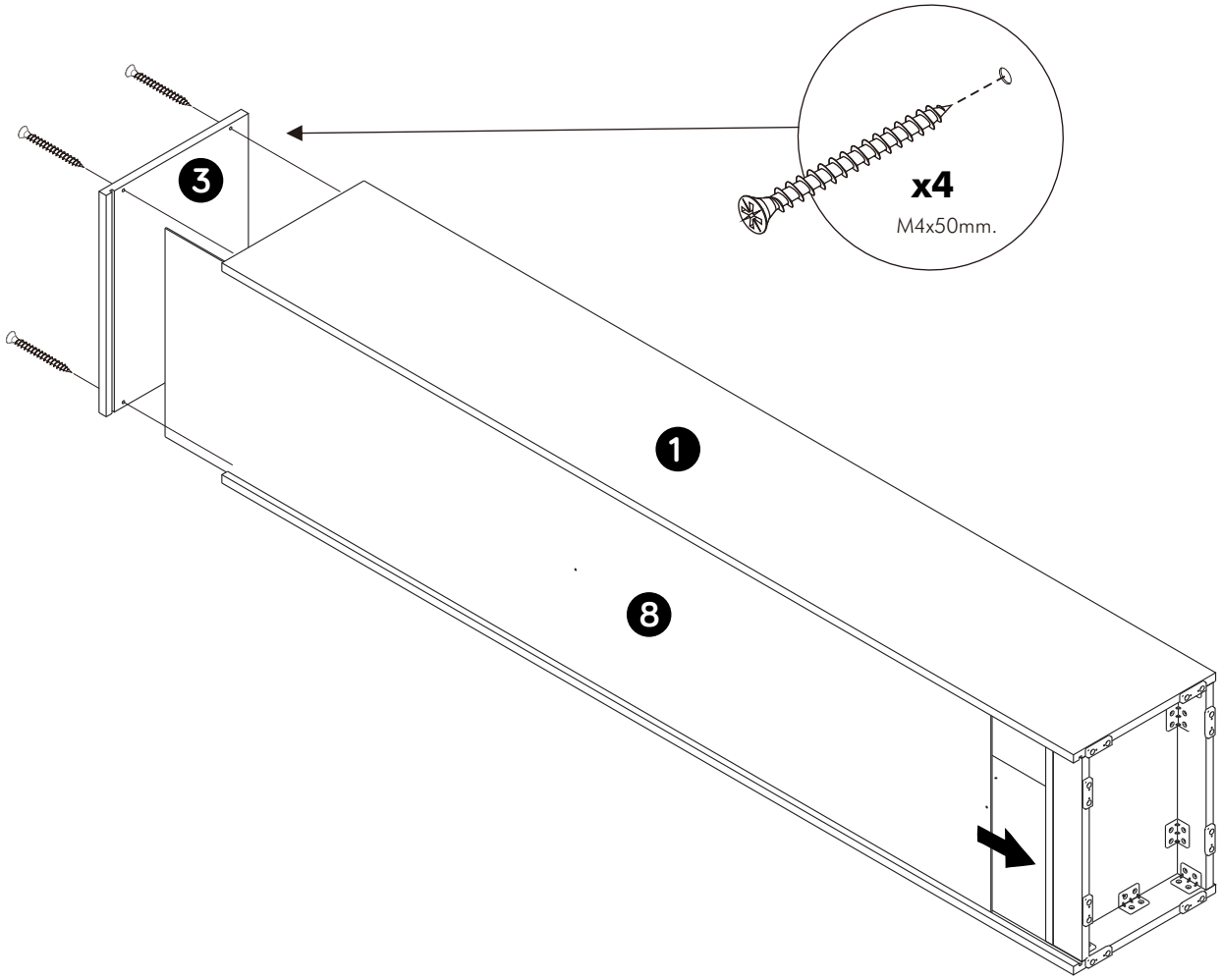

**4.**

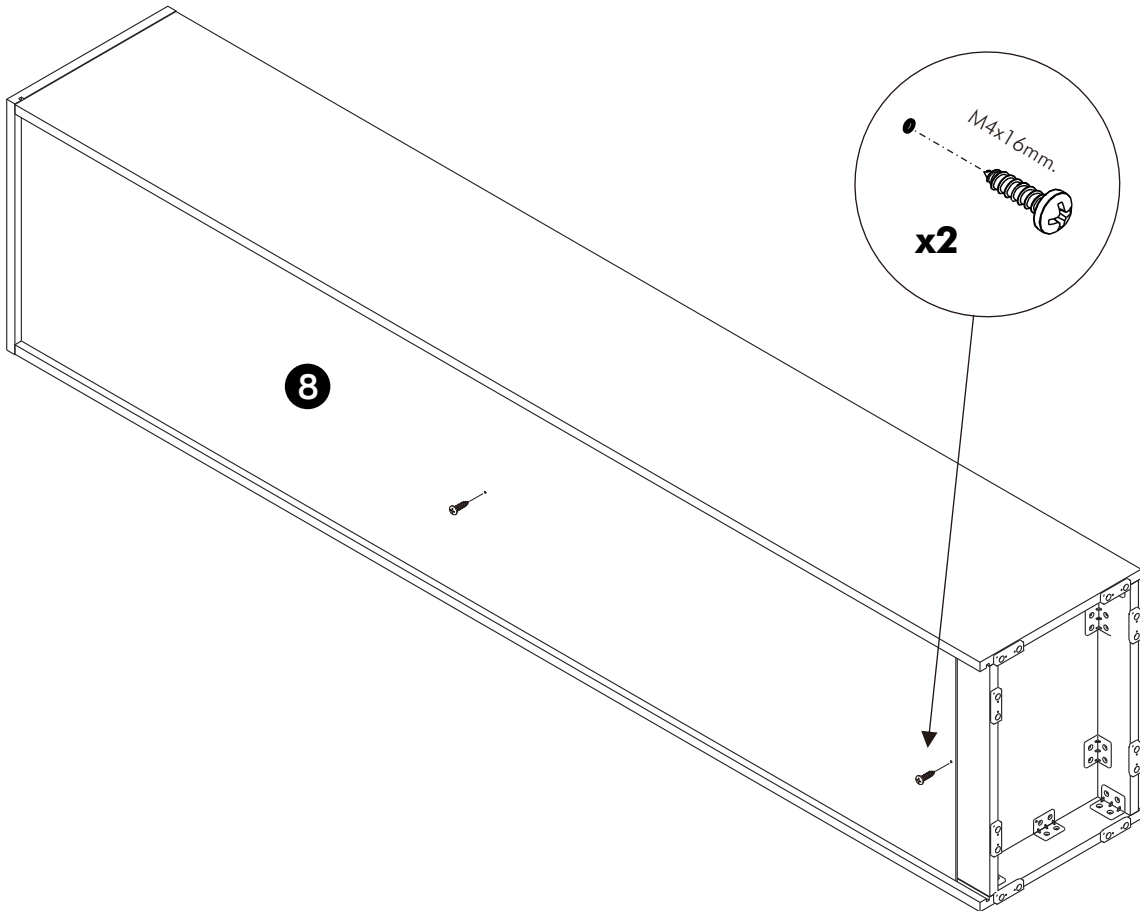

**5.**

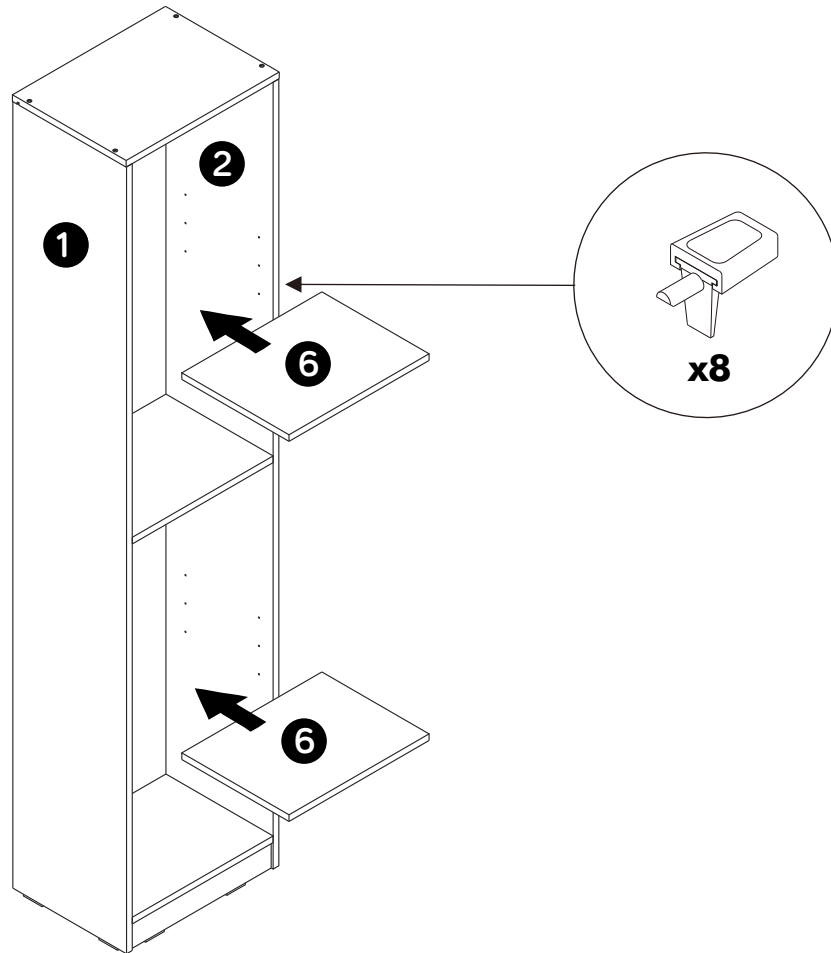

**6.**

