

WALK IN CLOSET (N125L)

PJ. RESERVE 61-2

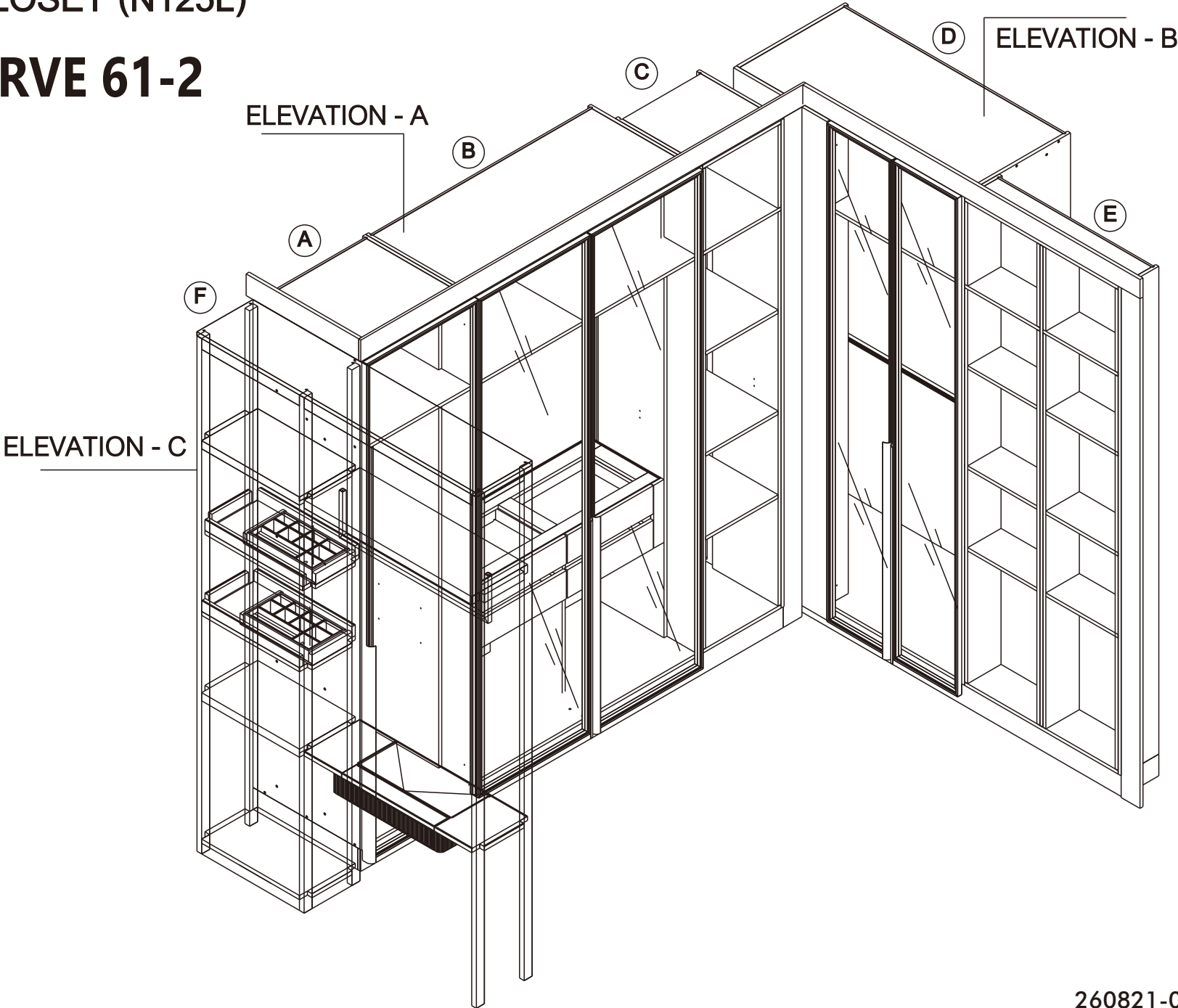

1.

ELEVATION - A

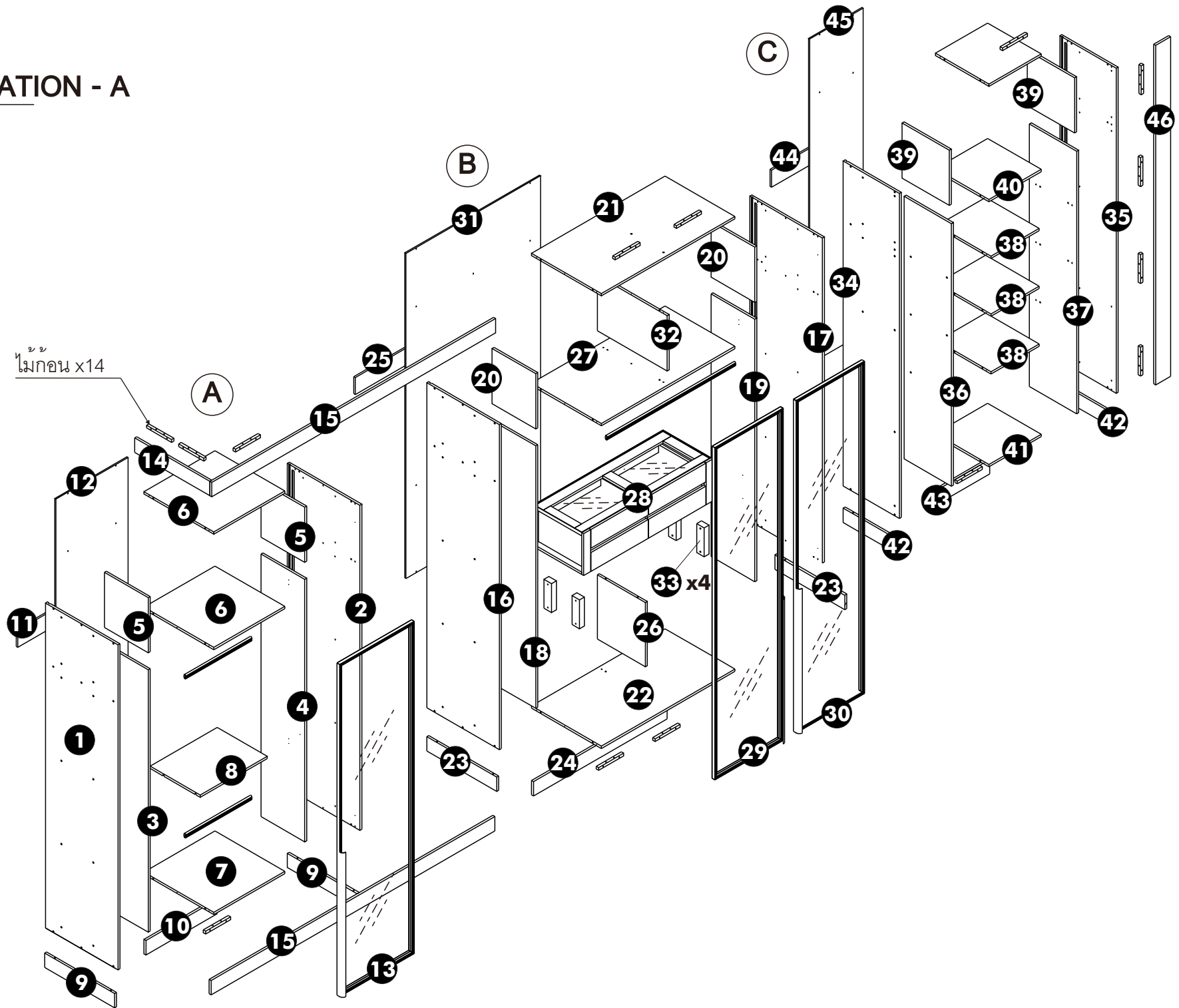

2.

ELEVATION - B

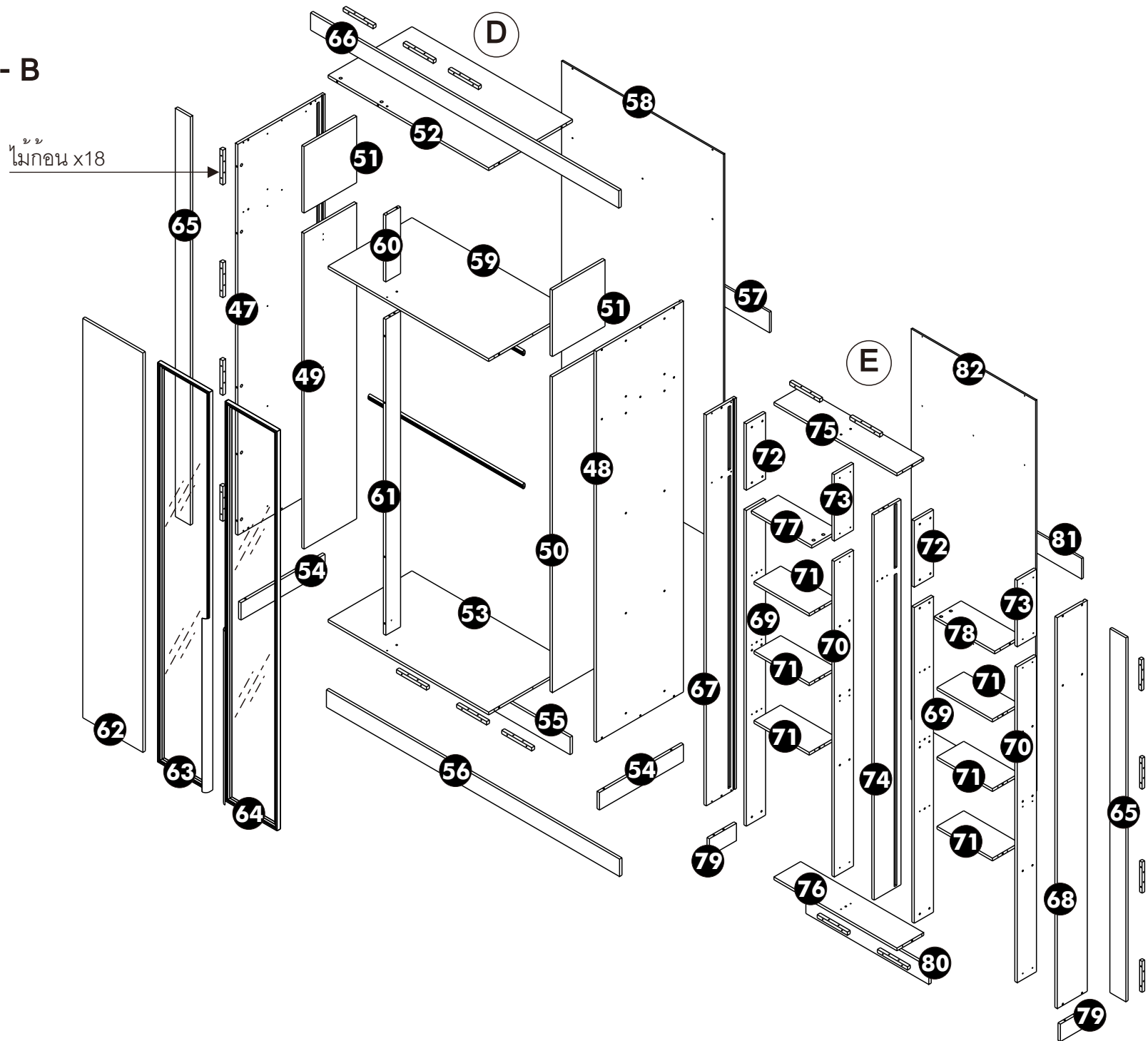

3.

ELEVATION - C

เหล็กยึดเสาอลู = 12

