

Model	160082678		
Creator	YUTHAPONG	.BCP Name	INDEX_C3D_KITCHEN2
Reviewer		Order	F000745
Approves		Date	12/03/2021

160082678-966X150X450

Colour

20.07=ML AE9V (MATT)

Edge

01.47=1MM WHITE

R&D REVIEW	
<input type="checkbox"/>	DWG.Customer
<input type="checkbox"/>	Work Report
<input type="checkbox"/>	Function
<input type="checkbox"/>	สินค้าตรงตัวอย่าง
ผู้ทบทวน _____	

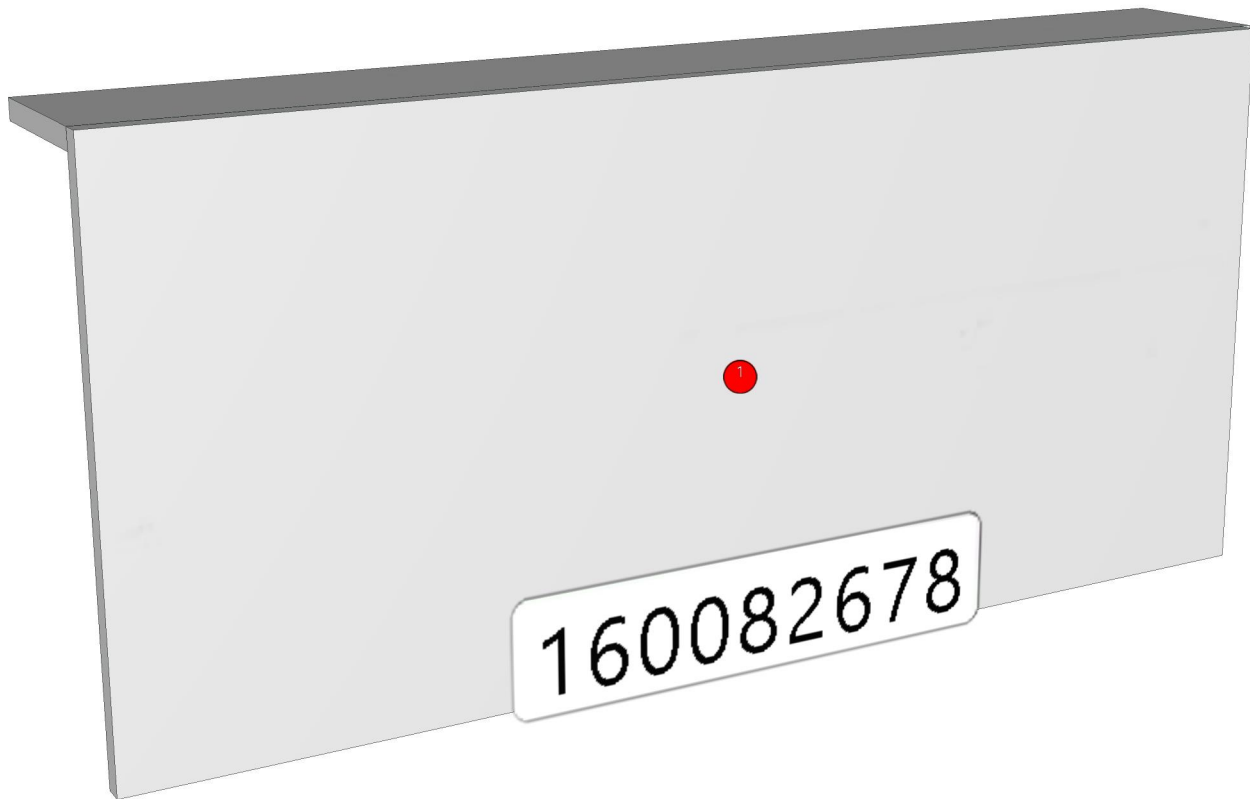

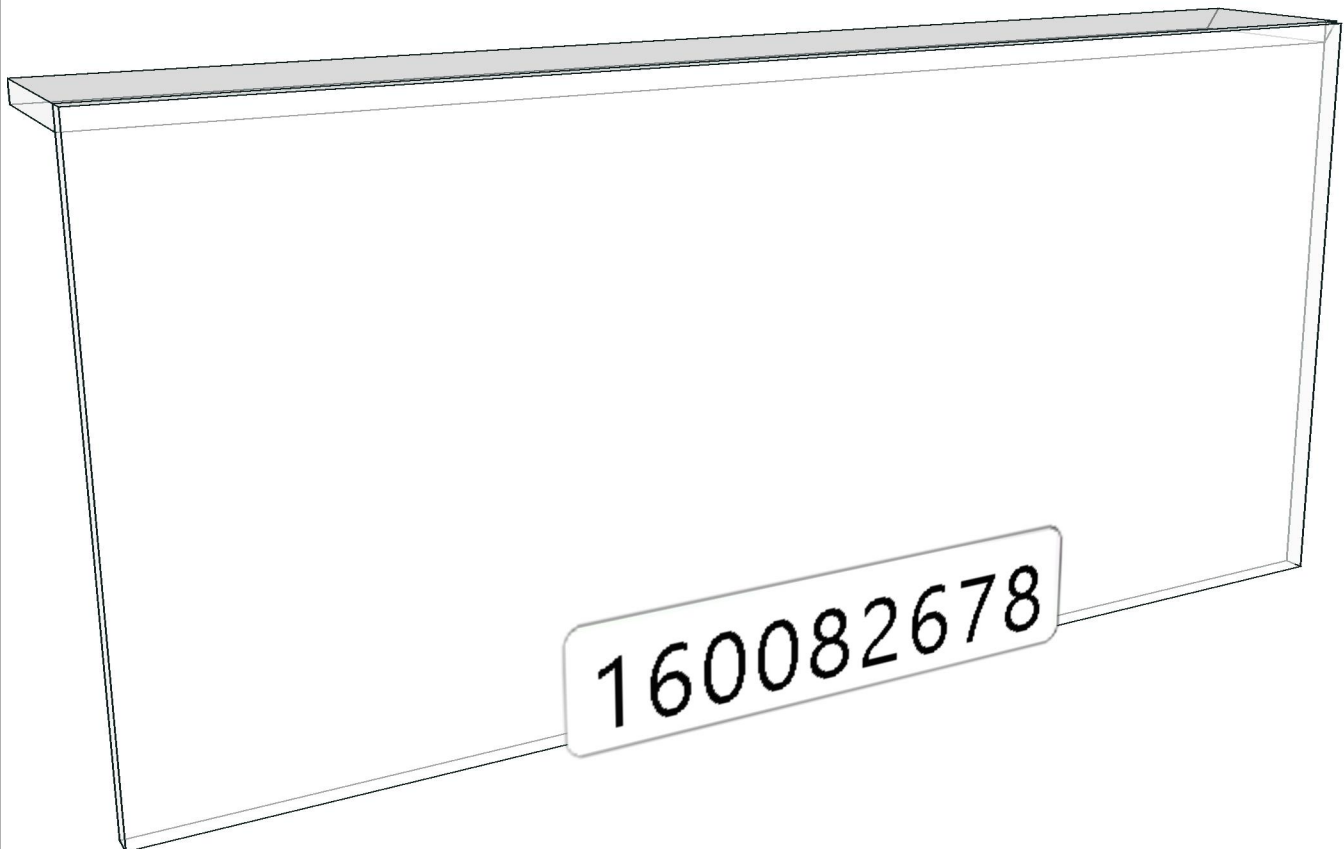
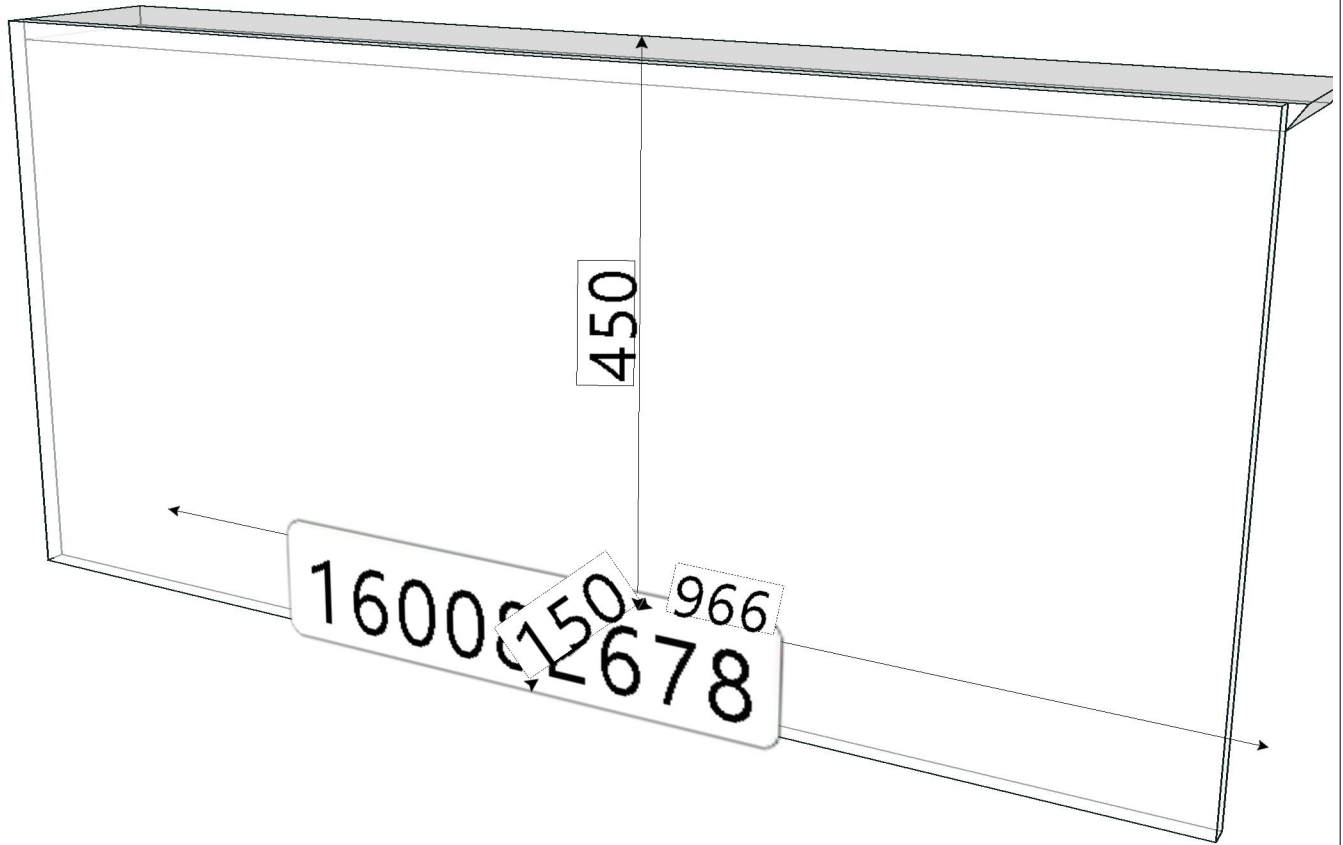

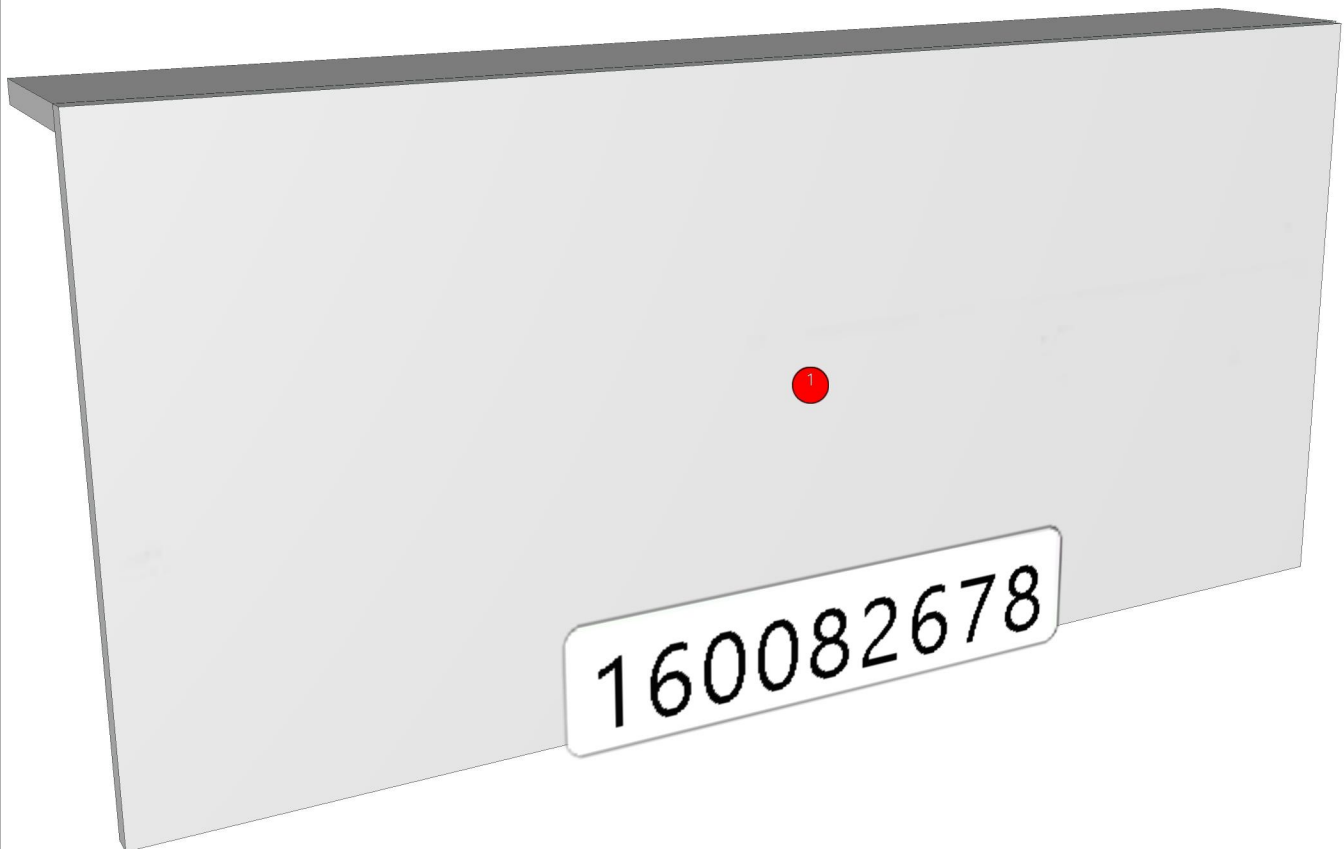
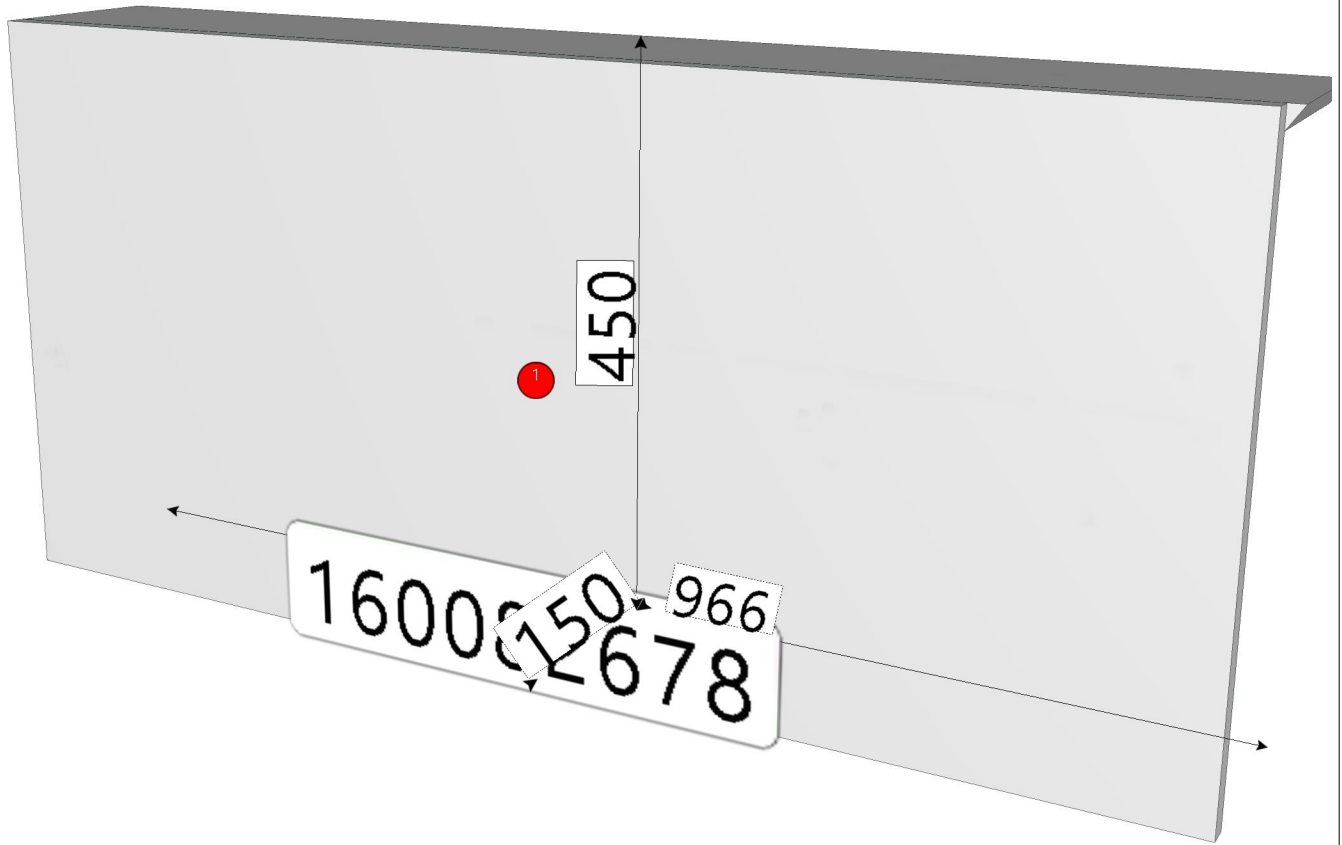

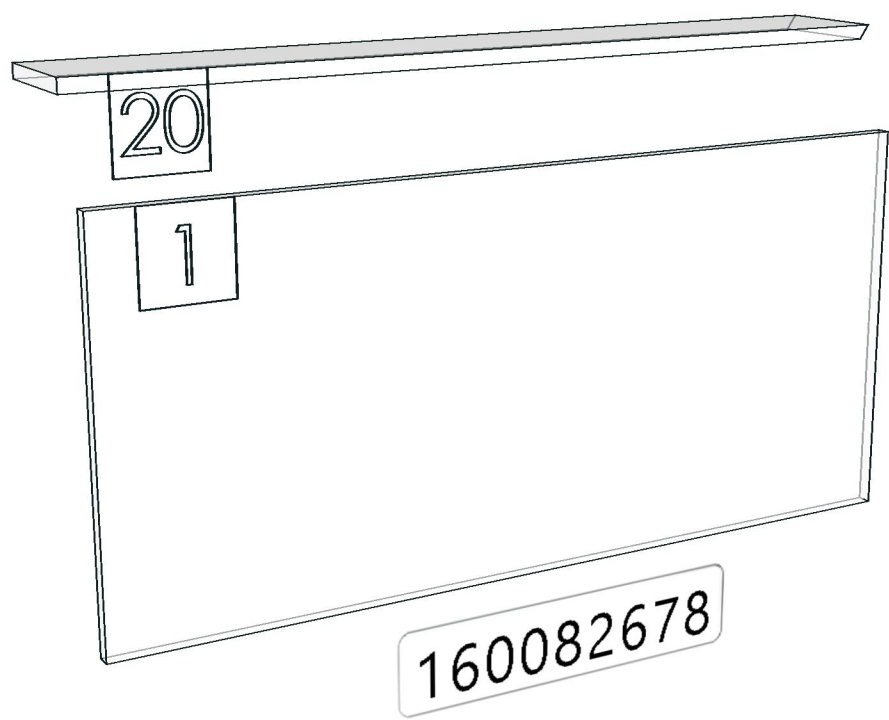
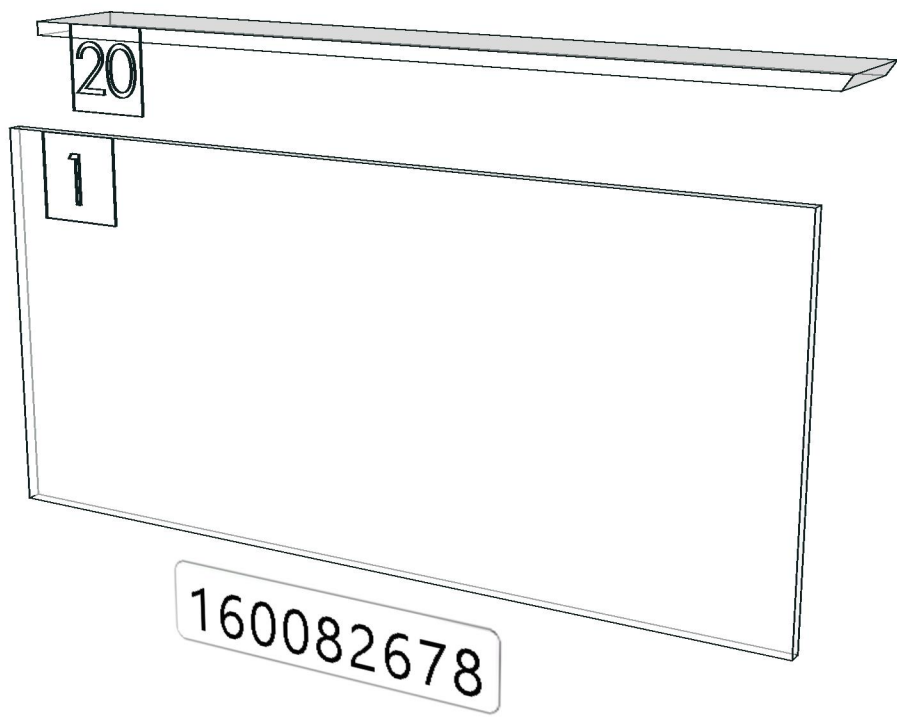

Model	160082678		
Creator	YUTHAPONG	.BCP Name	INDEX_C3D_KITCHEN2
Reviewer		Order	F000745
Approves		Date	12/03/2021

No.	Article No.	Description	Mat	Dimension	Cutting Size	Typepology	Skin
0	160082678			966x450x150			
	160082678-0-01	FRONT D BOX	PB-SP	16x966x450	16X964X448;L2:W2	624000 _STR=20.07 _EDG=WHITE-1	2
	160082678-0-2	TOP D BOX	PB-SP	16x134x966	16X133X964;L1:W2	626000 _STR=20.07 _EDG=WHITE-1	2

FITTING LIST

Qty per 1 set

No	New	Article fitting	List	Connect	Qty/Pcs				Cost / Qty	Sum Cost
					Spray	Ass	Pack	Sum		
0		160082678		966x450x150						
		3220300006	ไม้ก้อน MDF18x18x200 mm. ปิดผิว Dead Stock 2 หน้า				3	3		
		4120900074	ฝาปิดหัวสกรู(เดือยแฉก)สีขาว #00905				9	9		
		4121100027	จากพลาสติกใหญ่ สีขาว #00905				4	4		
		4130100118	สกรู C/B เกลียวดลอด F+M4x16 ซิงค์ขาว #0747				16	16		
		4130100124	สกรู C/B เกลียวดลอด F+M4x40 ซิงค์ขาว #0747				9	9		
		4130100147	สกรู C/B เกลียวดลอด P+M4x30 ซิงค์ขาว #0747				12	12		

No	Date	REVISION RECORD	REMARK	Create	YUTHAPONG	date:12/03/2021	Product name : -
4				Revivewer		date:	Article: TYPE:
3				Approves		date:	
2				Design			Customer: Indexlivingmall
1	12/03/2021	First departure		Name&Art			No:
INTERFURN INDEX INTERFURN CO.LTD Document control FR-RD-004 : REV#00:24/04/60							Page 3