

# ITALIVING

**Glass drawer dr W60H30**

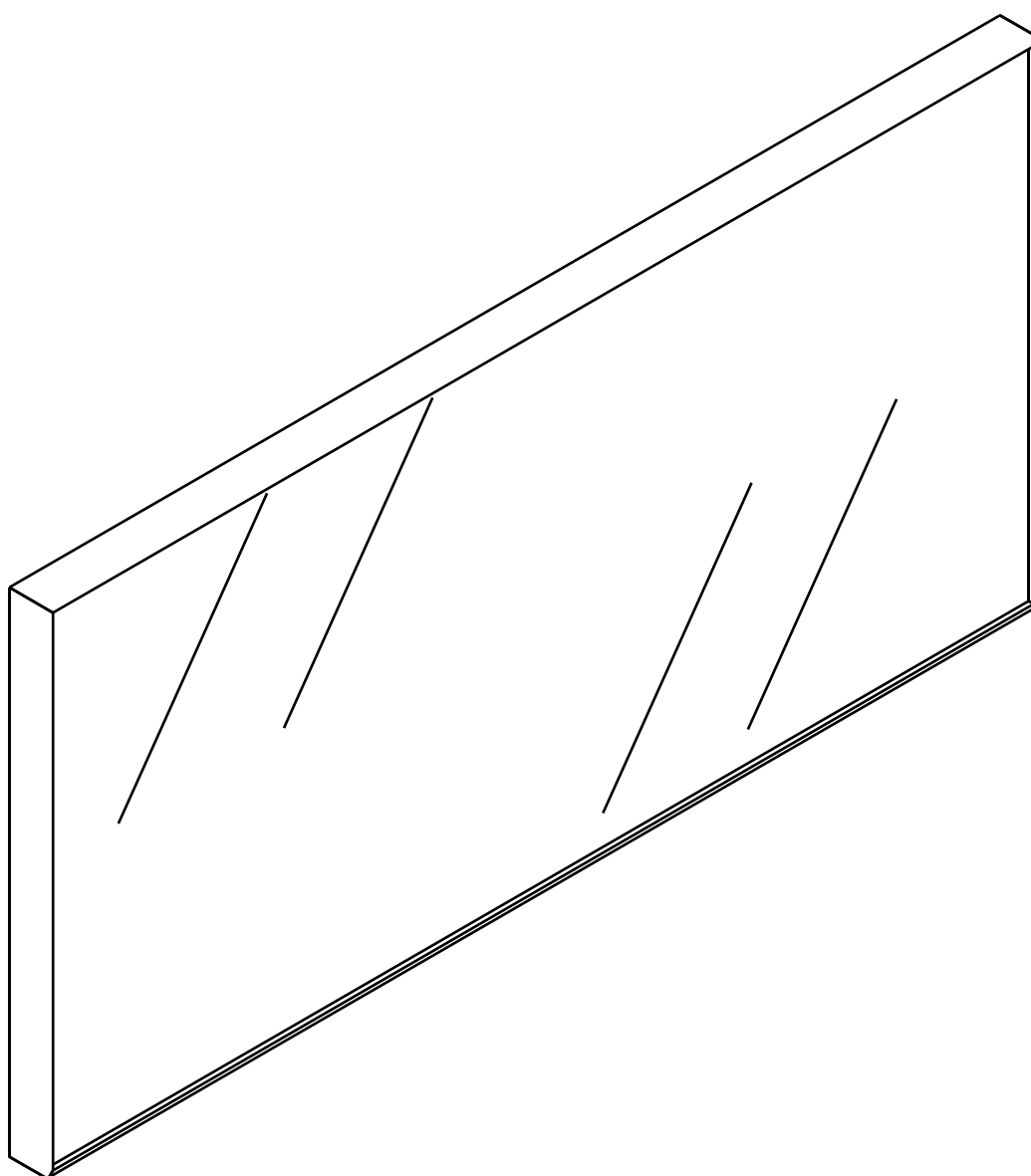

# CONNECT SYSTEM



M4x16mm.

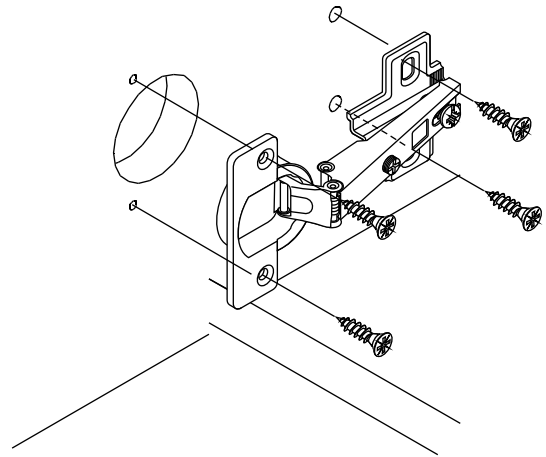
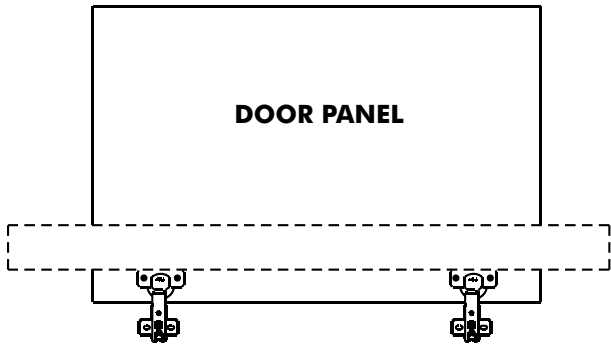

**HARDWARE**

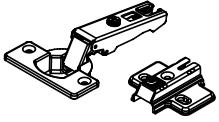

**x 2**

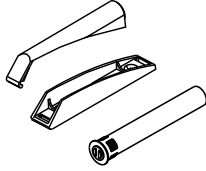

**x 1**



**x 1**



M4x16mm.

**x 8**



#5x1/2".

**x 1**



#5x5/8"

**x 2**

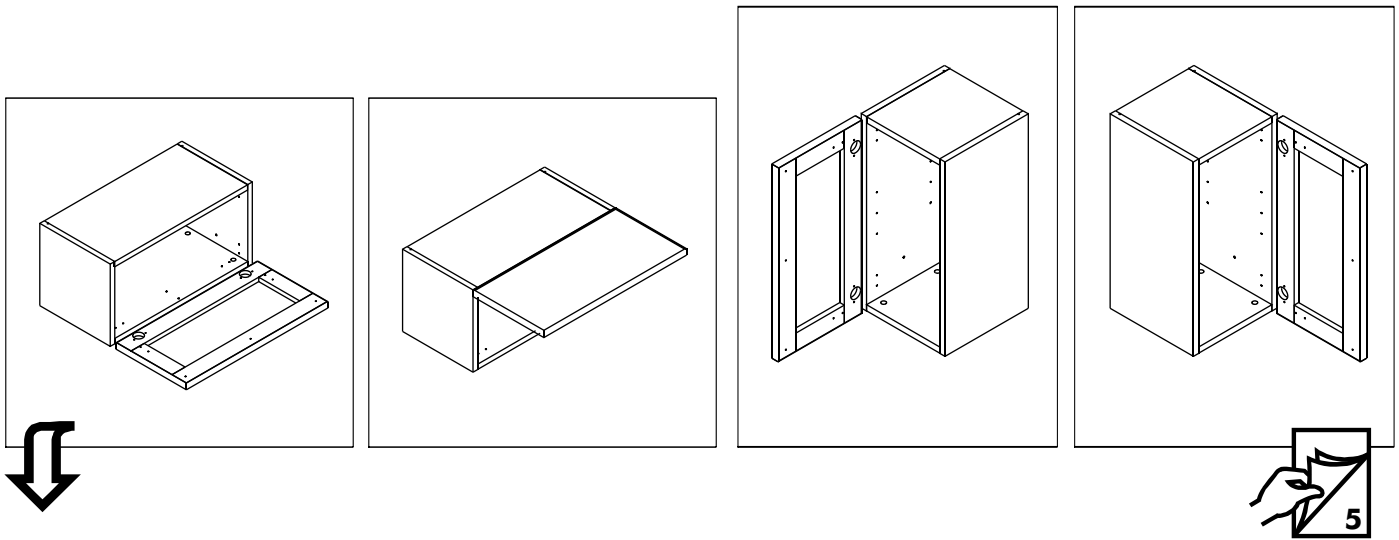

1.

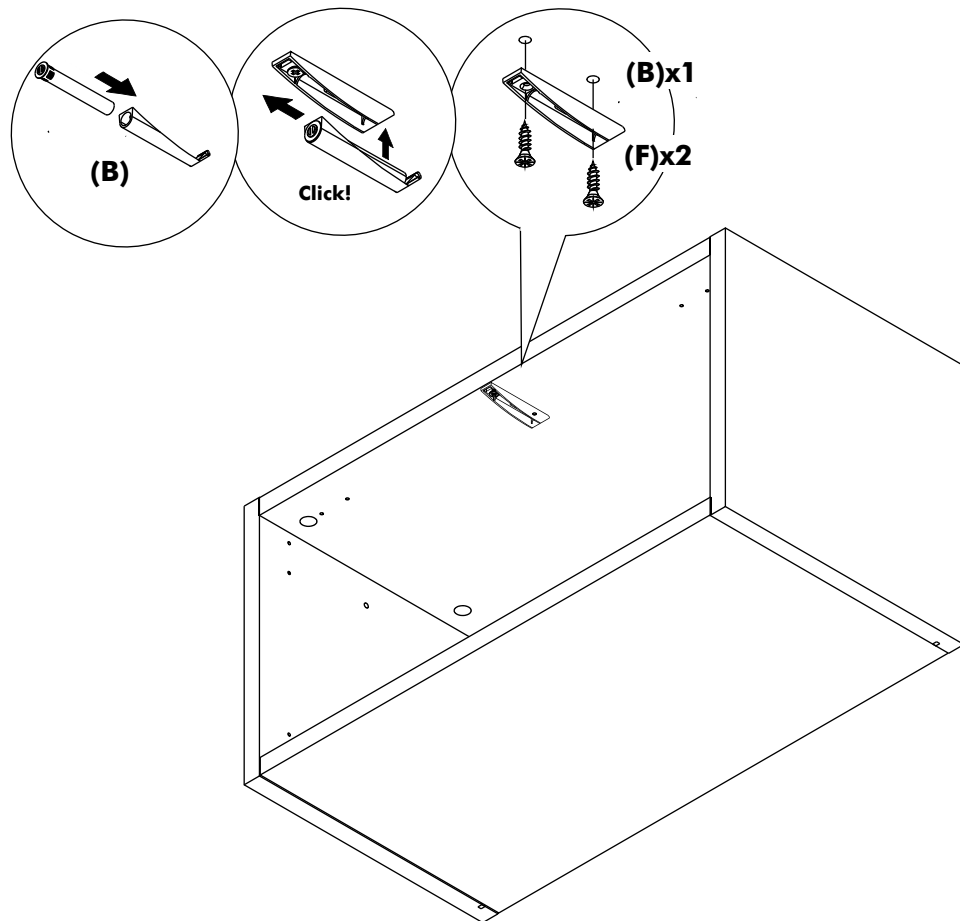

**2.**

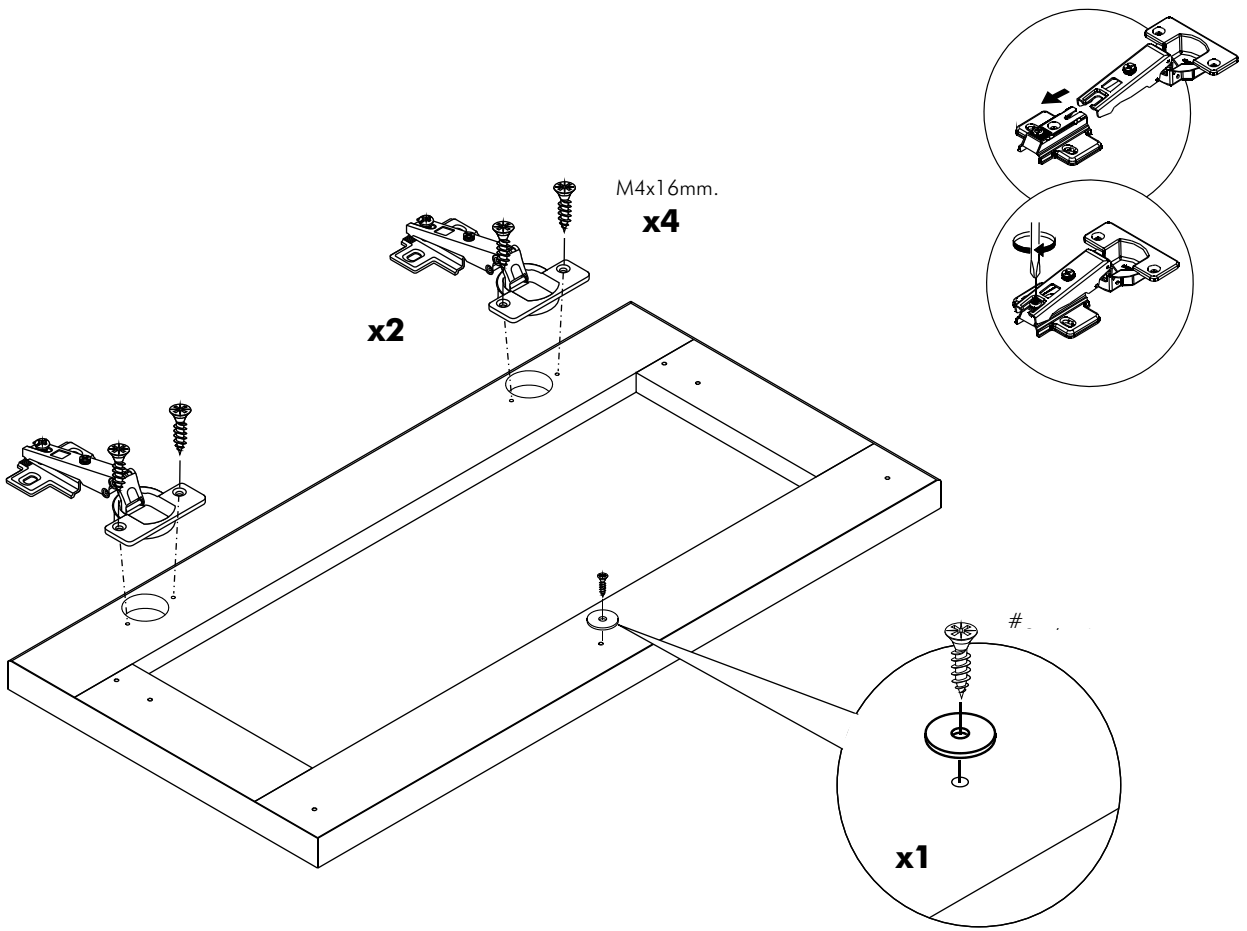

**3.**

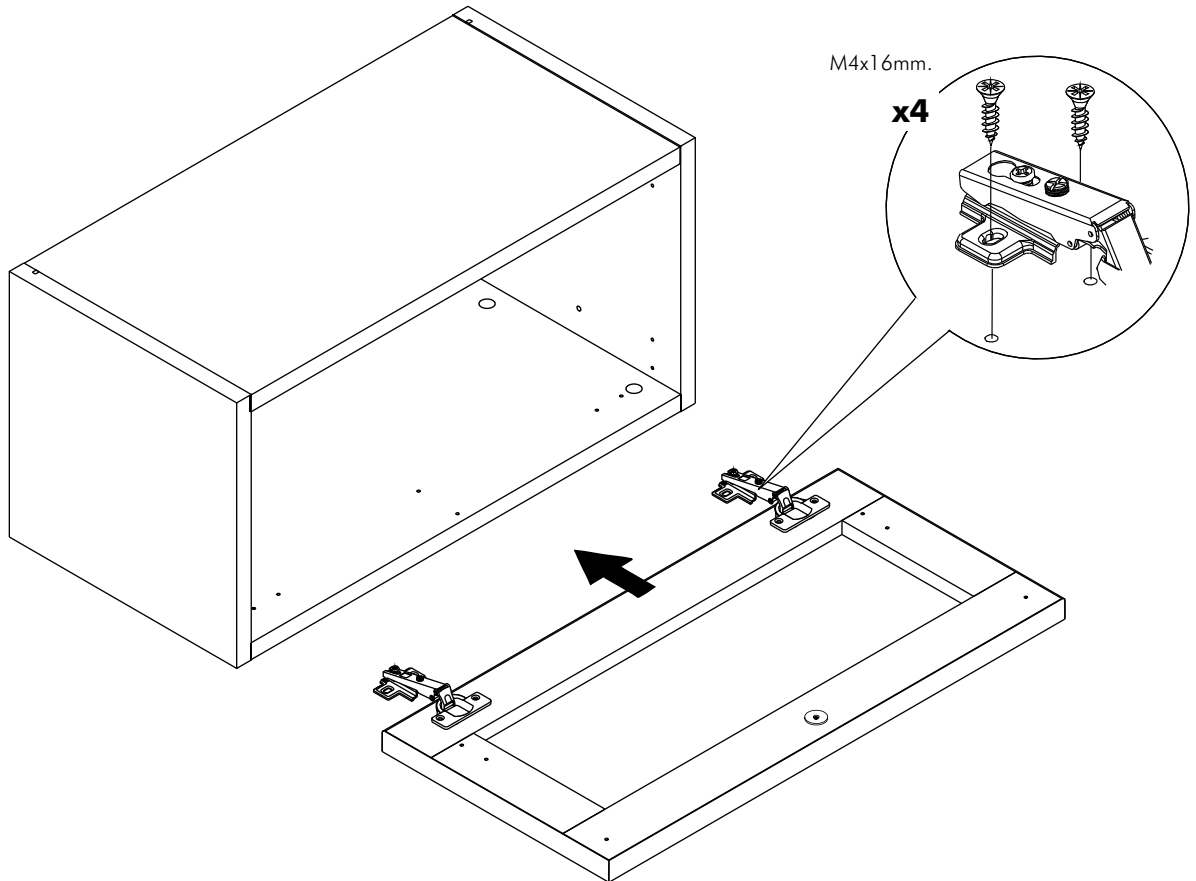

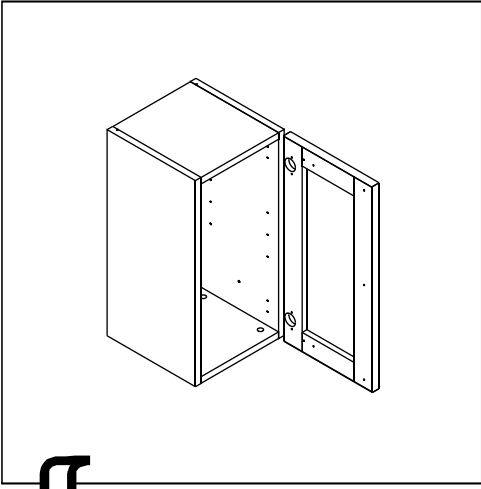

**1.**

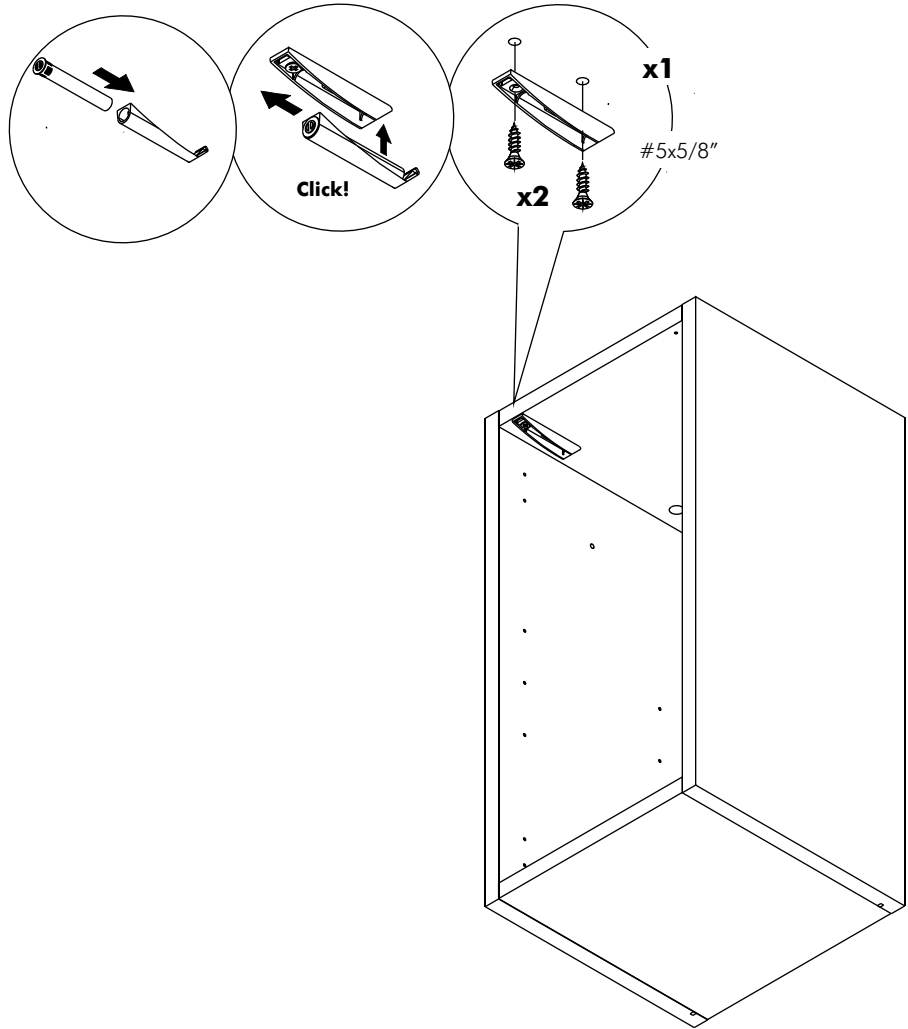

**2.**

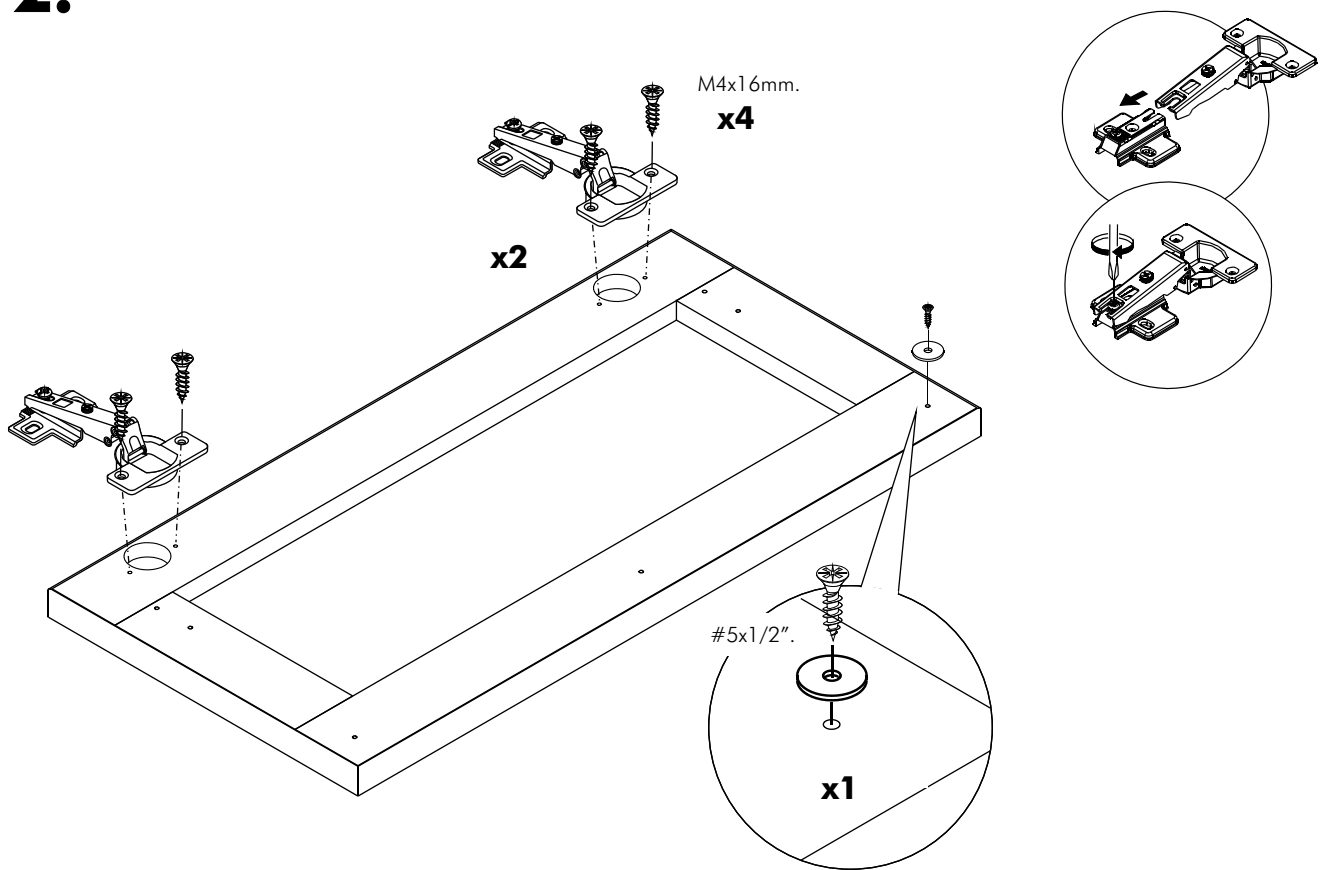

**3.**

