

ITAL-SMART

Top box 100cm/57

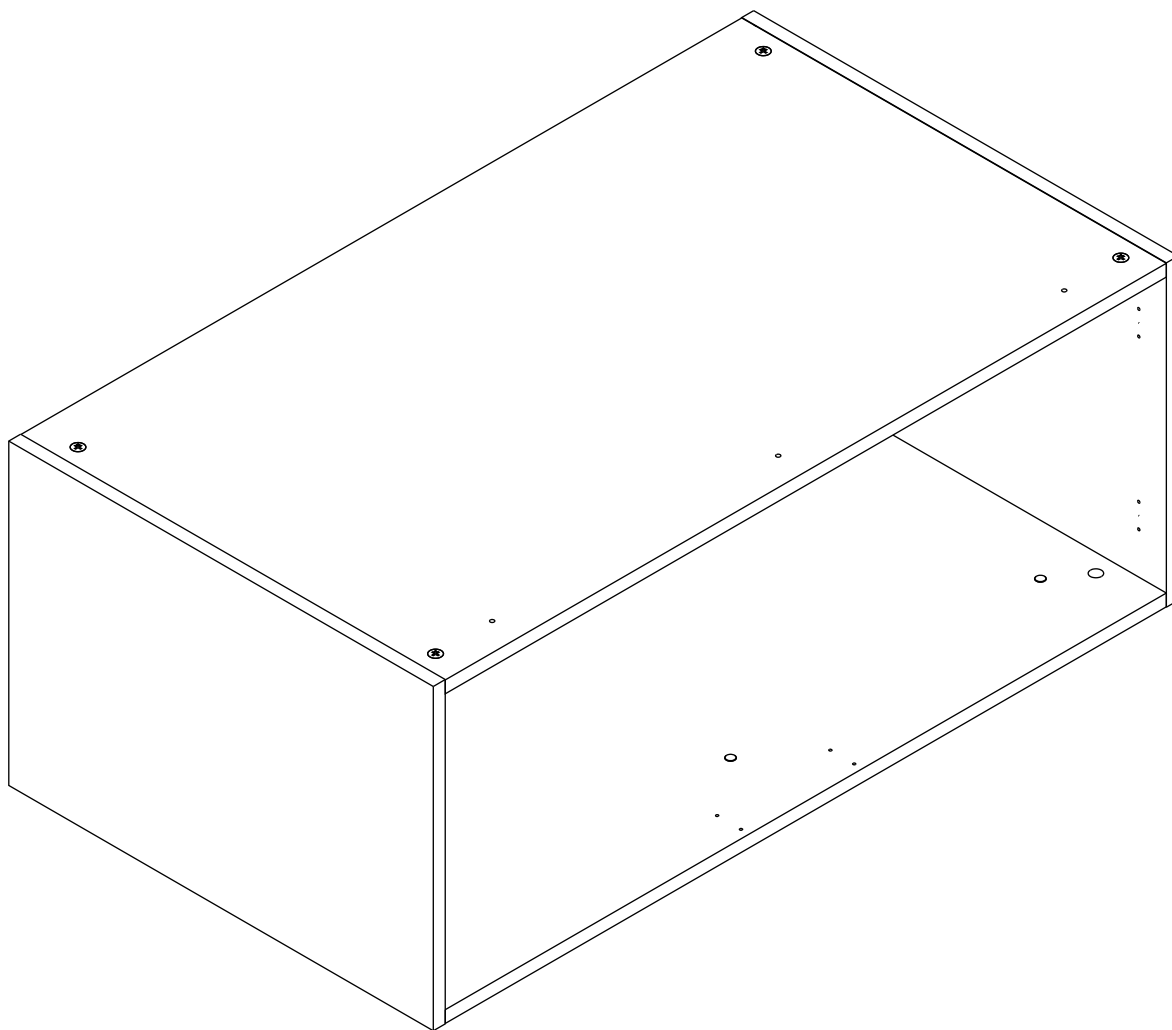

CONNECT SYSTEM

1

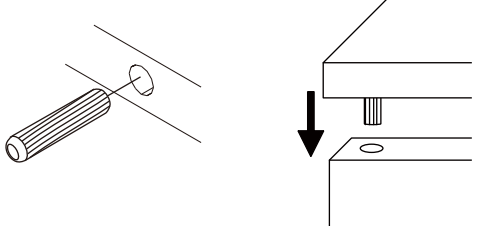

2

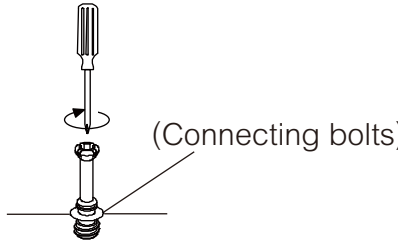

(Connecting bolts)

3

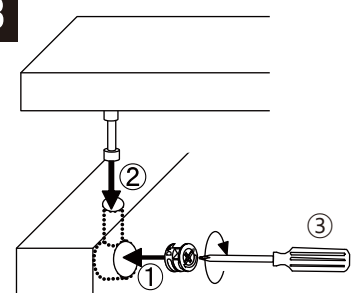

WHEN FITTING CAMS
ENSURE STARTING POSITION IS CORRECT
BEFORE YOU INSERT CONNECTING BOLT
TURN CLOCKWISE UNTIL SECURE

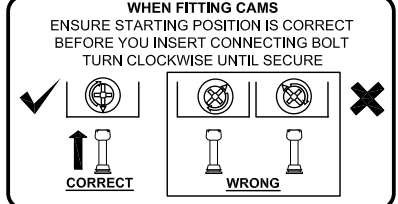

✓ CORRECT

✗ WRONG

HARDWARE

-BODY SET

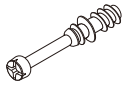

X 8



X 8

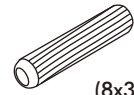

(8x35)

X 8



Ø11mm.

X 13



X 6



M4x20mm.

X 8



M4x25mm.

X 11



Ø13mm.

X 2

PART

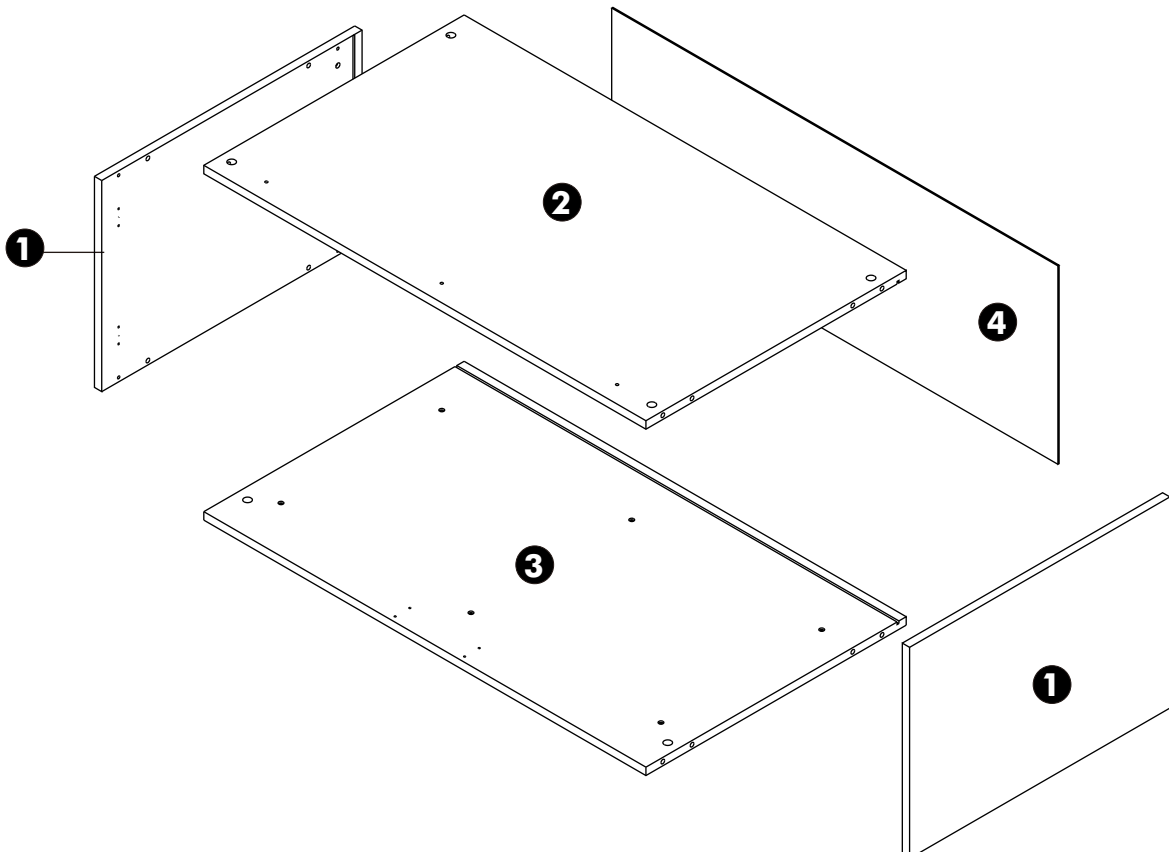

1.

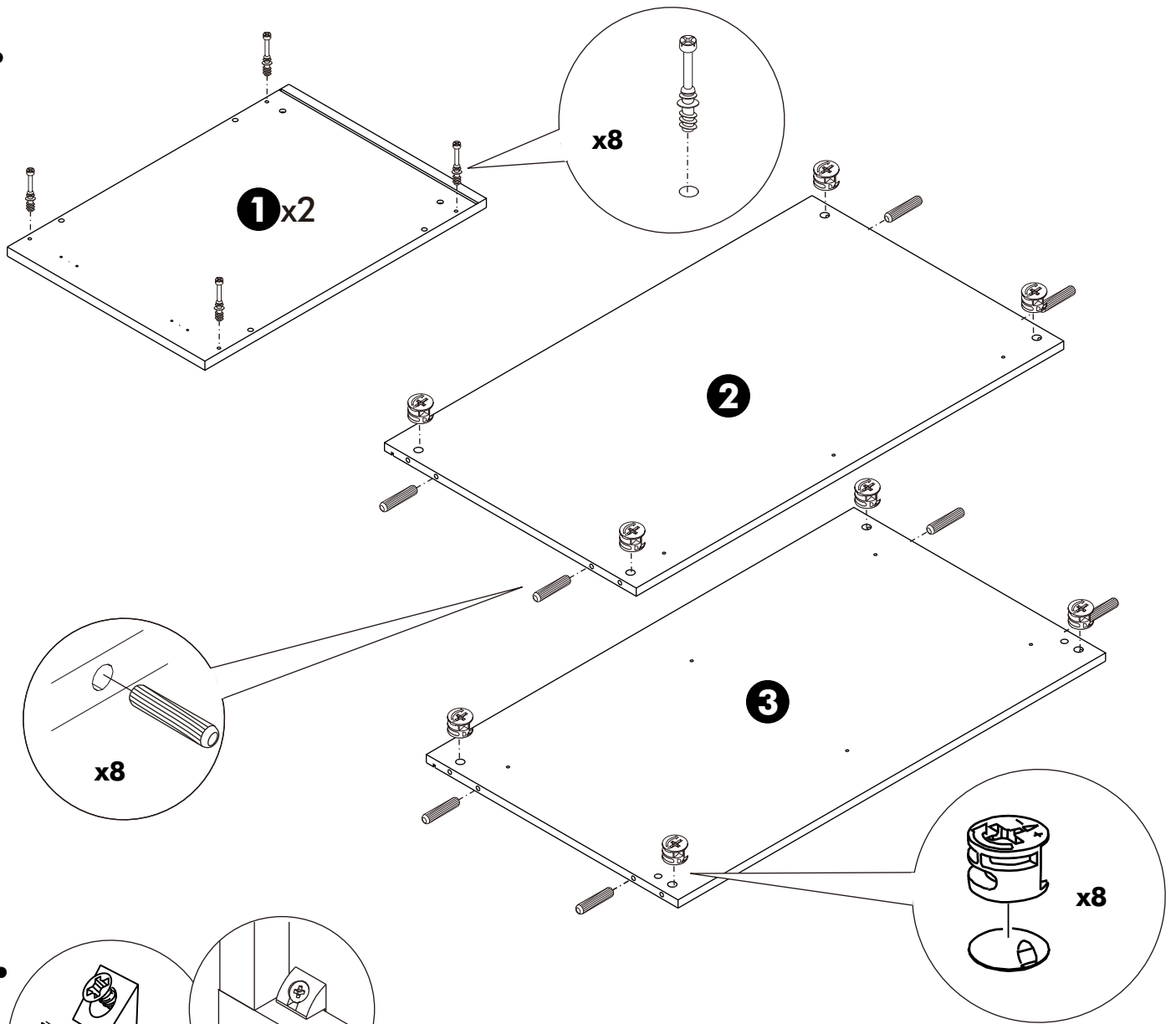

2.

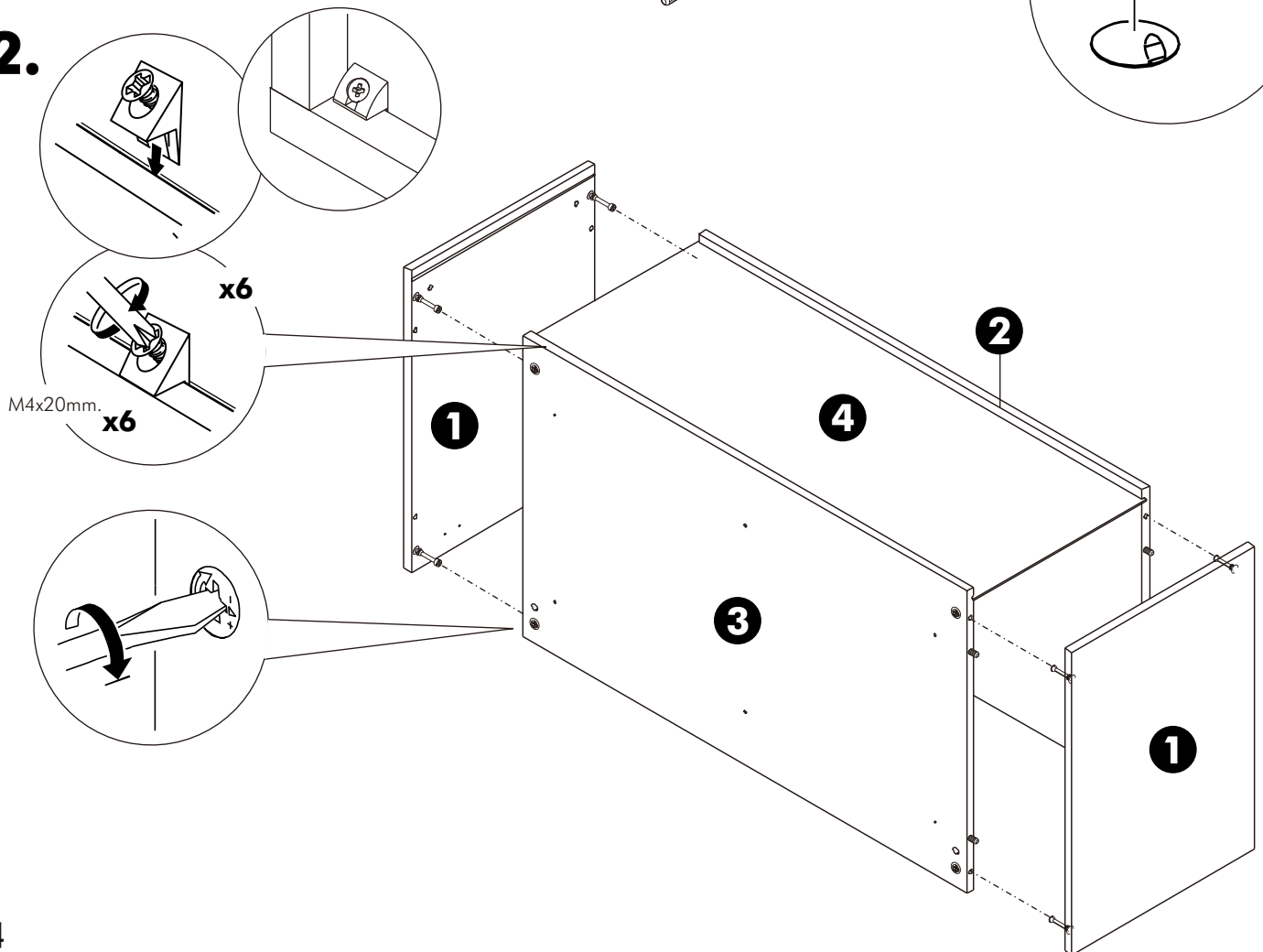

3.

