

PUZZLE/P

Low glass door / 40cm.

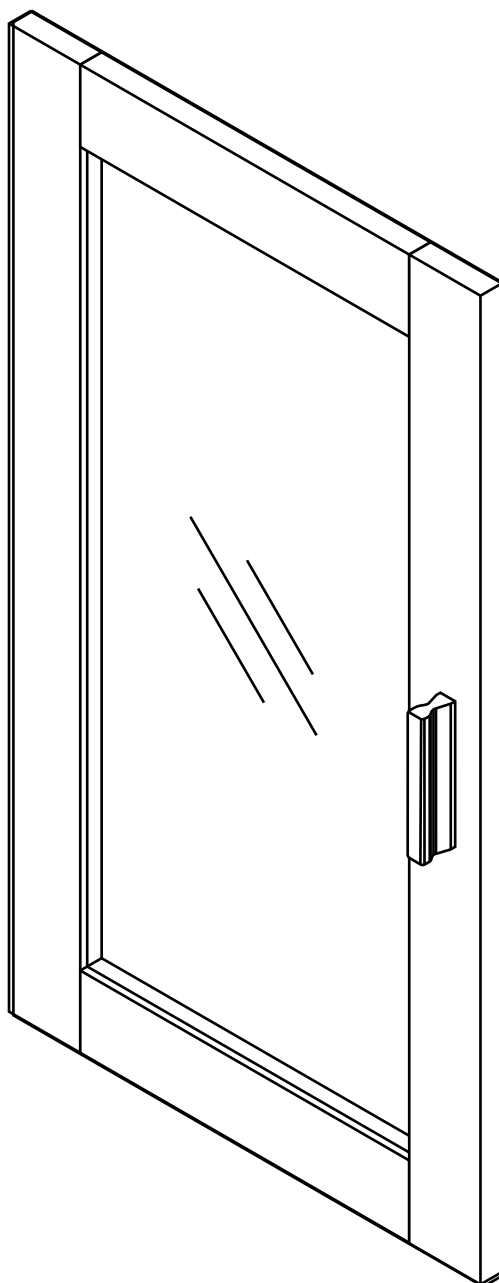

HARDWARE

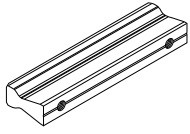

X 1

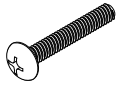

M4x22mm.

X 2

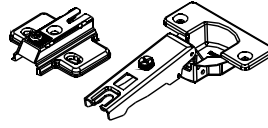

X 2



X 2

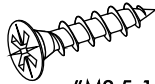

#M3.5x16(F)

X 4



FxB #M5x12/8

X 4

1.

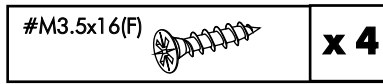
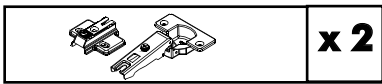
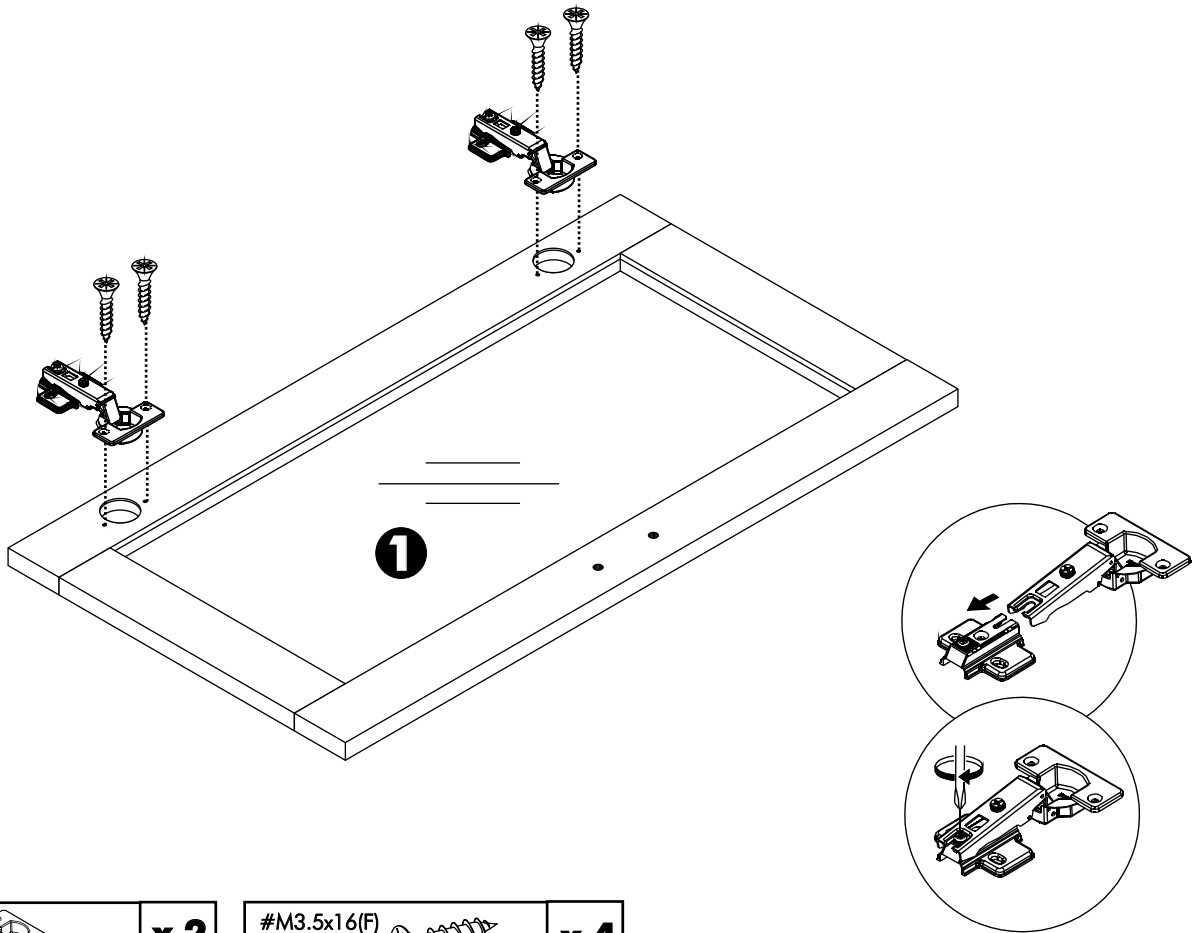

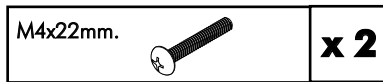
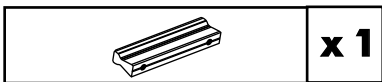
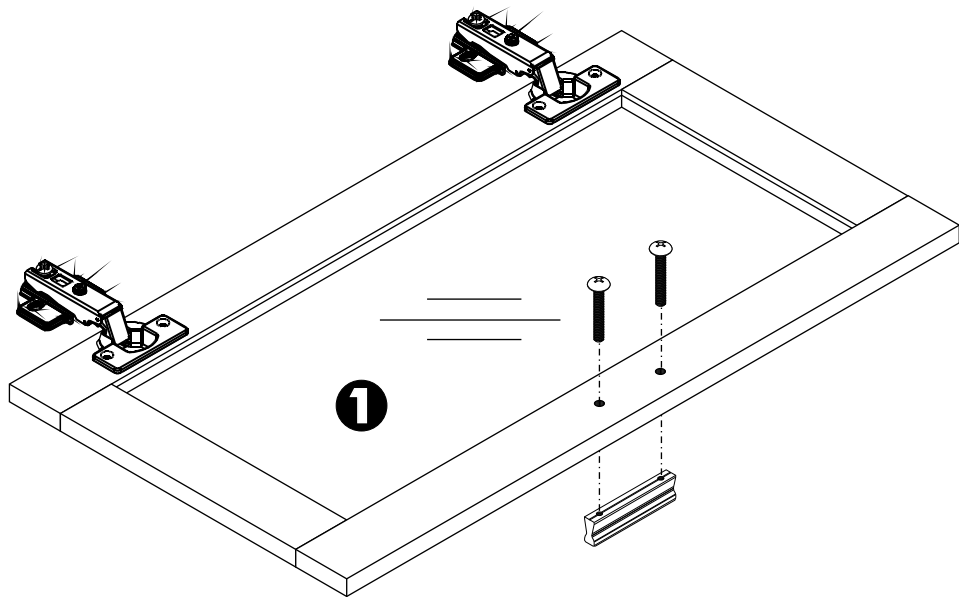

2.

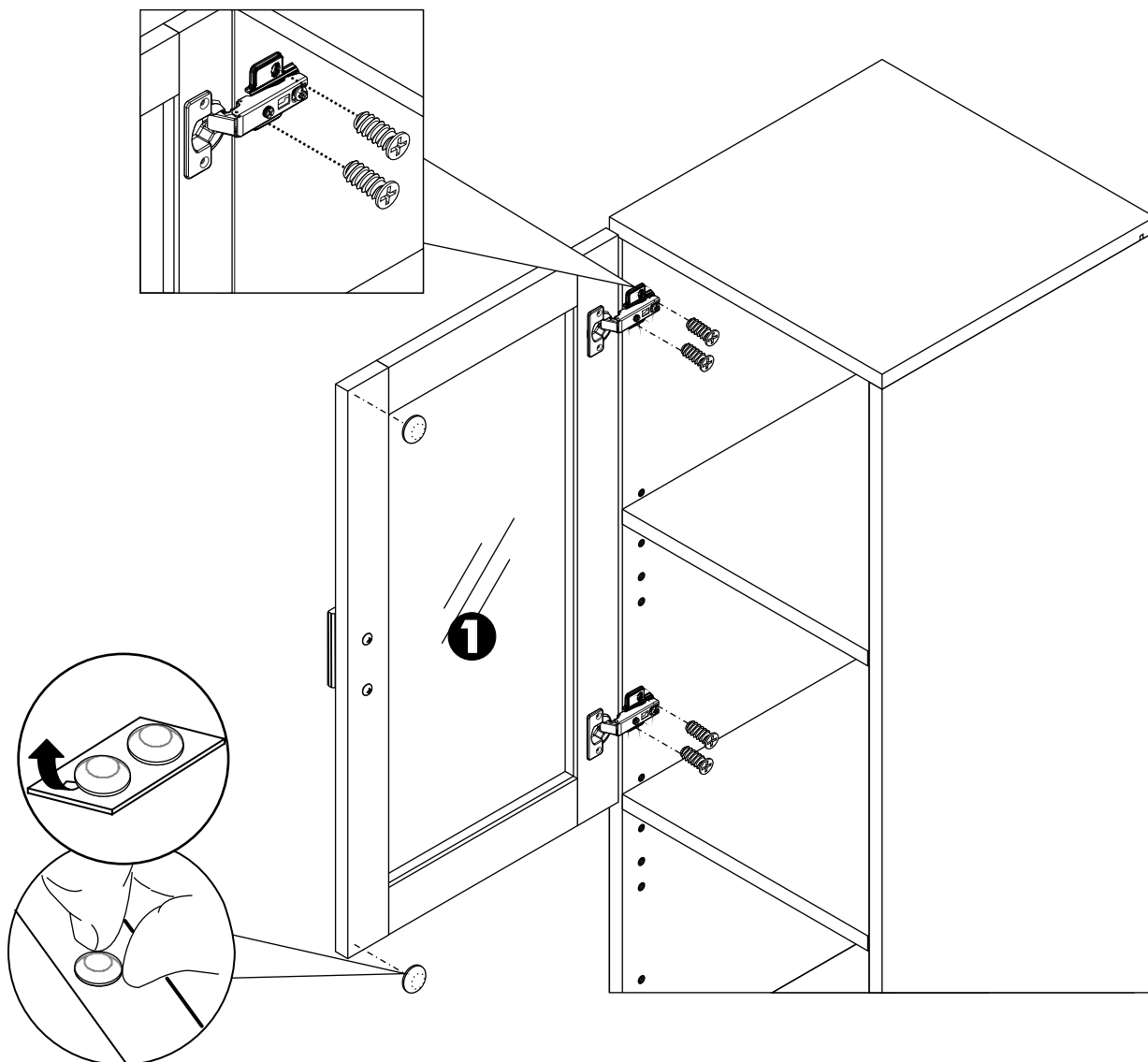

3.



	x 2
#M5x12/8 	x 4